

Toll Facilities Reference Manual



**CENTRAL
FLORIDA
EXPRESSWAY
AUTHORITY**

UPDATE DECEMBER 2019

TABLE OF CONTENTS

	<u>Page(s)</u>
Overview.....	i
Key Addresses and Telephone Numbers	i
E-PASS Service Center	i
Mainline Toll Plaza Information.....	ii-iv
Legend	v
SR 408 - Mainline Toll Plazas and Associated Tolled Ramps	1-19
SR 414 - Mainline Toll Plazas and Associated Tolled Ramps	20-23
SR 417 - Mainline Toll Plazas and Associated Tolled Ramps	24-40
SR 429 - Mainline Toll Plazas and Associated Tolled Ramps	41-51
SR 453 - Mainline Toll Plazas	52-53
SR 528 - Mainline Toll Plazas and Associated Tolled Ramps	54-61
SR 538 - Mainline Toll Plazas	62-64
SR 551 - Goldenrod - Mainline Toll Plaza.....	65-66
SR 552 - Mainline Toll Plaza and Associated Tolled Ramps	67-69

Central Florida Expressway Authority Toll Facilities Reference Manual

Overview

This Toll Facilities Reference Manual provides pertinent information in a condensed format relevant to the toll plazas on the Central Florida Expressway System.

Key Addresses & Telephone Numbers

The address and telephone number for the Central Florida Expressway Authority and the E-PASS Service Center are provided below. ***Please note that the information shown for the mainline plazas is for official business only.***

Central Florida Expressway Authority
4974 ORL Tower Road
Orlando, FL 32807
407-690-5000
www.cfxway.com

E-PASS Service Center

Orlando East Service Center
762 S. Goldenrod Road
Orlando, FL 32822

Hours of Operation: 8:00 a.m. to 6:00 p.m. Monday through Friday
9:00 a.m. to 1:00 p.m. Saturday

E-PASS Service Center Phone Number: (407) 823-EPASS (823-7277) or 1-800-353-7277

Mainline Toll Plaza Information



SR 408 (East West Expressway)

Hiawassee Mainline Toll Plaza
8302 East West Expwy Hiawassee Main Plaza
Orlando, FL 32835



SR 408 (East West Expressway)

Pine Hills Mainline Toll Plaza
4700 East West Expwy Pine Hills Main Plaza
Orlando, FL 32808



SR 408 (East West Expressway)

Conway West Mainline Toll Plaza
4901 SR 408 (East West Expwy) Main Plaza
Orlando, FL 32807



SR 408 (East West Expressway)

Conway East Mainline Toll Plaza
5320 SR 408 (East West Expwy) Main Plaza
Orlando, FL 32807



SR 408 (East West Expressway)

Dean Mainline Toll Plaza
10500 East West Expwy Dean Main Plaza
Orlando, FL 32825



SR 414 (Apopka Expressway)

Coral Hills Mainline Toll Plaza
2401 State Road 414
Apopka, FL 32703



SR 417 (Central Florida GreeneWay)

John Young Parkway Mainline Toll Plaza
14200 GreeneWay
Orlando, FL 32837



SR 417 (Central Florida GreeneWay)

Boggy Creek Mainline Toll Plaza
13700 GreeneWay
Orlando, FL 32824

Mainline Toll Plaza Information



SR 417 (Central Florida GreeneWay)

Curry Ford Mainline Toll Plaza
5300 GreeneWay
Orlando, FL 32829



SR 417 (Central Florida GreeneWay)

University Mainline Toll Plaza
2600 GreeneWay
Orlando, FL 32817



SR 429 (Western Beltway)

Forest Lake Mainline Toll Plaza
3170 N. SR 429
Ocoee, FL 34761



SR 429 (Western Beltway)

Independence Mainline Toll Plaza
4002 SR 429
Winter Garden, FL 34787



SR 429 (Western Beltway)

Ponkan Mainline Toll Plaza
3150 W Ponkan Rd
Apopka, FL 32712



SR 429 (Western Beltway)

Plymouth Mainline Toll Plaza
6580 Mount Plymouth Rd
Apopka, FL 32712



SR 453 (Wekiva Parkway)

Coronado Mainline Toll Plaza
22500 Coronado Somerset Dr.
Sorrento, FL 32776

Mainline Toll Plaza Information



SR 528 (Beachline Expressway)

Dallas Mainline Toll Plaza

12799 SR 528

Orlando, FL 32833



SR 528 (Beachline Expressway)

Beachline Mainline Toll Plaza

12500 Beachline Expressway

Orlando, FL 32832

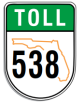

SR 538 (Poinciana Parkway)

Marigold Mainline Toll Plaza

MM: 3.0



SR 538 (Poinciana Parkway)

KOA Mainline Toll Plaza

MM: 5.5



SR 552 (Osceola Parkway)

Shingle Creek Mainline Toll Plaza

3451 W Osceola Pkwy

Kissimmee, FL 34741

LEGEND

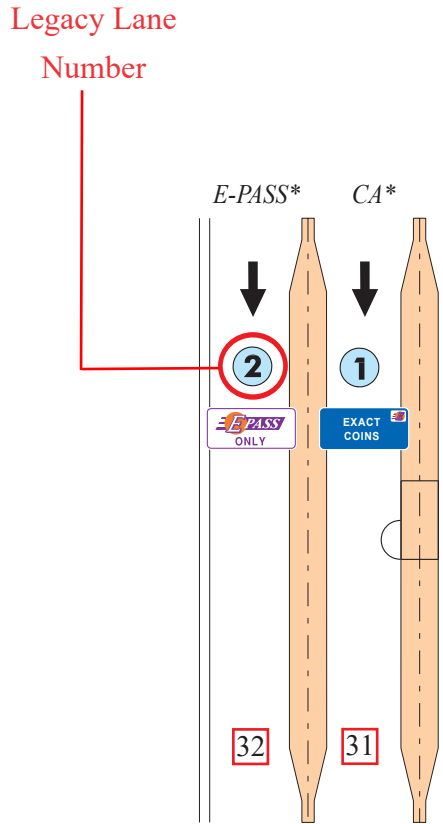
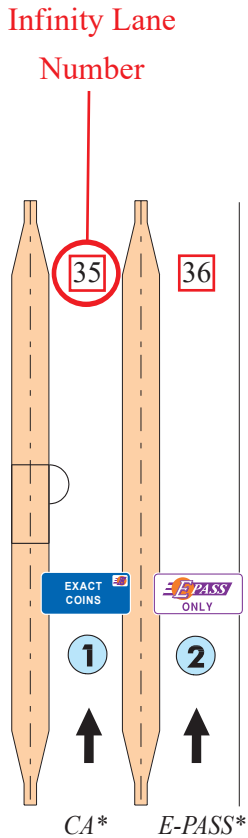

CFX Organizational ID and Mainline Facility

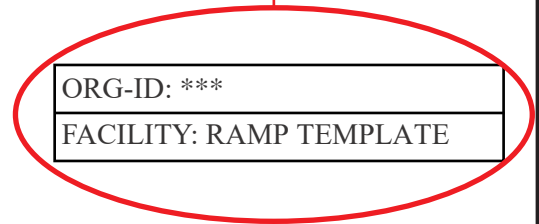

* Changeable Message Sign

OFF RAMP
R02
PID: ***

ON RAMP
R01
PID: ***

Note: All Changeable Message Signs (CMS) can display three messages: EXACT COINS, CHANGE RECEIPTS, E-PASS ONLY

Ramp Number and Infinity Plaza ID

Reports to Mainline Toll Plaza

T:\OCEANO\OCEA\MANUAL\Toll Facilities Reference Book\2016 Toll Manual - 3/10/16-CP

East-West Expressway

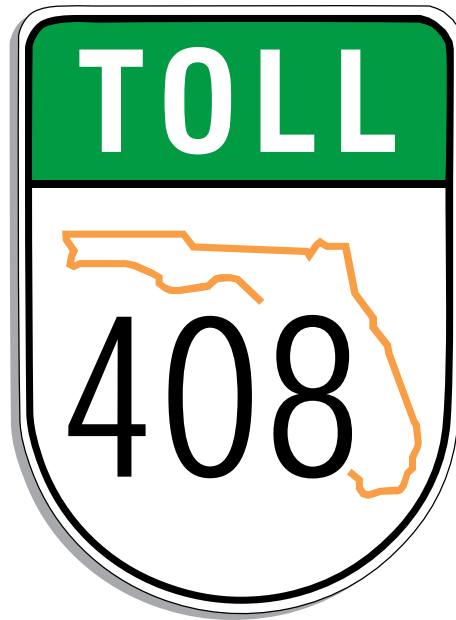

Mainline Toll Plazas and Associated Tolloed Ramps

LEGEND

For Lane Designations for all Plazas

CA - Exact Coin with E-PASS

MA - Change Receipts (Manned) with E-PASS

*ACM - Booth with Manual Lane Terminal,
Automatic Coin Machine and E-PASS*



To Florida's Turnpike & SR 50

Next Interchange: Good Homes Road

Admin. Bldg.

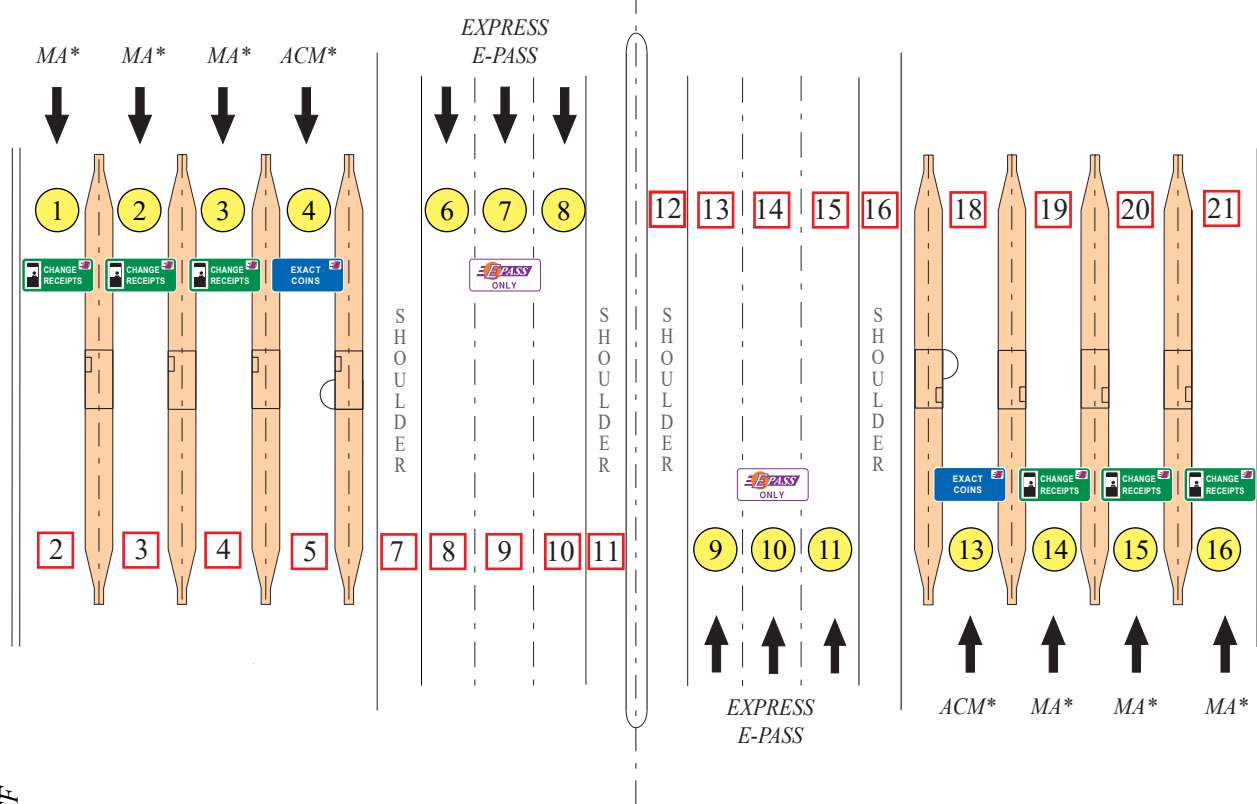

To I-4 (Downtown Orlando)

Next Interchange: Hiawasse Rd.
 Next Mainline Plaza: Pine Hills Mainline
 Next Ramp Plaza: Hiawasse Rd. EB-ON/
 WB-OFF

Note: All Changeable Message Signs (CMS) can display three messages: EXACT COINS, CHANGE RECEIPTS, E-PASS ONLY

ORG-ID: 5 PID: 320
 FACILITY: SR 408 - HIAWASSEE

- LANES OF EQUIPMENT
- 6 Manned Booth with E-PASS (MA)
 - 2 Booths with Automatic Coin Machines with E-PASS (ACM)
 - 6 Express E-PASS (E-PASS only)
 - * Changeable Message Sign

T:\DOCEA\DOCEA MANUAL\STol Facilities Reference Book\2016 Tolls Manual - 3/10/16-CP

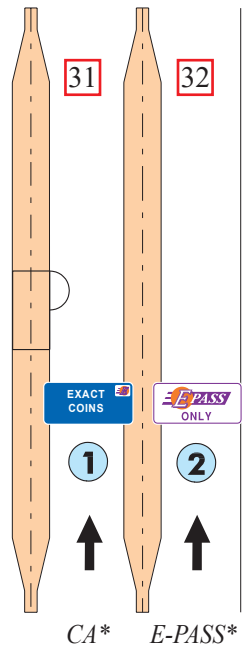
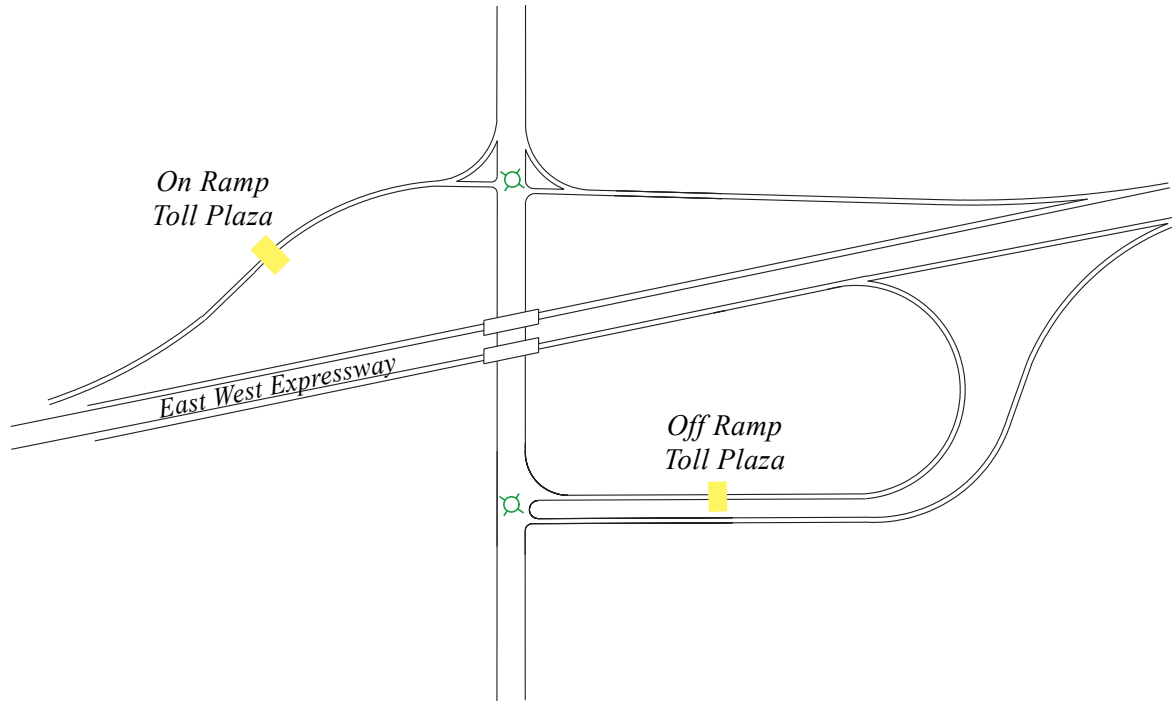

GOOD HOMES
ON RAMP
R01
PID: 390

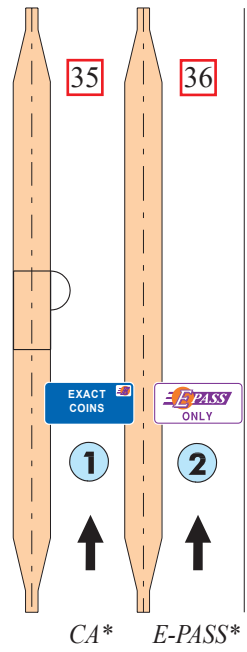

GOOD HOMES
OFF RAMP
R02
PID: 391

ORG-ID: 5
FACILITY: SR 408 - HIAWASSEE

* Changeable Message Sign

Note: All Changeable Message Signs (CMS) can display three messages: EXACT COINS, CHANGE RECEIPTS, E-PASS ONLY

Reports to Hiawassee Mainline Toll Plaza

T:\OCEA\OCEA MANUAL\STol Facilities Reference Book\2016 Tolls Manual - 3/10/16-CP

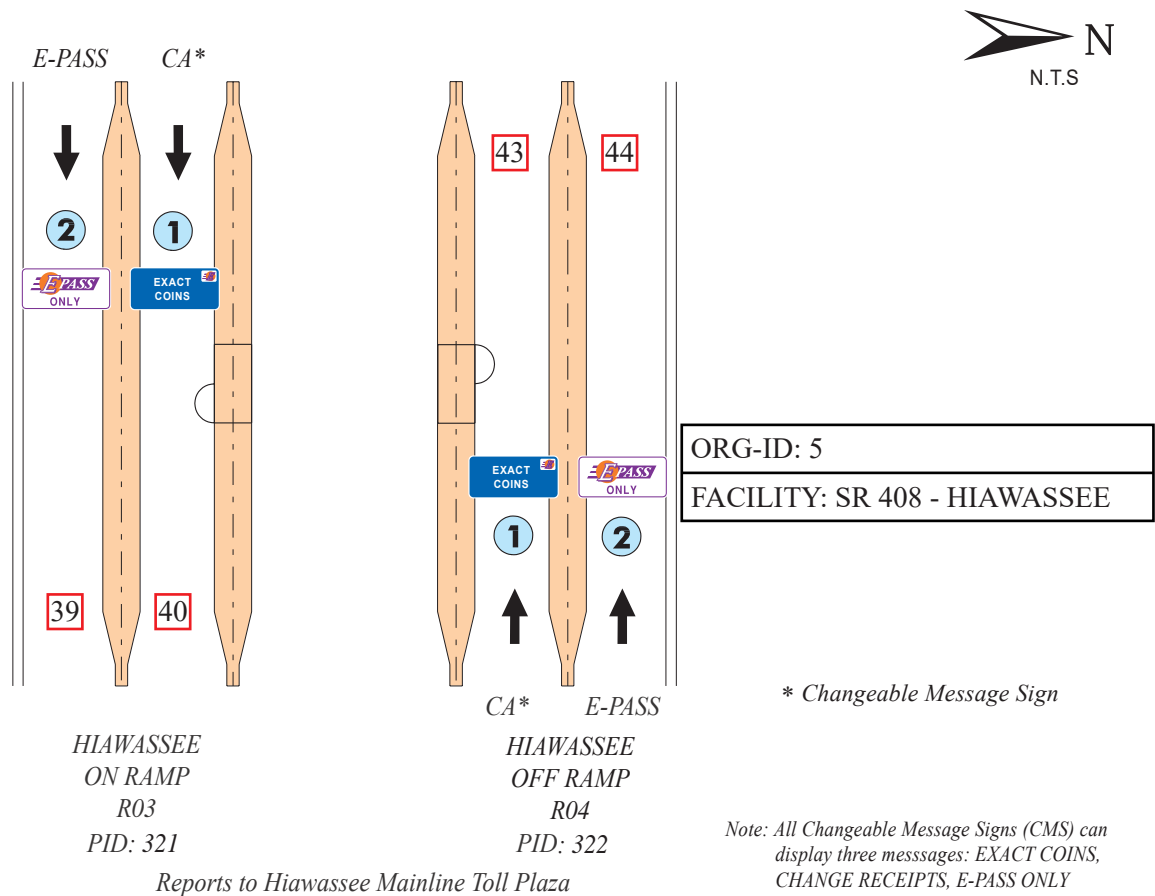
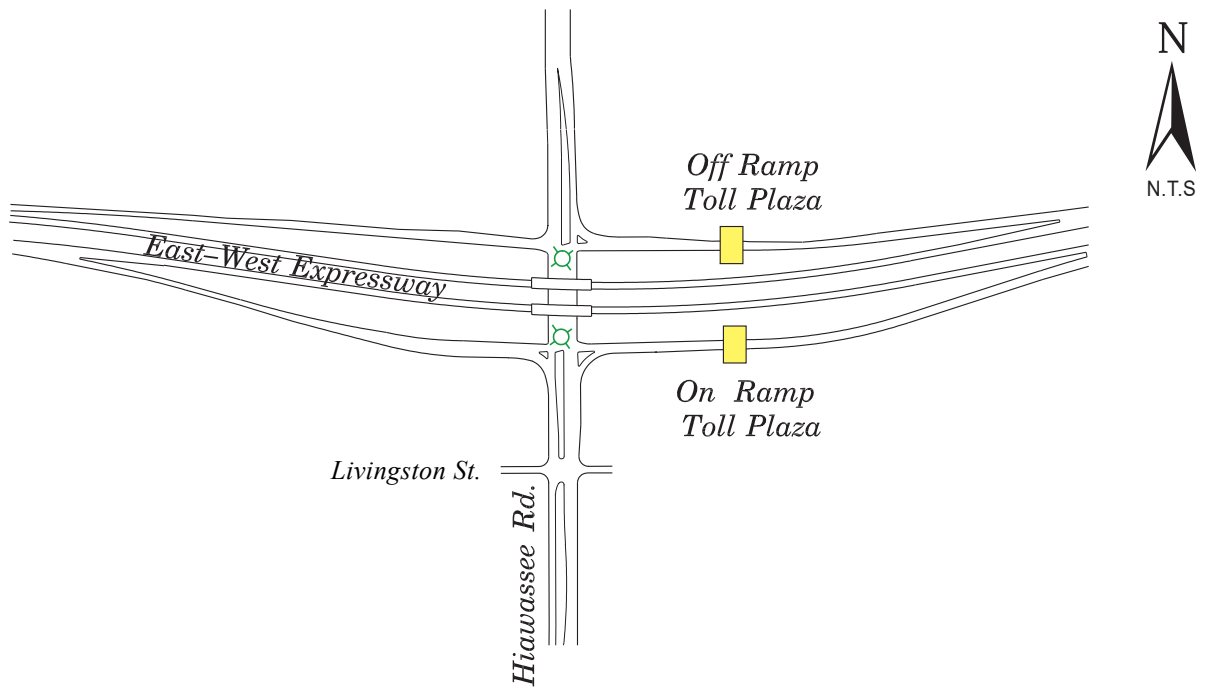

T:\OCEA\OCEA MANUAL\STol Facilities Reference Book\2016 Tolls Manual - 3/10/16-CP



To Florida's Turnpike

Next Interchange: Pine Hills Rd.

Next Mainline Plaza: Hiwassee Mainline

Next Ramp Plaza: Hiwassee Rd. EB-ON/
WB-OFF



Admin. Bldg.

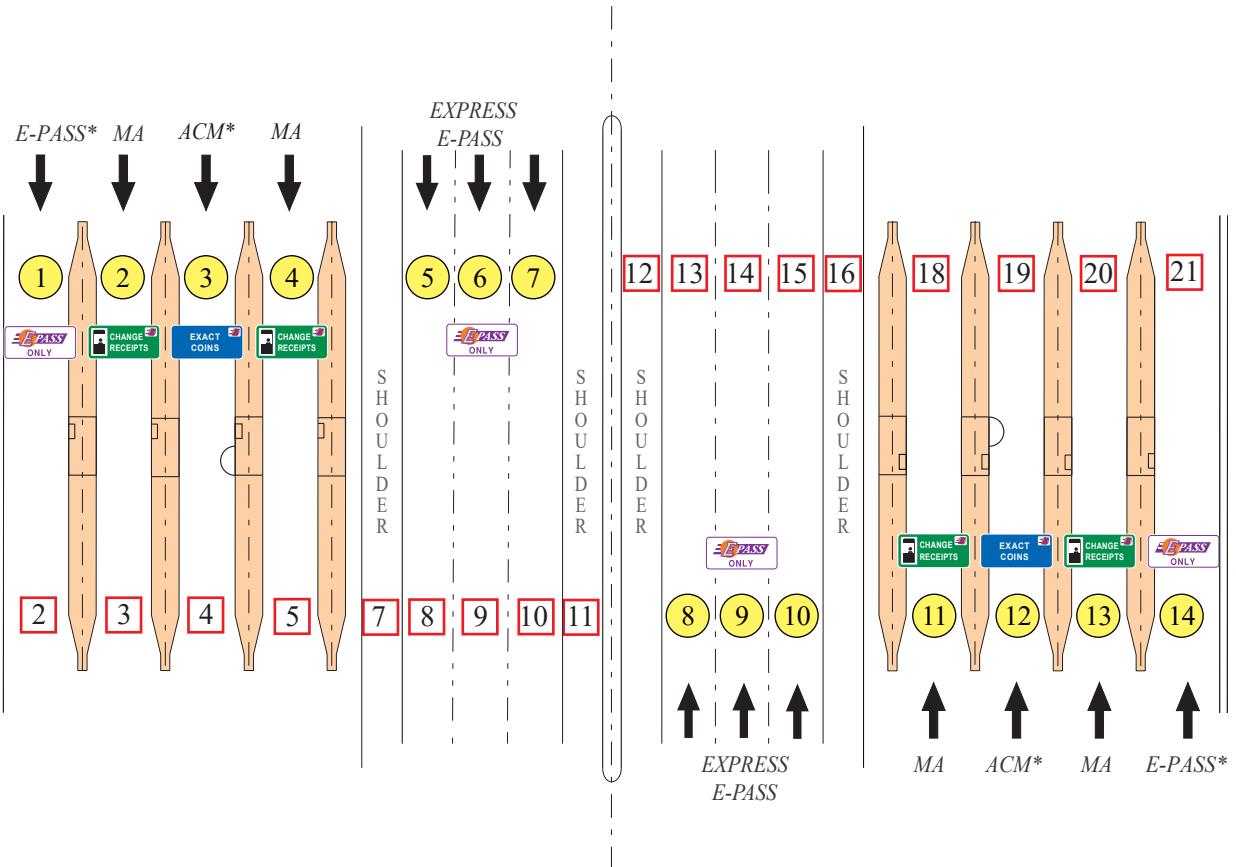

To I-4 (Downtown Orlando)

Next Interchange: John Young Pkwy. (CR 423)

Next Mainline Plaza: Conway East & West Mainline

Next Ramp Plaza: John Young Pkwy. EB-ON/
WB-OFF

Note: All Changeable Message Signs (CMS) can display three messages: EXACT COINS, CHANGE RECEIPTS, E-PASS ONLY

ORG-ID: 12	PID: 382
FACILITY: SR 408 - PINE HILLS	

LANES OF EQUIPMENT

- 4 Manned Booths with E-PASS (MA)
- 2 Booths with Automatic Coin Machines with E-PASS (ACM)
- 2 Booths with E-PASS
- 6 Express E-PASS only

* Changeable Message Sign

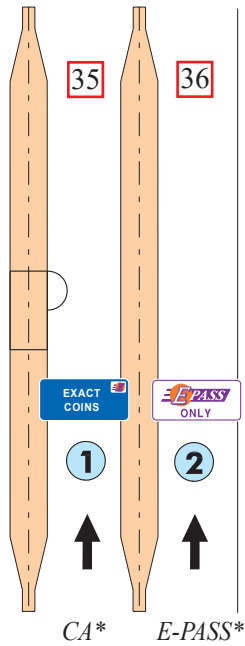
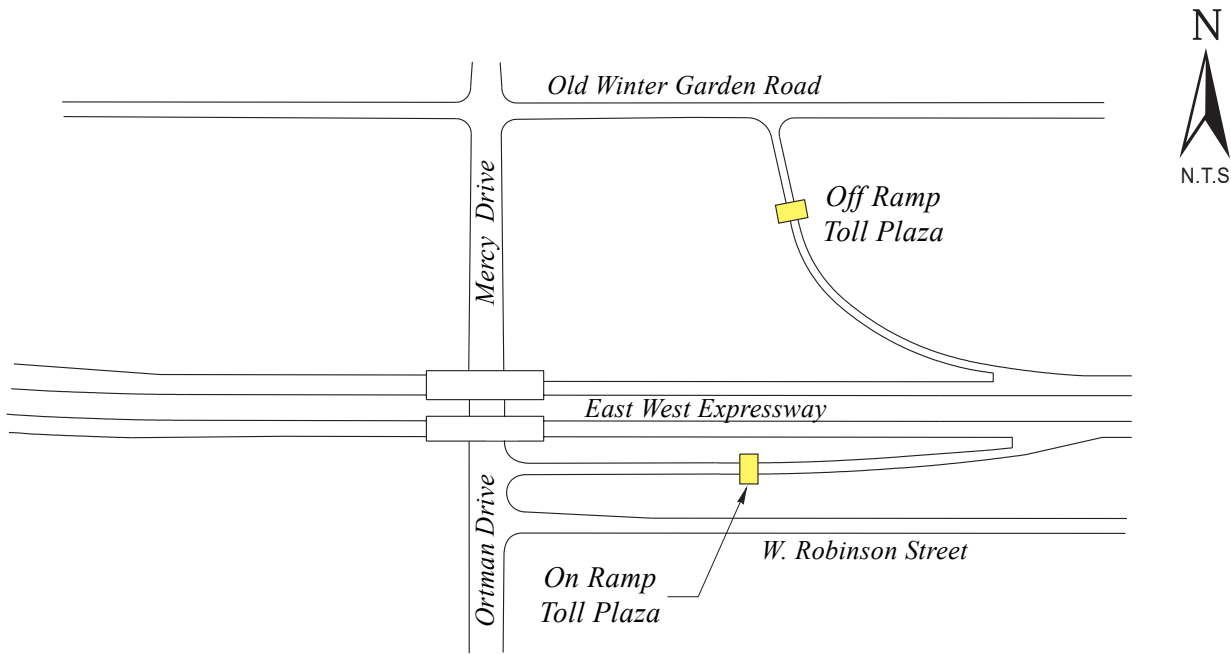

OLD WINTER GARDEN
OFF RAMP
R02
PID: 384

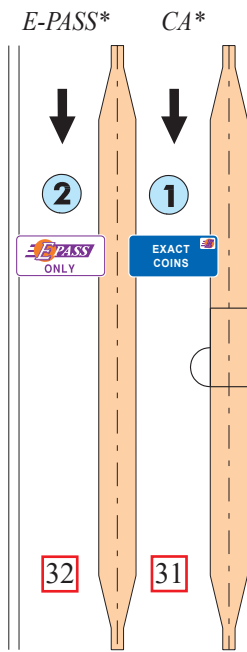

OLD WINTER GARDEN
ON RAMP
R01
PID: 383



ORG-ID: 12
FACILITY: SR 408 - PINE HILLS

* Changeable Message Sign

Note: All Changeable Message Signs (CMS) can display three messages: EXACT COINS, CHANGE RECEIPTS, E-PASS ONLY

Reports to Pine Hills Mainline Toll Plaza

T:\OCEA\OCEA MANUALS\Toll Facilities Reference Book\2016 Toll Manual - 3/10/16-CP

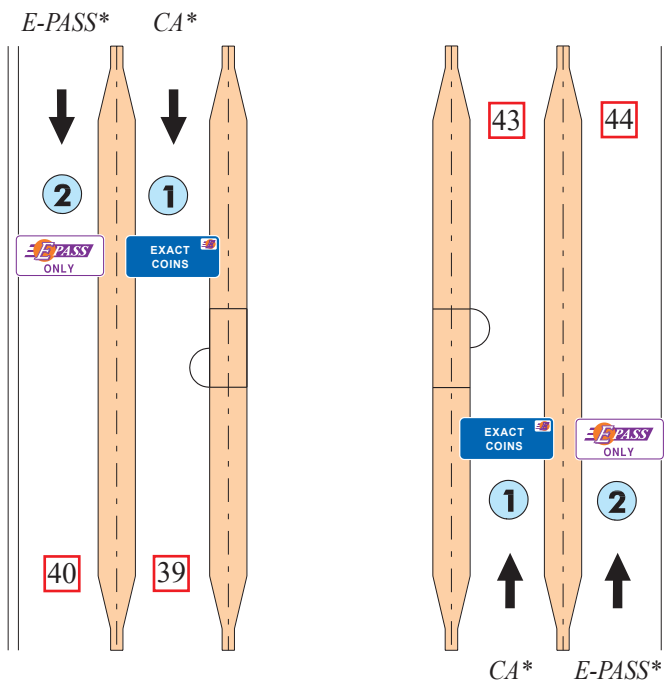
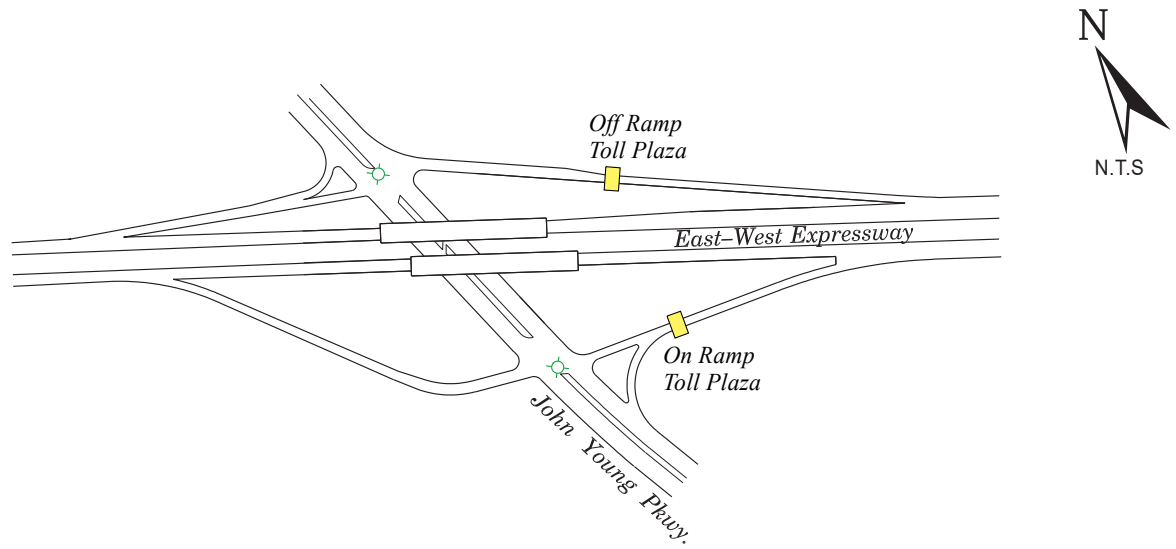

JOHN YOUNG PARKWAY
ON RAMP
R03
PID: 385

JOHN YOUNG PARKWAY
OFF RAMP
R04
PID: 386

ORG-ID: 12
FACILITY: SR 408 - PINE HILLS

* Changeable Message Sign

Note: All Changeable Message Signs (CMS) can display three messages: EXACT COINS, CHANGE RECEIPTS, E-PASS ONLY

Reports to Pine Hills Mainline Toll Plaza

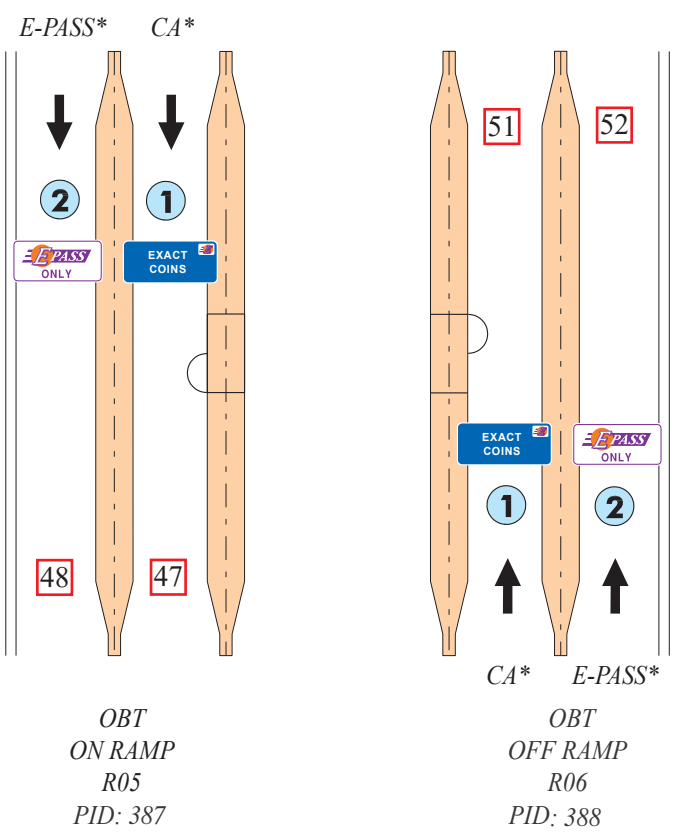
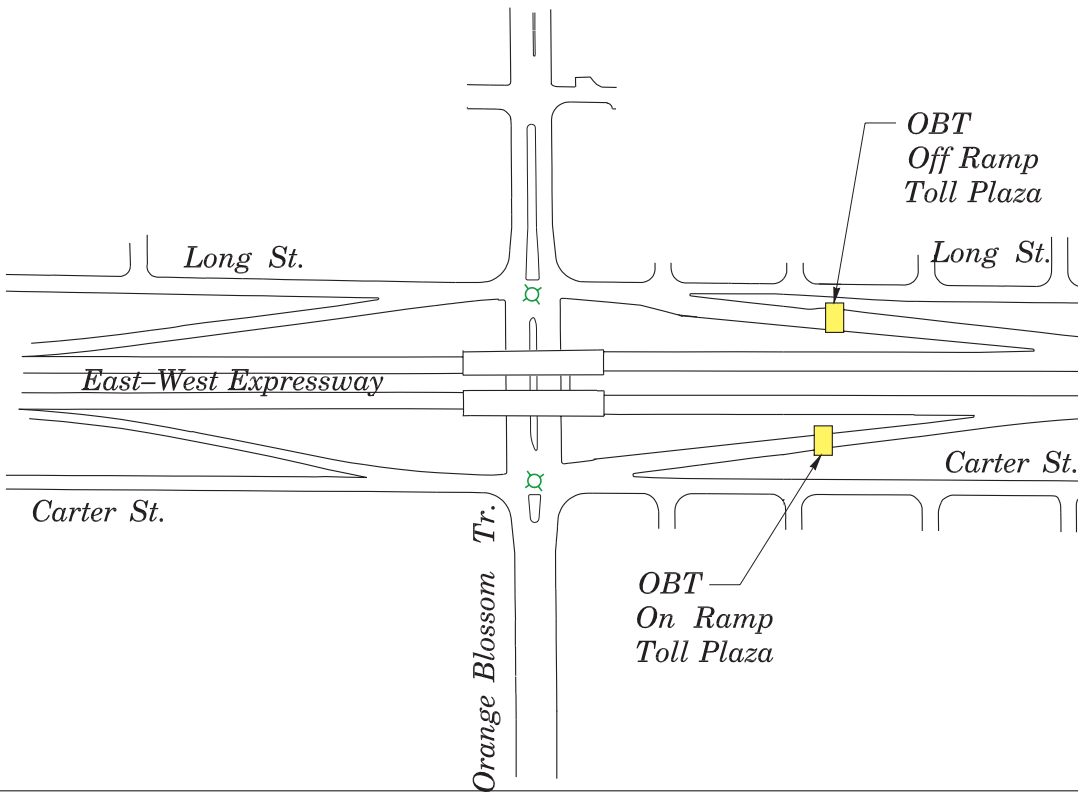

ORG-ID: 12
 FACILITY: SR 408 - PINE HILLS

* Changeable Message Sign

Note: All Changeable Message Signs (CMS) can display three messages: EXACT COINS, CHANGE RECEIPTS, E-PASS ONLY

Reports to Pines Hills Mainline Toll Plaza

T:\OCEA\OCEA MANUAL\STol Facilities Reference Book\2016 Tolls Manual - 3/10/16-CP

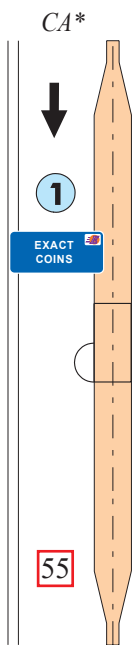
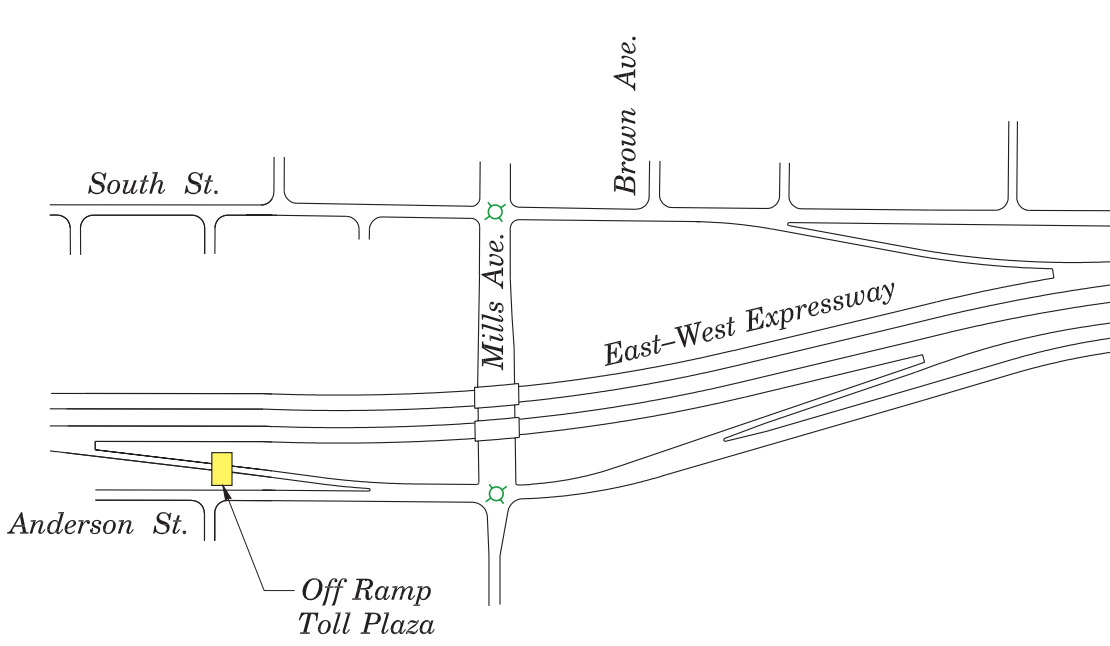

ORG-ID: 12

FACILITY: SR 408 - PINE HILLS

MILLS
OFF RAMP
R07
PID: 389

Note: All Changeable Message Signs (CMS) can display three messages: EXACT COINS, CHANGE RECEIPTS, E-PASS ONLY

Reports to Pine Hills Mainline Toll Plaza

T:\OCEA\OCEA MANUAL\STol Facilities Reference Book\2016 Tolls Manual - 3/10/16-CP



To I-4 (Downtown Orlando)

Next Interchange: Crystal Lake Dr.
Next Mainline Plaza: Pine Hills Mainline
Next Ramp Plaza: Orange Blossom Trail
WB-OFF / EB-ON

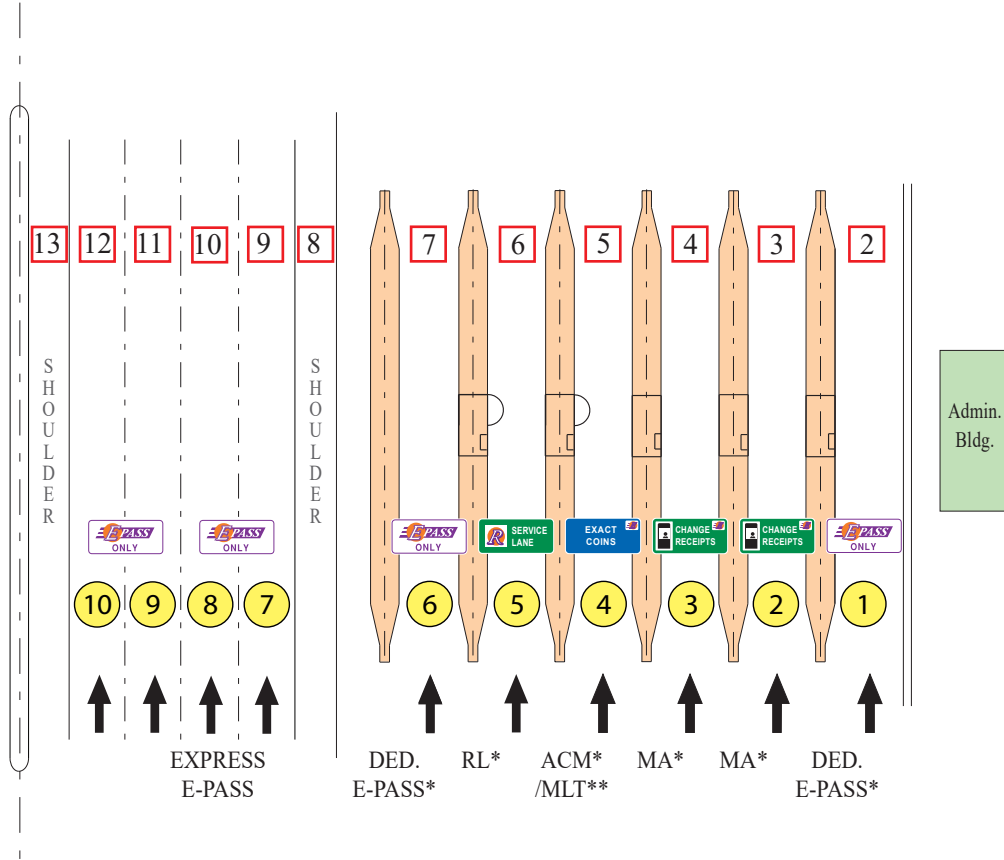

ORG-ID: 13	PID: 392
FACILITY: SR 408 - CONWAY	

LANES OF EQUIPMENT

- 2 Manned Booths with E-PASS (MA)
- 1 Booths with Automatic Coin Machines (ACM) with E-PASS
- 1 E-PASS Reload Lane (RL)
- 2 Dedicated E-PASS
- 4 Express E-PASS (E-PASS only)
- * Changeable Message Sign

** Peak Hour Operates as a Manual Booth

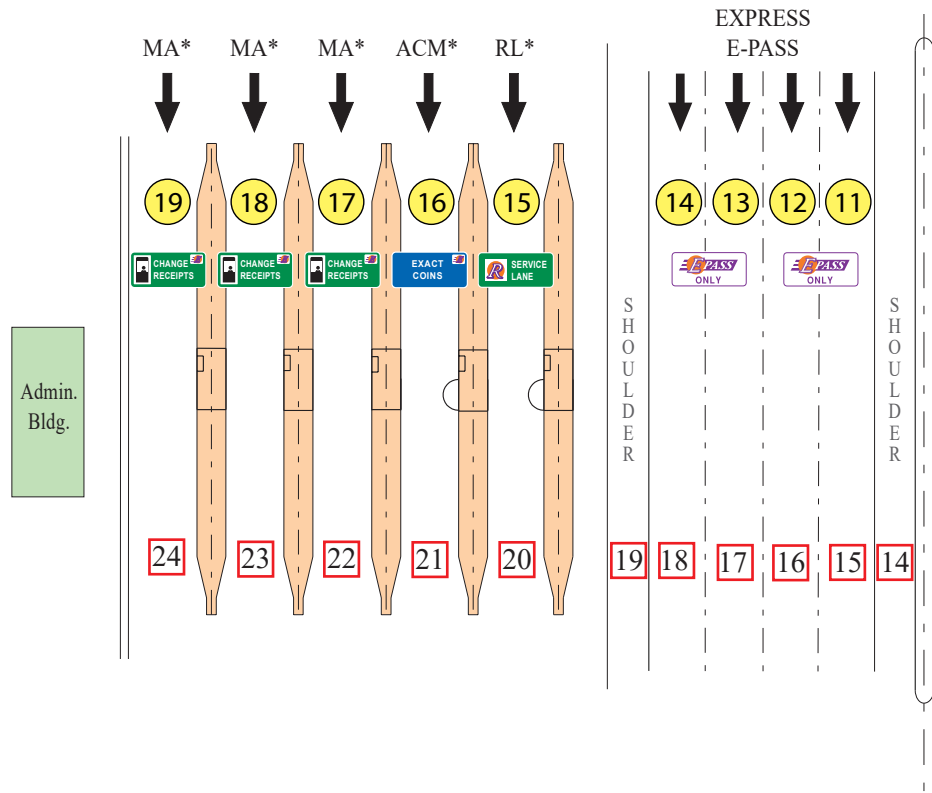

T:\OCEA\OCEA MANUAL\STol Facilities Reference Book\2016 Tolls Manual - 4/1/16-CP

↓ To SR 417 (Greene Way),

UCF & SR 50

Next Interchange: SR 551 (Goldenrod Rd.)

Next Mainline Plaza: Dean Mainline

Next Ramp Plaza: Dean Rd.

EB-OFF / WB-ON

ORG-ID: 13	PID: 392
FACILITY: SR 408 - CONWAY	

LANES OF EQUIPMENT

- 3 Manned Booths with E-PASS (MA)
- 1 Booths with Automatic Coin Machines (ACM) with E-PASS
- 1 E-PASS Reload Lane (RL)
- 4 Express E-PASS (E-PASS only)
- * Changeable Message Sign

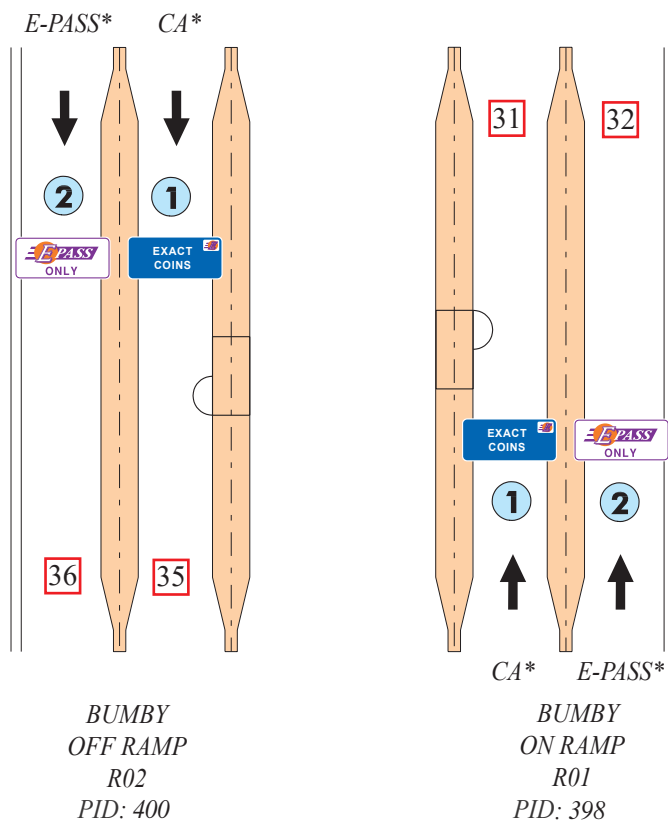
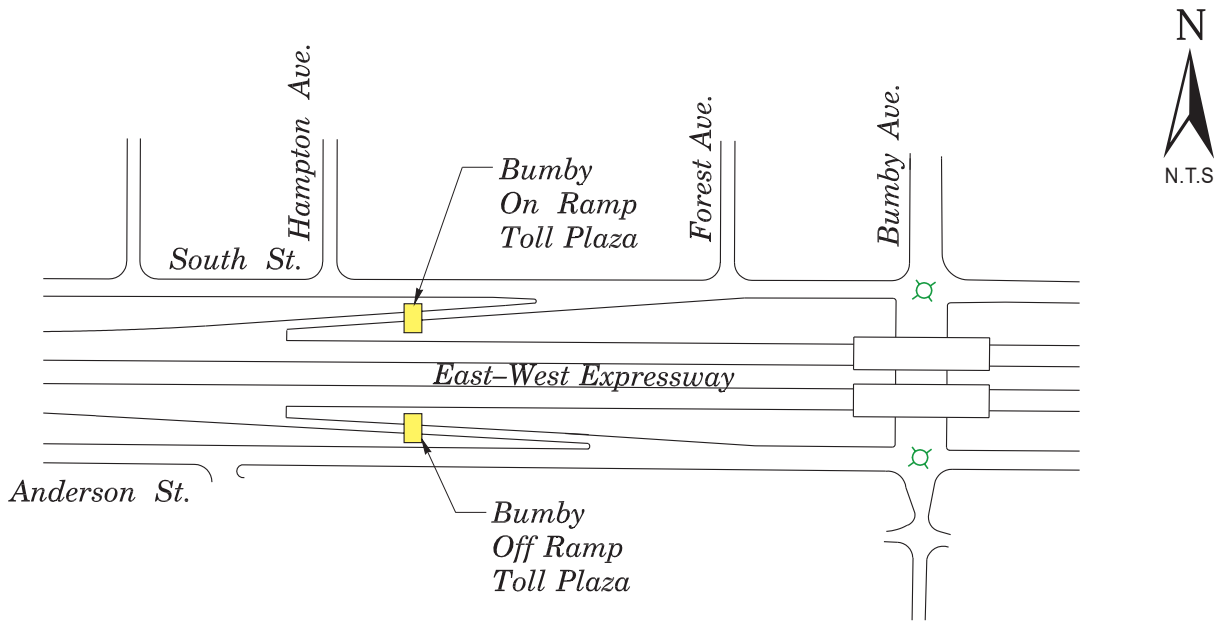

ORG-ID: 13
 FACILITY: SR 408 - CONWAY

* Changeable Message Sign

Note: All Changeable Message Signs (CMS) can display three messages: EXACT COINS, CHANGE RECEIPTS, E-PASS ONLY

Reports to Conway West Mainline Toll Plaza

T:\OCEA\OCEA MANUAL\STol Facilities Reference Book\2016 Tolls Manual - 3/10/16-CP

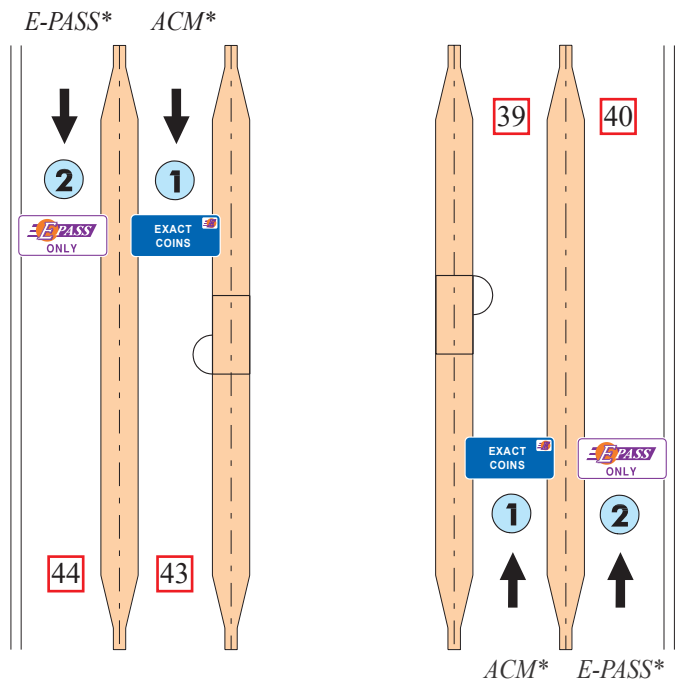
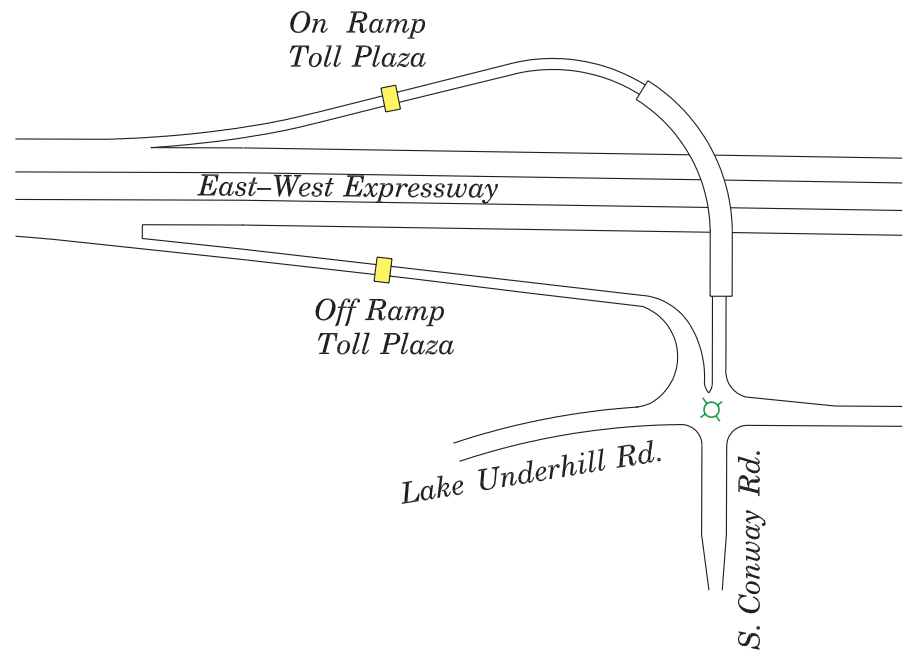

ORG-ID: 13
 FACILITY: SR 408 - CONWAY

CONWAY
 OFF RAMP
 R04
 PID: 394

CONWAY
 ON RAMP
 R03
 PID: 393

* Changeable Message Sign

Note: All Changeable Message Signs (CMS) can display three messages: EXACT COINS, CHANGE RECEIPTS, E-PASS ONLY

Reports to Conway West Mainline Toll Plaza

T:\OCEA\OCEA MANUAL\STol Facilities Reference Book\2016 Tolls Manual - 3/10/16-CP

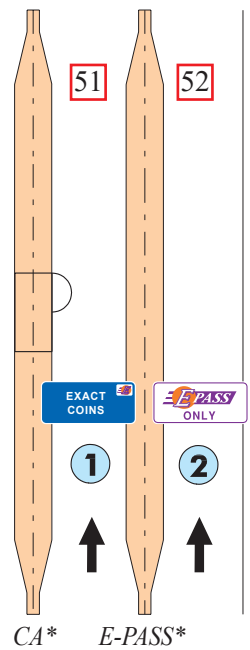
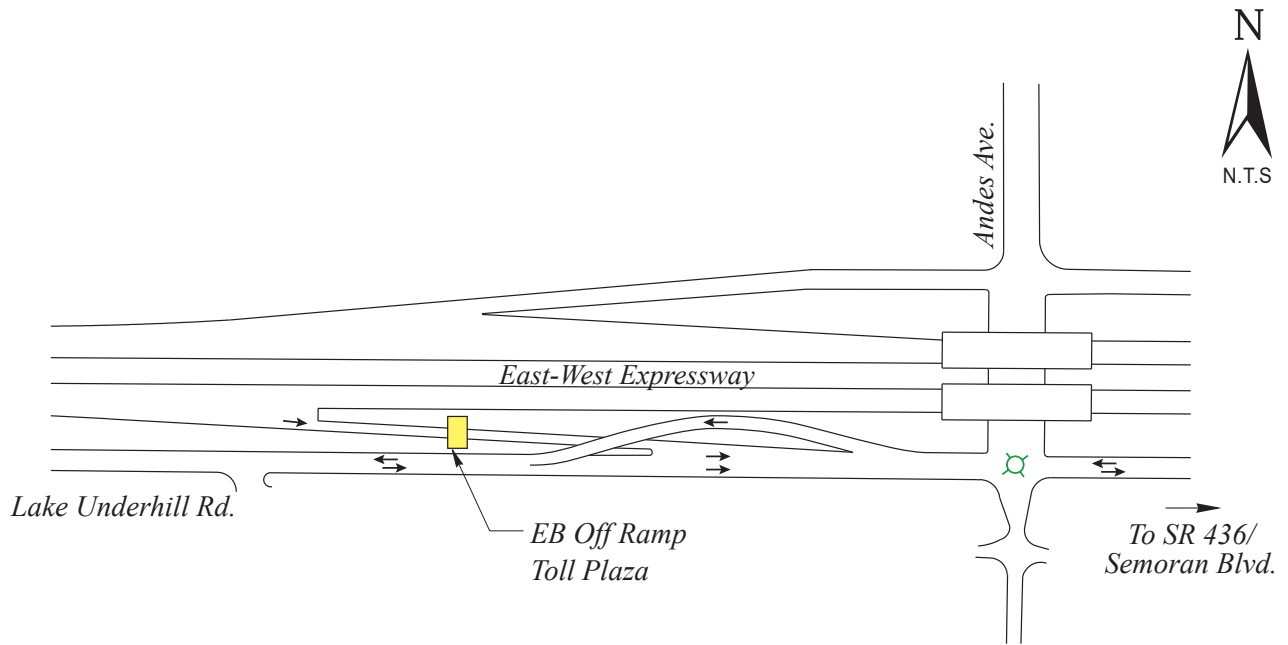

ORG-ID: 13
 FACILITY: SR 408 - CONWAY

ANDES AVE. / LAKE UNDERHILL RD.
 SR 436 / SEMORAN BLVD.
 EASTBOUND OFF RAMP
 R06
 PID: 396

Reports to Conway West Mainline Toll Plaza

* Changeable Message Sign

Note: All Changeable Message Signs (CMS) can display three messages: EXACT COINS, CHANGE RECEIPTS, E-PASS ONLY

T:\OCEA\OCEA MANUAL\STol Facilities Reference Book\2016 Tolls Manual - 3/10/16-CP

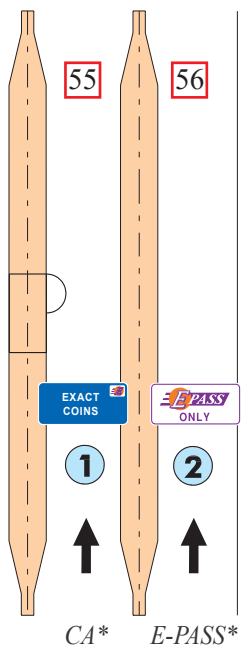
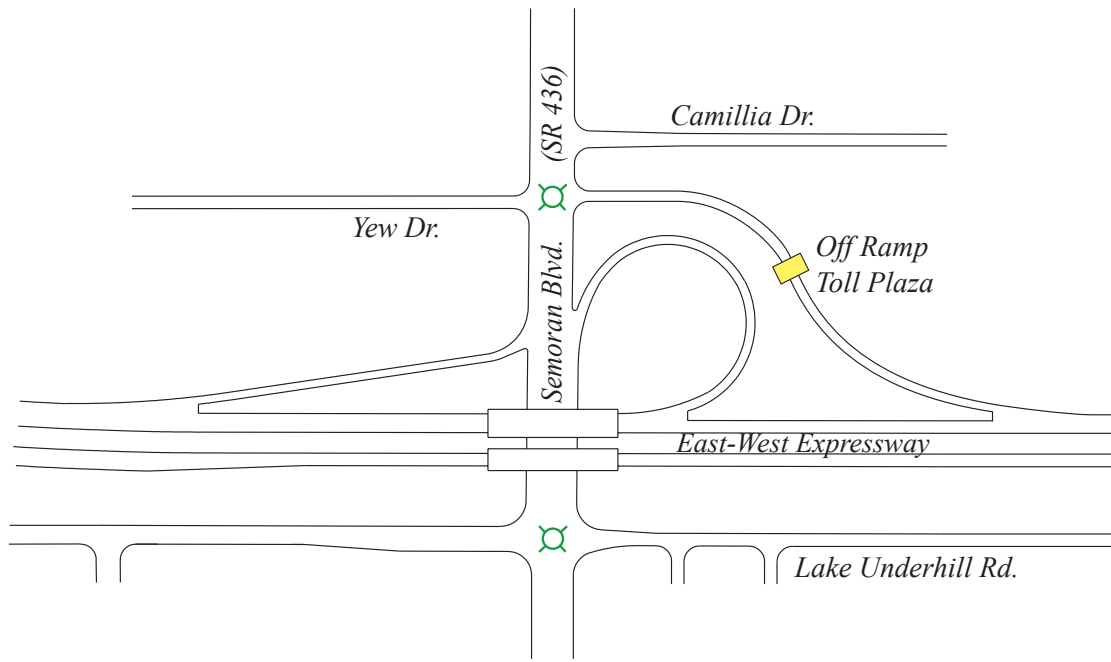

ORG-ID: 13
 FACILITY: SR 408 - CONWAY

SR 436 / SEMORAN
 WESTBOUND OFF RAMP
 R07
 PID: 395

* All Changeable Message Signs (CMS) can display three messages: EXACT COINS, CHANGE RECEIPTS, E-PASS ONLY

Reports to Conway West Mainline Toll Plaza

T:\OCEA\OCEA MANUAL\STol Facilities Reference Book\2016 Tolls Manual - 3/10/16-CP

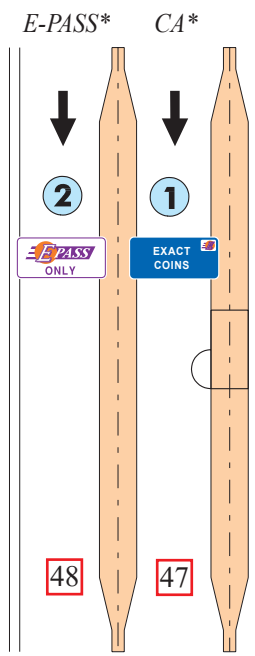
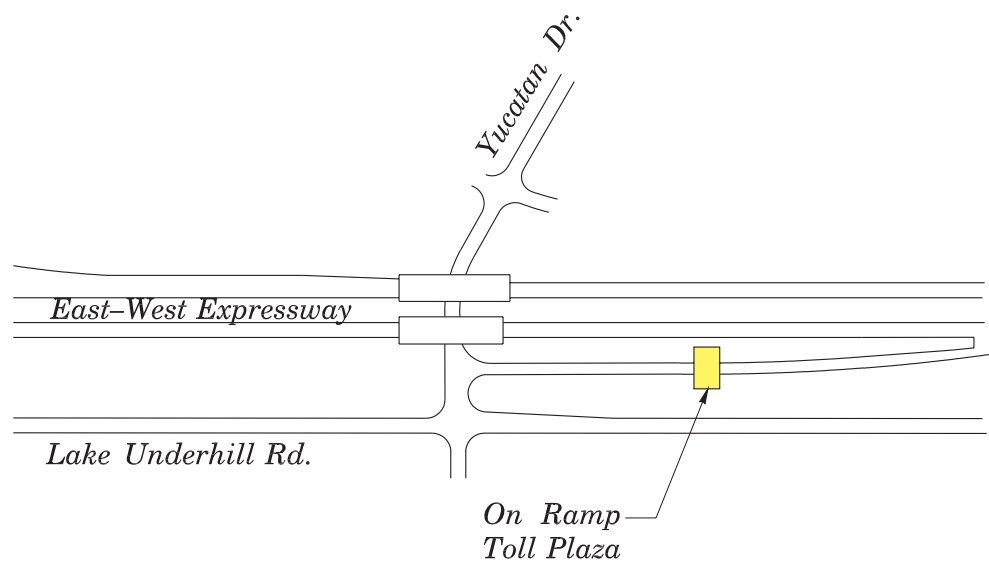

ORG-ID: 13

FACILITY: SR 408 - CONWAY

SEMORAN EAST BOUND
ON RAMP
R05
PID: 397

* All Changeable Message Signs (CMS) can display three messages: EXACT COINS, CHANGE RECEIPTS, E-PASS ONLY

Reports to Conway West Mainline Toll Plaza

T:\OCEA\OCEA MANUAL\STol Facilities Reference Book\2016 Tolls Manual - 3/10/16-CP



To SR 417 (GreeneWay) &
Downtown Orlando
Next Interchange: Dean Rd.
Next Mainline Plaza: Conway
East & West Mainline
Next Ramp Plaza: Dean
EB-ON/WB-OFF



To SR 50, UCF & Titusville
Next Interchange: Rouse Rd.
Next Mainline Plaza: None
Next Ramp Plaza: Rouse
EB-ON/WB-OFF

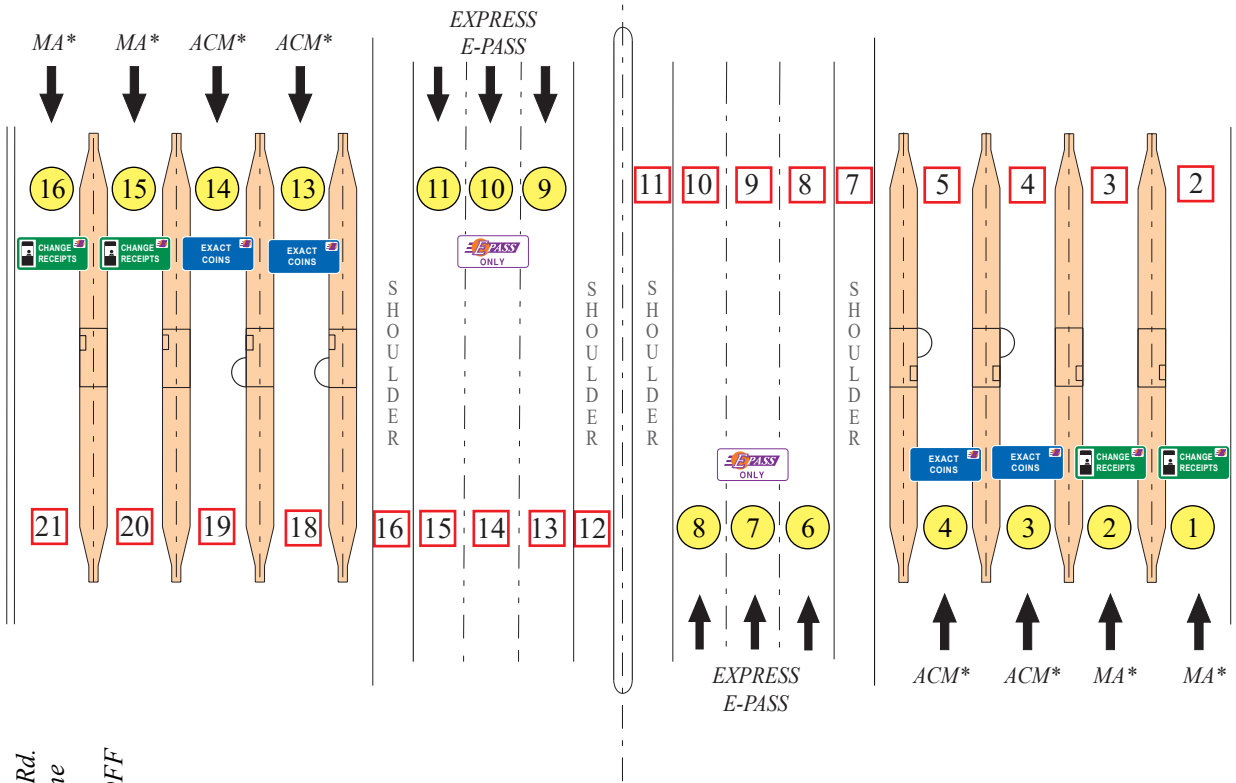

Note: All Changeable Message Signs (CMS) can display three messages: EXACT COINS, CHANGE RECEIPTS, E-PASS ONLY

ORG-ID: 4	PID: 315
FACILITY: SR 408 - DEAN	

- LANES OF EQUIPMENT
- 6 Express E-PASS (E-PASS only)
 - 4 Booths with Automatic Coin Machines with E-PASS (ACM)
 - 4 Manned Booths with E-PASS (MA)
 - * Changeable Message Sign

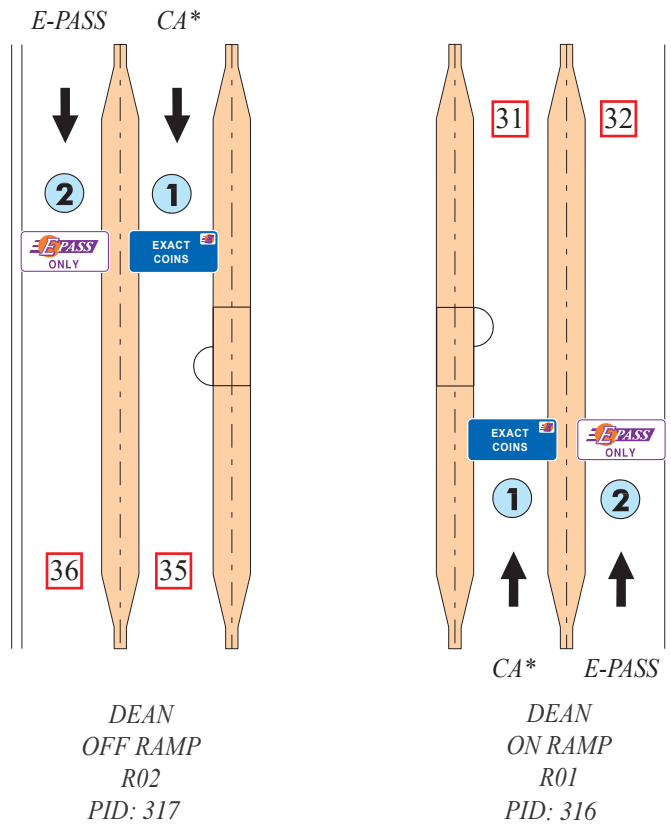
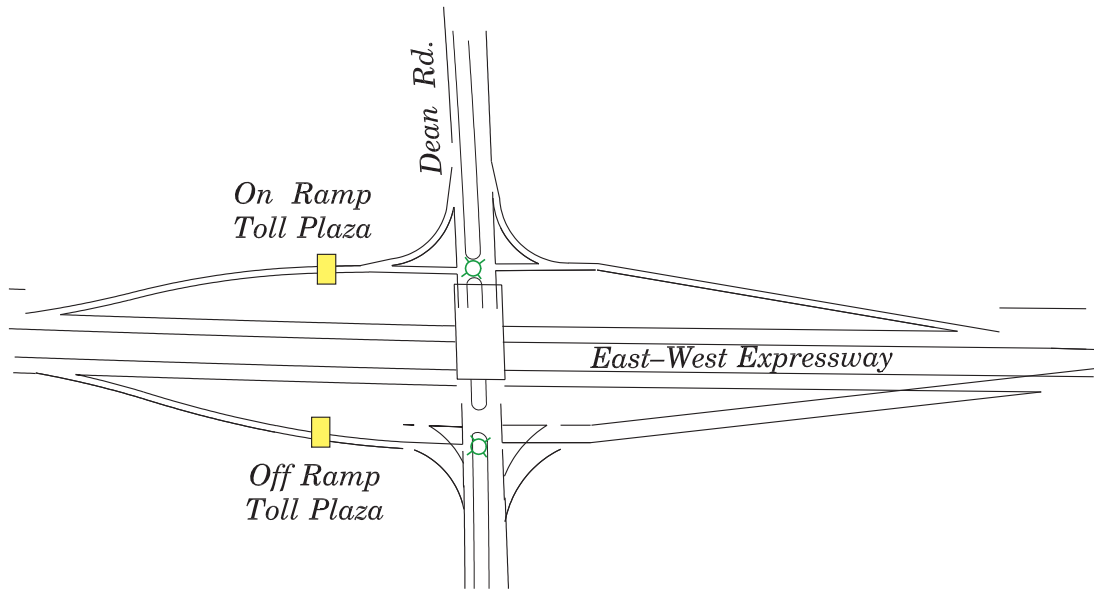

ORG-ID: 4
 FACILITY: SR 408 - DEAN

* Changeable Message Sign

Note: All Changeable Message Signs (CMS) can display three messages: EXACT COINS, CHANGE RECEIPTS, E-PASS ONLY

Reports to Dean Mainline Toll Plaza

T:\OCEA\OCEA MANUAL\STol Facilities Reference Book\2016 Tolls Manual - 3/10/16-CP

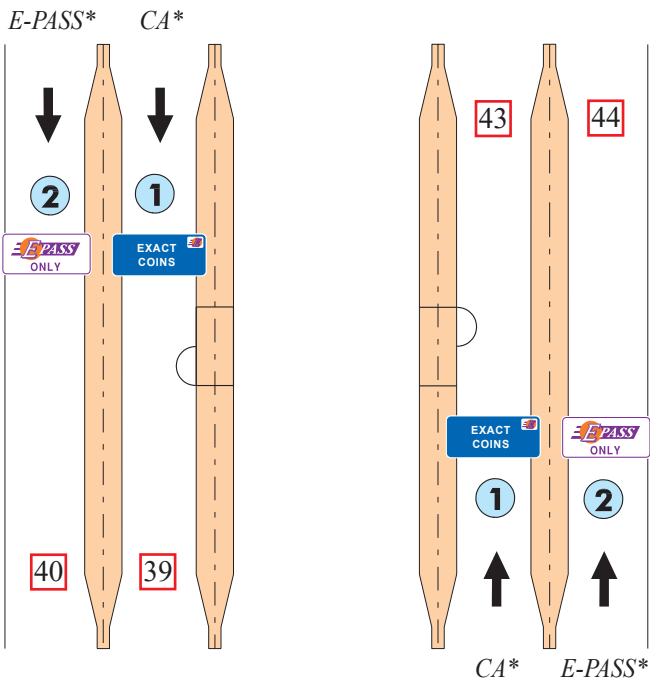
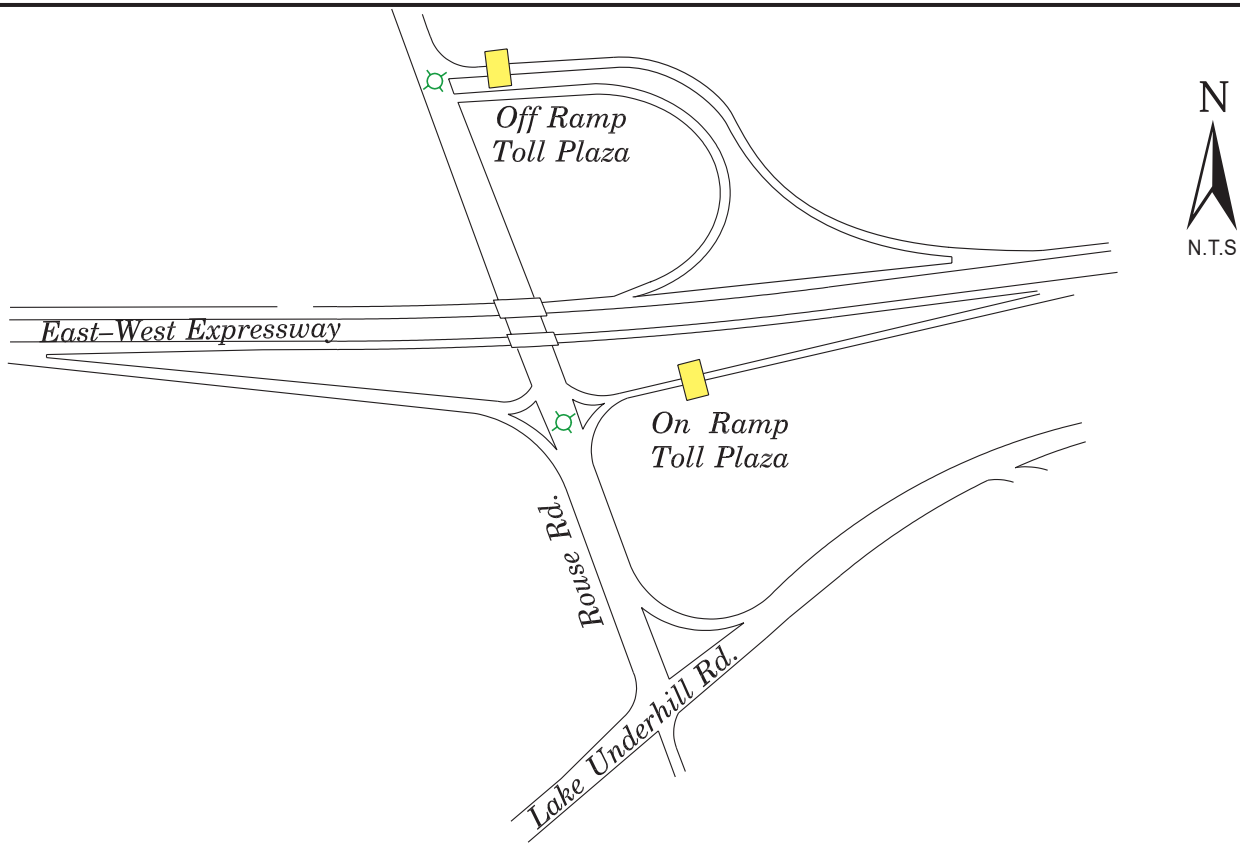

ORG-ID: 4
 FACILITY: SR 408 - DEAN

* Changeable Message Sign

Note: All Changeable Message Signs (CMS) can display three messages: EXACT COINS, CHANGE RECEIPTS, E-PASS ONLY

Reports to Dean Mainline Toll Plaza

T:\OCEA\OCEA MANUAL\STol Facilities Reference Book\2016 Tolls Manual - 3/10/16-CP

John Land Apopka Expressway



Mainline Toll Plaza and Associated Tolloed Ramps

LEGEND

For Lane Designations for all Plazas

CA - Exact Coin with E-PASS

MA - Change Receipts (Manned) with E-PASS

*ACM - Booth with Manual Lane Terminal,
Automatic Coin Machine and E-PASS*



To SR 429, Apopka

Next Interchange: SR 429

Next Mainline Plaza: None

Next Ramp Plaza: None

To US 441, I-4, Maitland, US 17/92

Next Interchange: Hiwassee Rd.

Next Mainline Plaza: None

Next Ramp Plaza: Hiwassee Rd.
EB-ON/WB-OFF

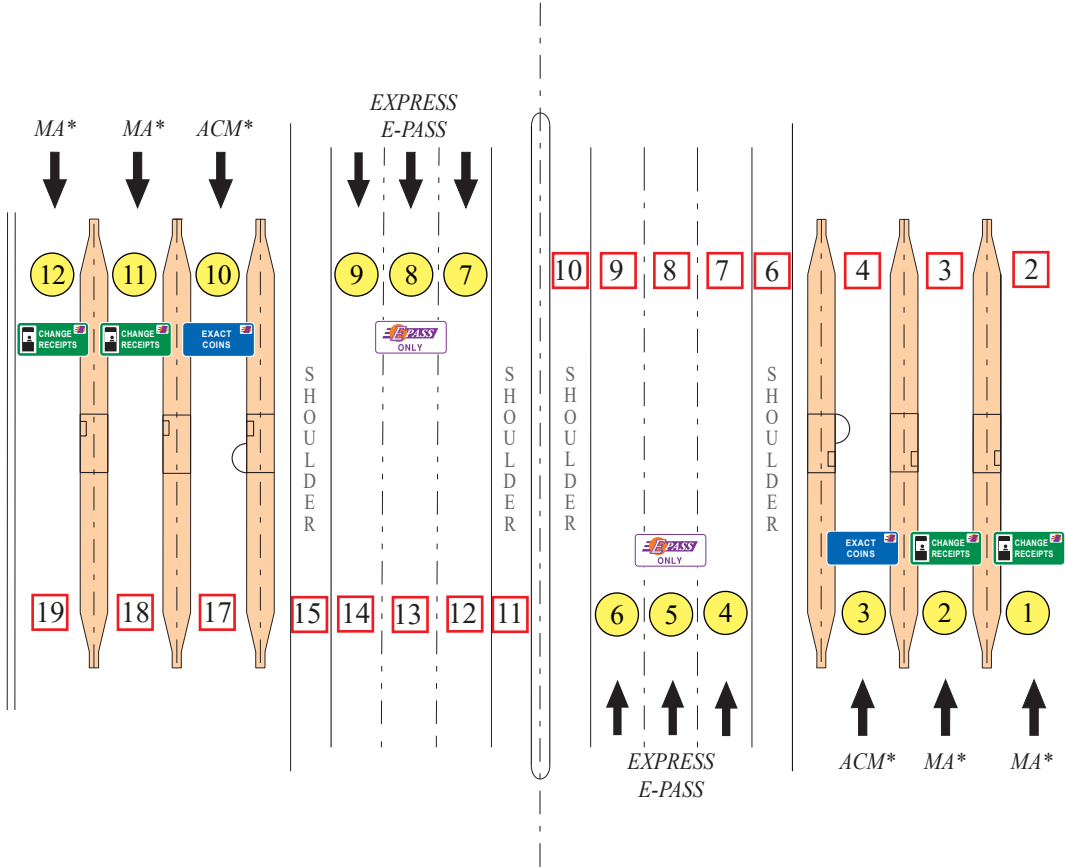

Note: All Changeable Message Signs (CMS) can display three messages: EXACT COINS, CHANGE RECEIPTS, E-PASS ONLY

ORG-ID: 14	PID: 401
FACILITY: SR 414 - CORAL HILLS	

LANES OF EQUIPMENT

- 4 Manned Booths with E-PASS (MA)
- 2 Booths with ACM's and E-PASS
- 6 Express E-PASS (E-PASS only)
- * Changeable Message Sign

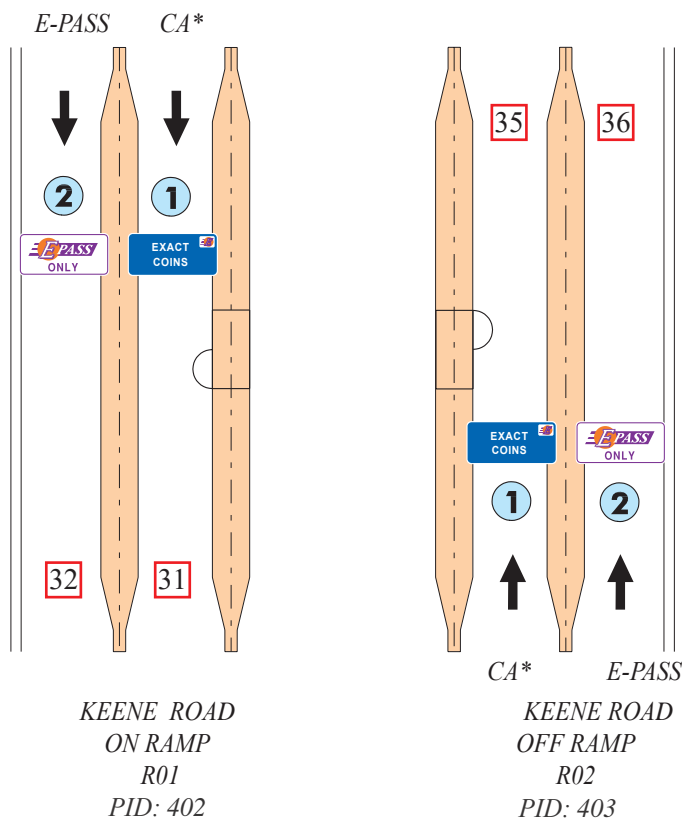
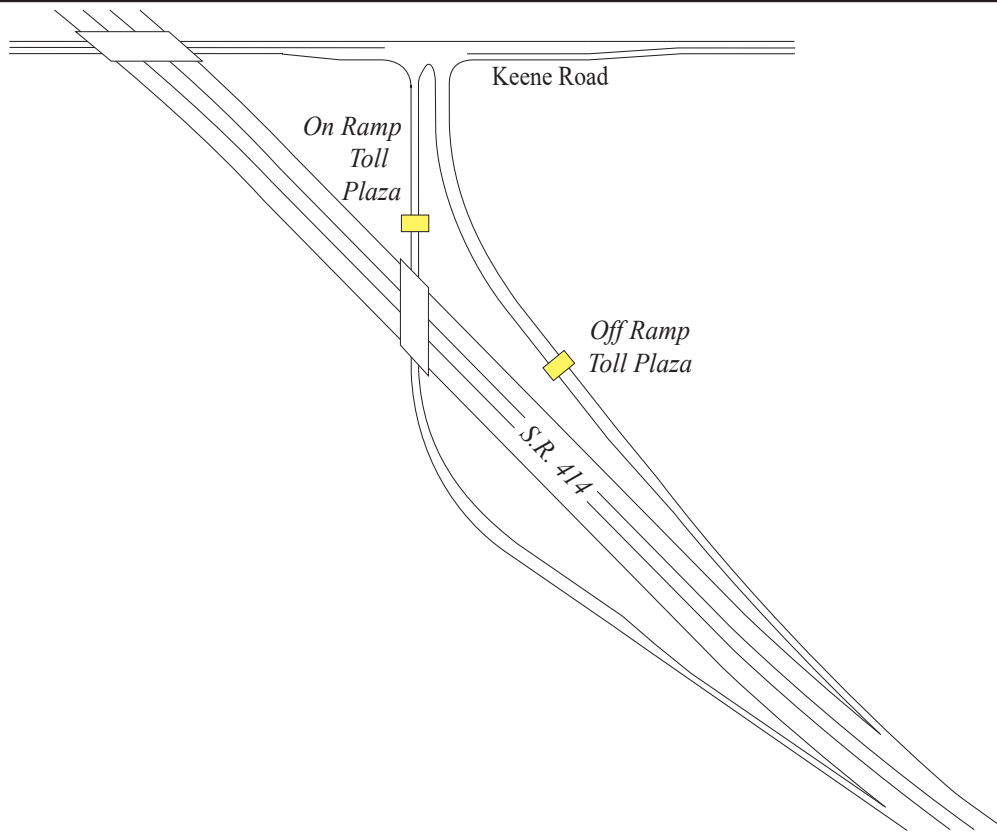

ORG-ID: 14
 FACILITY: SR 414 - CORAL HILLS

* Changeable Message Sign

Note: All Changeable Message Signs (CMS) can display three messages: EXACT COINS, CHANGE RECEIPTS, E-PASS ONLY

Reports to Coral Hills Mainline Toll Plaza

T:\OCEA\OCEA MANUAL\STol Facilities Reference Book\2016 Tolls Manual - 3/10/16-CP

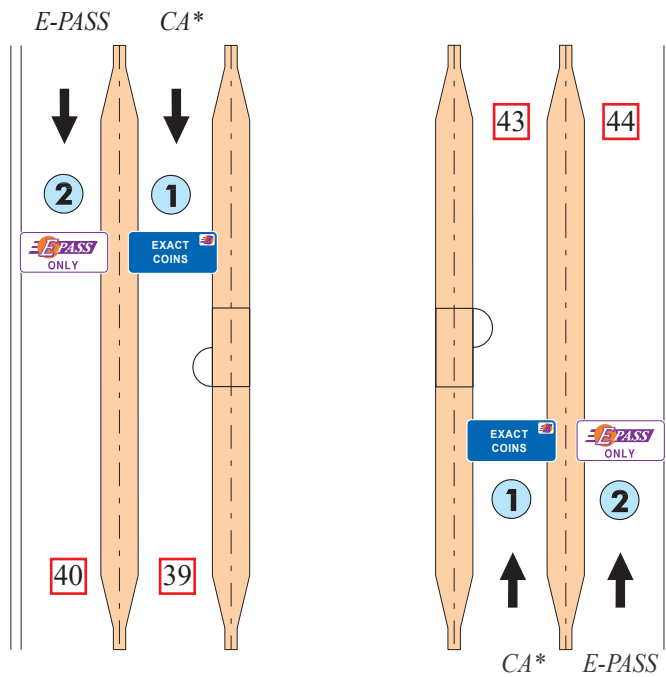
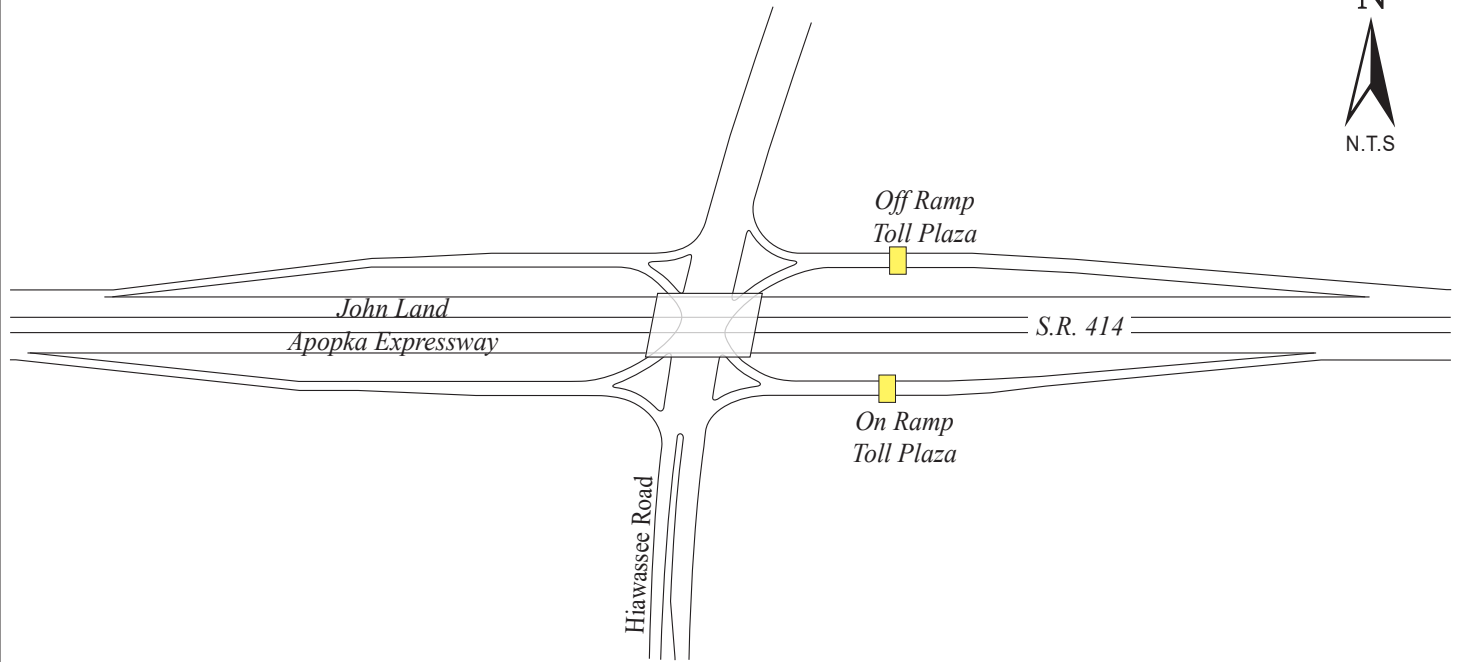

ORG-ID: 14
 FACILITY: SR 414 - CORAL HILLS

* Changeable Message Sign

HIWASSEE 414
 ON RAMP
 R03
 PID: 404

HIWASSEE 414
 OFF RAMP
 R04
 PID: 405

Note: All Changeable Message Signs (CMS) can display three messages: EXACT COINS, CHANGE RECEIPTS, E-PASS ONLY

Reports to Coral Hills Mainline Toll Plaza

T:\OCEA\OCEA MANUALS\Toll Facilities Reference Book\2016 Tolls Manual - 3/10/16-CP

Central Florida GreeneWay

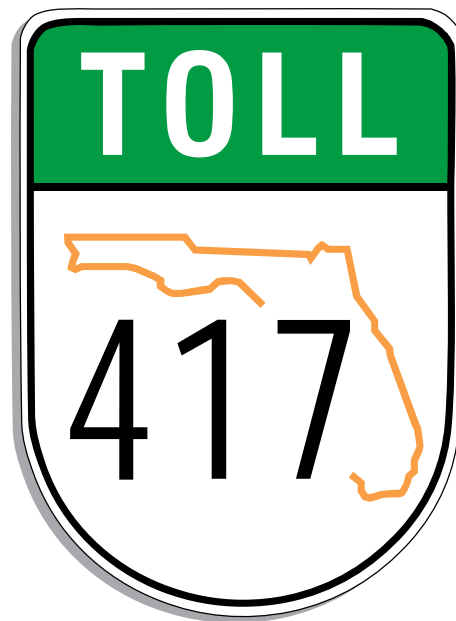

Mainline Toll Plazas and Associated Tolloed Ramps

LEGEND

For Lane Designations for all Plazas

CA - Exact Coin with E-PASS

MA - Change Receipts (Manned) with E-PASS

*ACM - Booth with Manual Lane Terminal,
Automatic Coin Machine and E-PASS*



To Orlando Int'l Airport,
SR 528 (Beachline), Sanford

Next Interchange: John Young Pkwy.
Next Mainline Plaza: Boggy Creek Mainline
Next Ramp Plaza: John Young Pkwy.
EB-ON/WB-OFF

To International Drive &
I-4 (Walt Disney World)

Next Interchange: International Drive
Next Mainline Plaza: Celebration Mainline
(Turnpike)
Next Ramp Plaza: Osceola Parkway (Turnpike)
EB-OFF/WB-ON

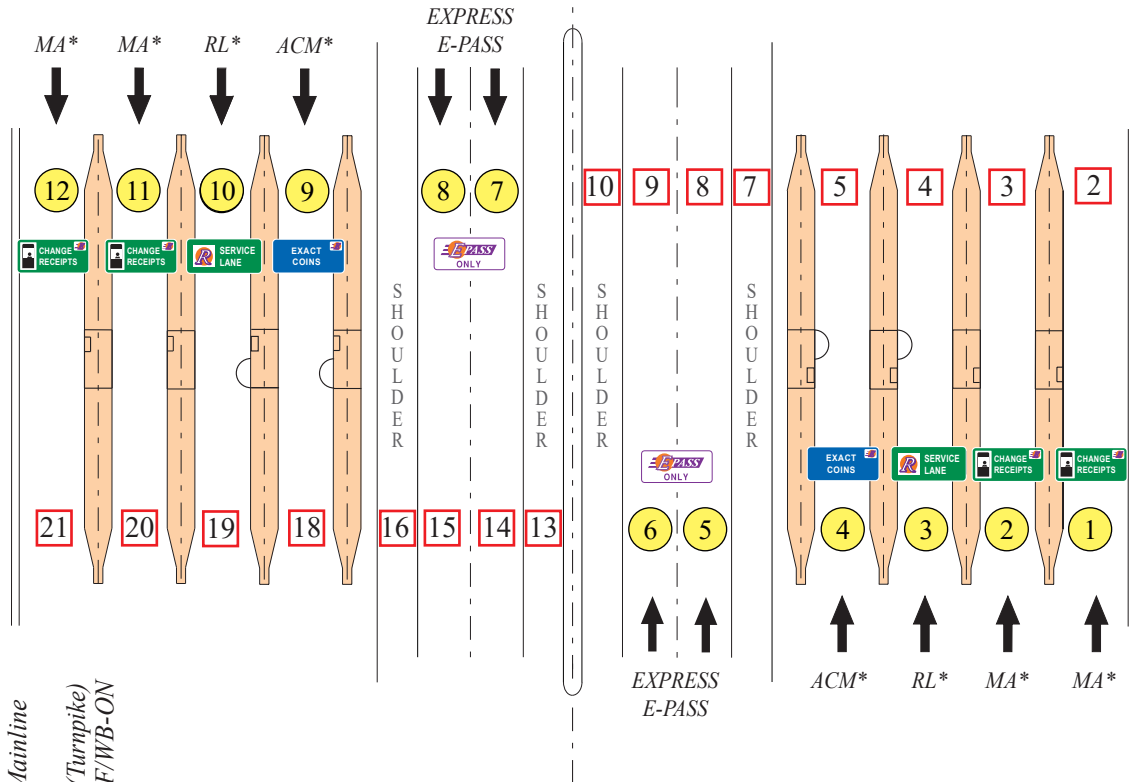

ORG-ID: 7	PID: 331
FACILITY: SR 417 - JOHN YOUNG	

LANES OF EQUIPMENT

- 4 Manned Booths with E-PASS (MA)
- 2 Booths with Automatic Coin Machines (ACM) with E-PASS
- 2 E-PASS Reload Lane (RL)
- 4 Express E-PASS (E-PASS only)
- * Changeable Message Sign

Note: All Changeable Message Signs (CMS) can display three messages: EXACT COINS, CHANGE RECEIPTS, E-PASS ONLY

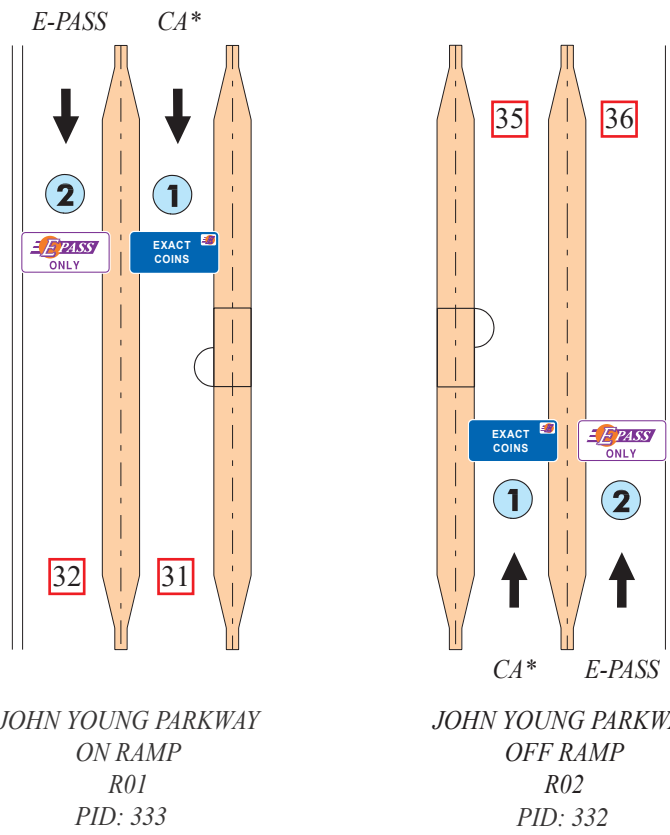
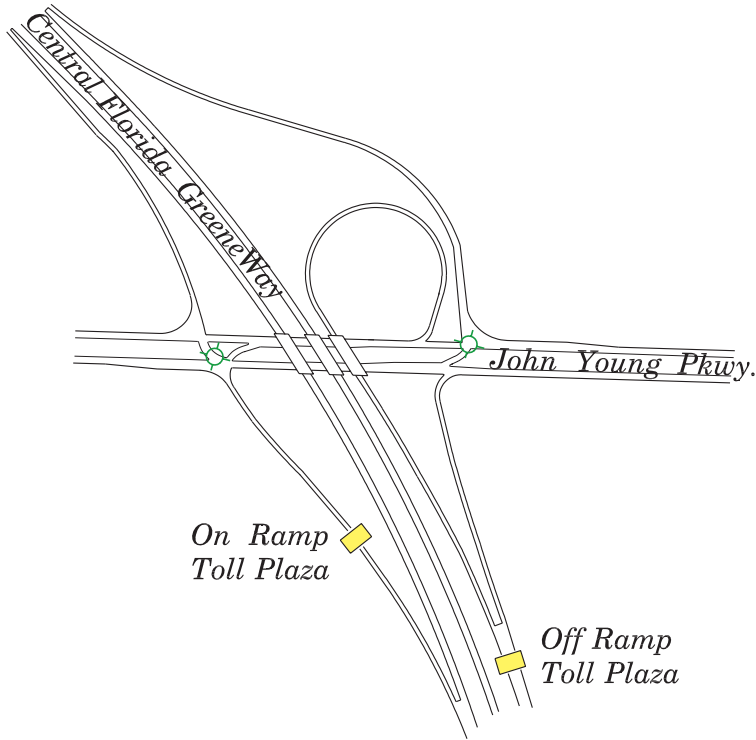

ORG-ID: 7
 FACILITY: SR 417 - JOHN YOUNG

* Changeable Message Sign

Note: All Changeable Message Signs (CMS) can display three messages: EXACT COINS, CHANGE RECEIPTS, E-PASS ONLY

Reports to John Young Mainline Toll Plaza

T:\OCEA\OCEA MANUAL\STol Facilities Reference Book\2016 Tolls Manual - 3/10/16-CP

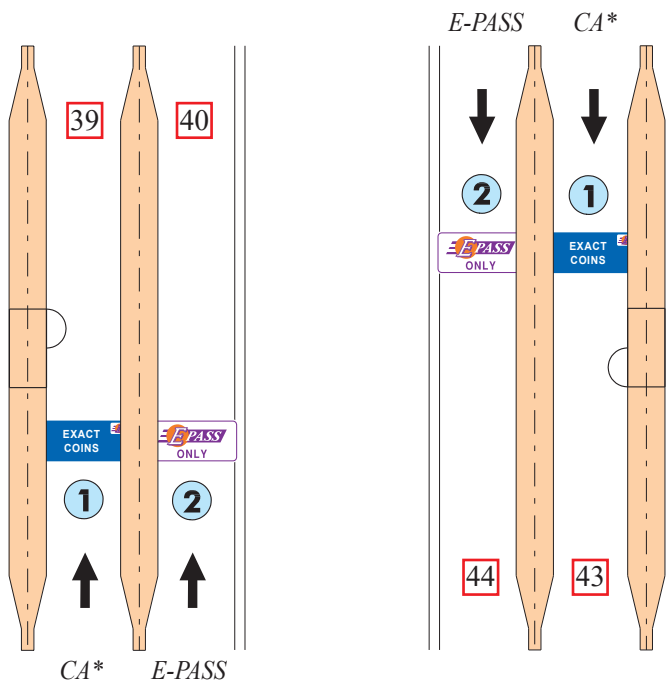
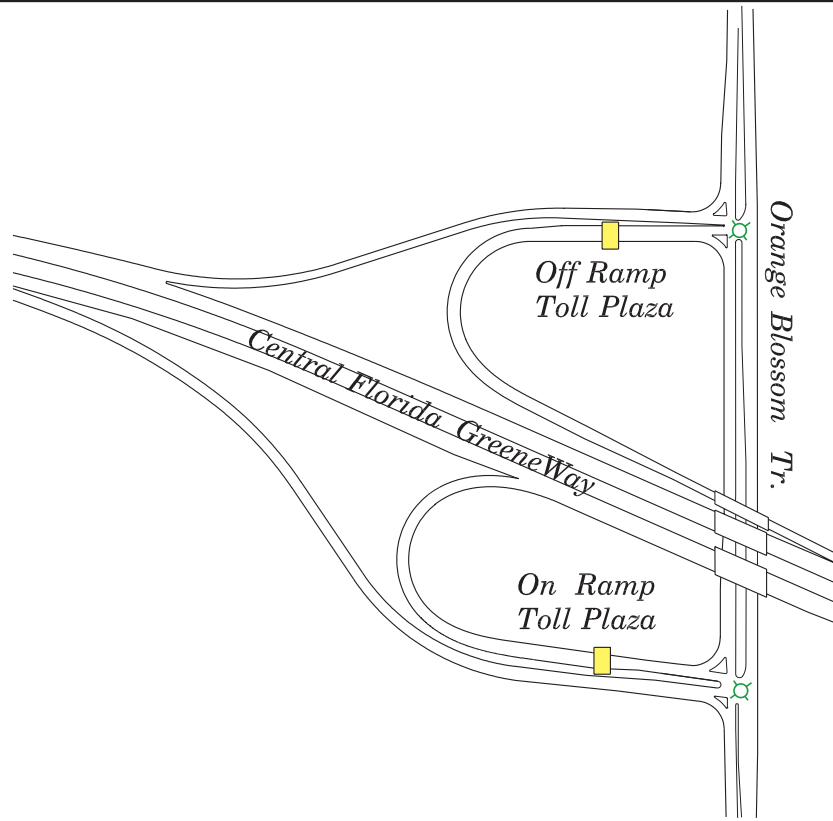

ORG-ID: 7
 FACILITY: SR 417 - JOHN YOUNG

* Changeable Message Sign

OBT
 ON RAMP
 R03
 PID: 335

OBT
 OFF RAMP
 R04
 PID: 334

Note: All Changeable Message Signs (CMS) can display three messages: EXACT COINS, CHANGE RECEIPTS, E-PASS ONLY

Reports to John Young Mainline Toll Plaza

T:\DOCEA\DOCEA MANUAL\STol Facilities Reference Book\2016 Tolls Manual - 3/10/16-CP

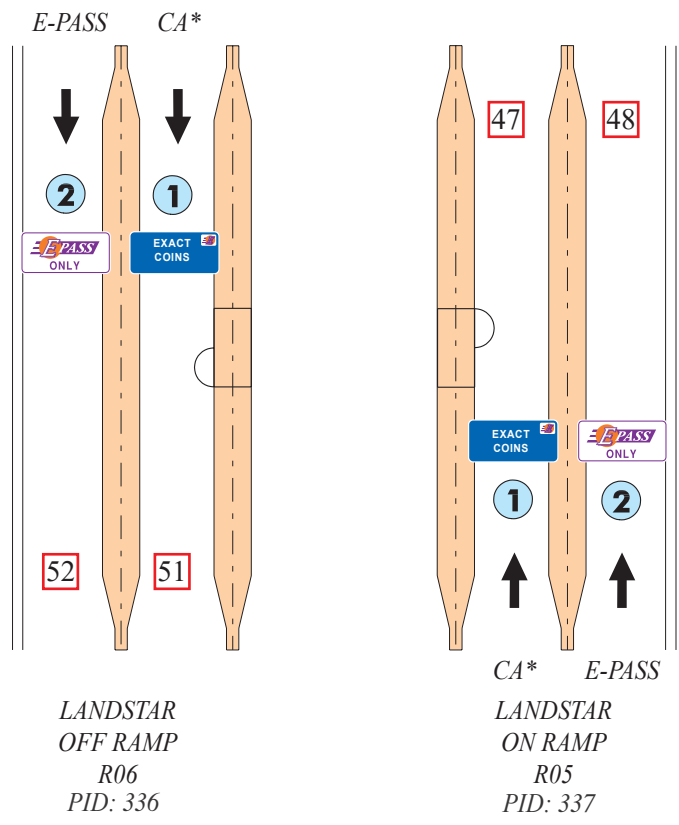
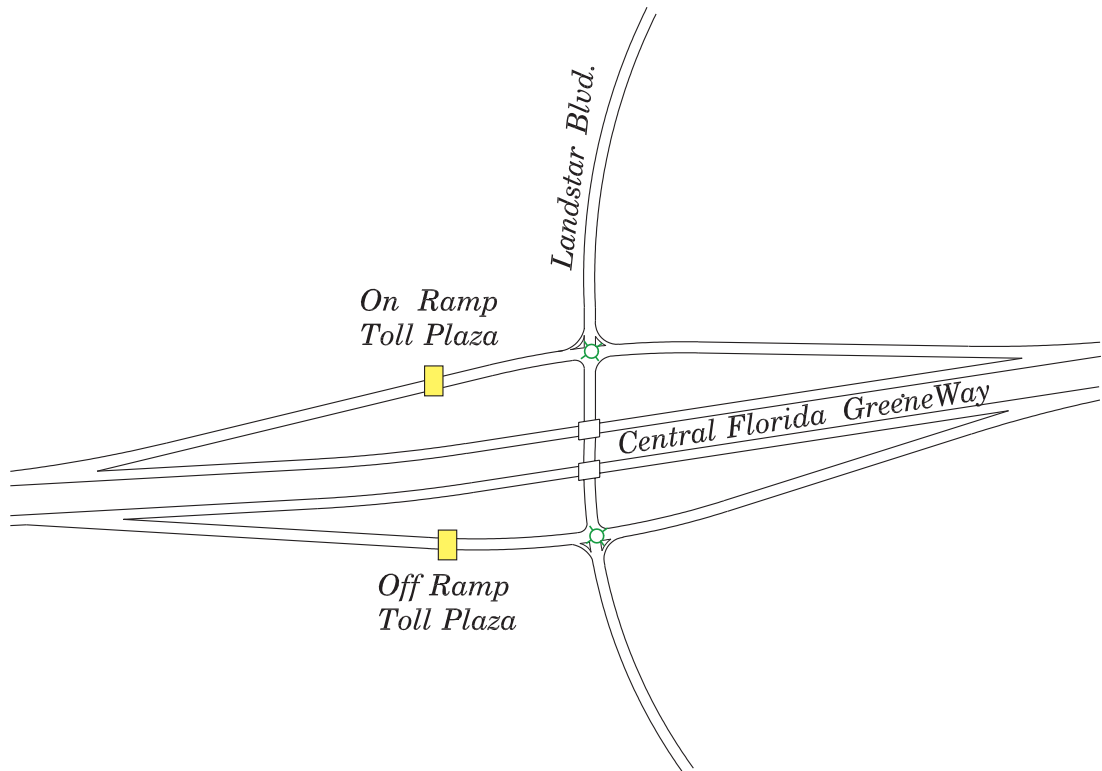

ORG-ID: 7
 FACILITY: SR 417 - JOHN YOUNG

Note: All Changeable Message Signs (CMS) can display three messages: EXACT COINS, CHANGE RECEIPTS, E-PASS ONLY

Reports to John Young Mainline Toll Plaza

T:\OCEA\OCEA MANUAL\STol Facilities Reference Book\2016 Tolls Manual - 3/10/16-CP



To Orlando Int'l. Airport,
SR 528 (Beachline), Sanford

Next Interchange: Bogy Creek Rd.
Next Mainline Plaza: Curry Ford Mainline
Next Ramp Plaza: Bogy Creek
EB-ON/WB-OFF

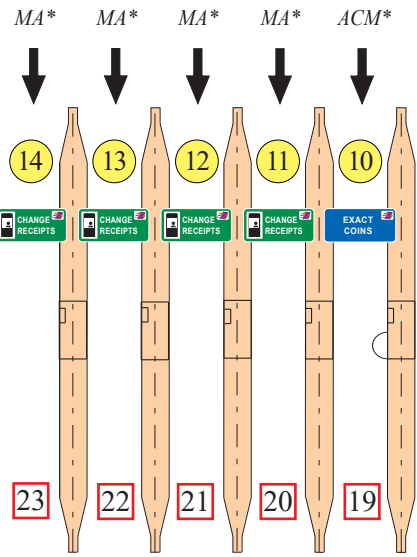

EXPRESS
E-PASS

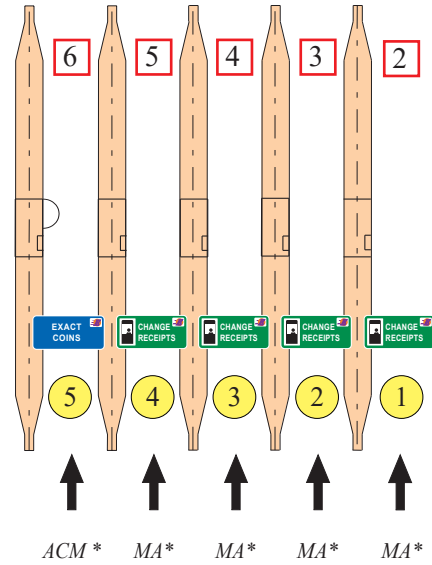
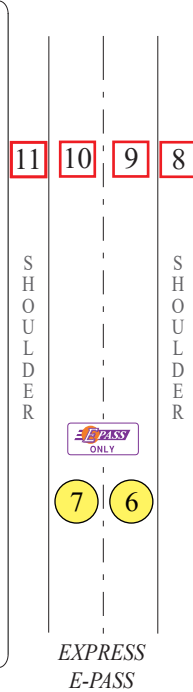

Admin.
Bldg.

To International Drive & I-4
(Walt Disney World Area)

Next Interchange: Landstar Blvd.
Next Mainline Plaza: John Young Mainline
Next Ramp Plaza: Landstar
WB-ON/EB-OFF



Note: All Changeable Message Signs (CMS) can display three messages: EXACT COINS, CHANGE RECEIPTS, E-PASS ONLY

ORG-ID: 8 PID: 338
FACILITY: SR 417 - BOGGY CREEK

LANES OF EQUIPMENT

- 8 Manned Booths with E-PASS (MA)
- 2 ACM with E-PASS
- 4 Express E-PASS
- * Changeable Message Sign

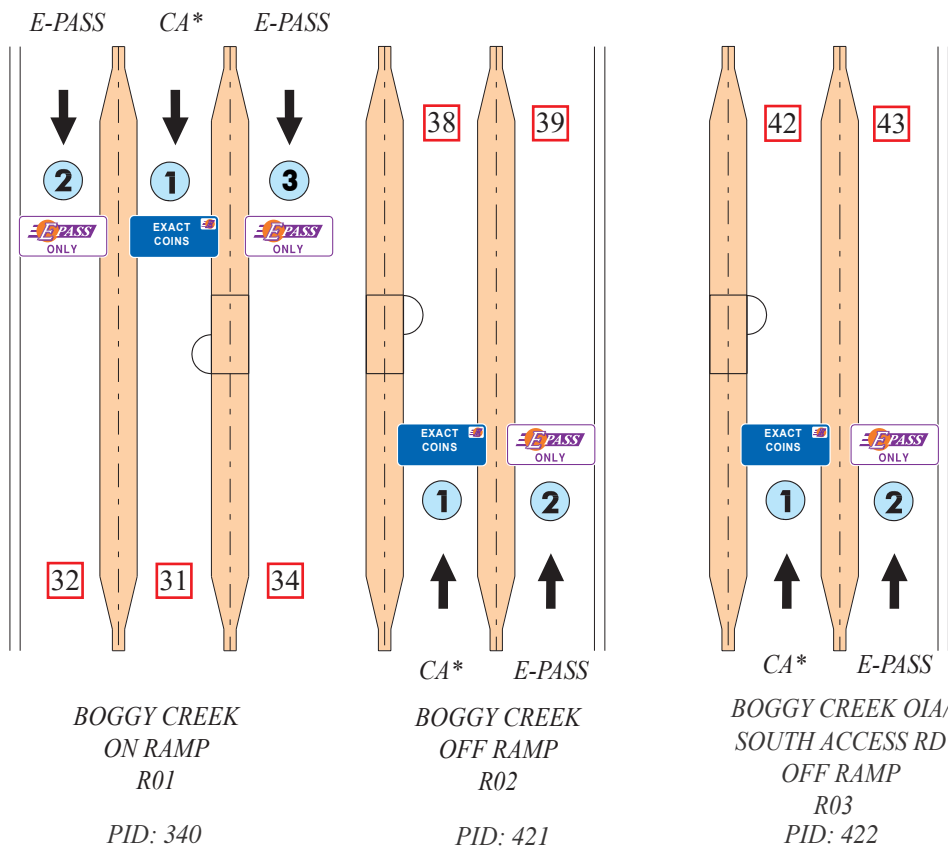
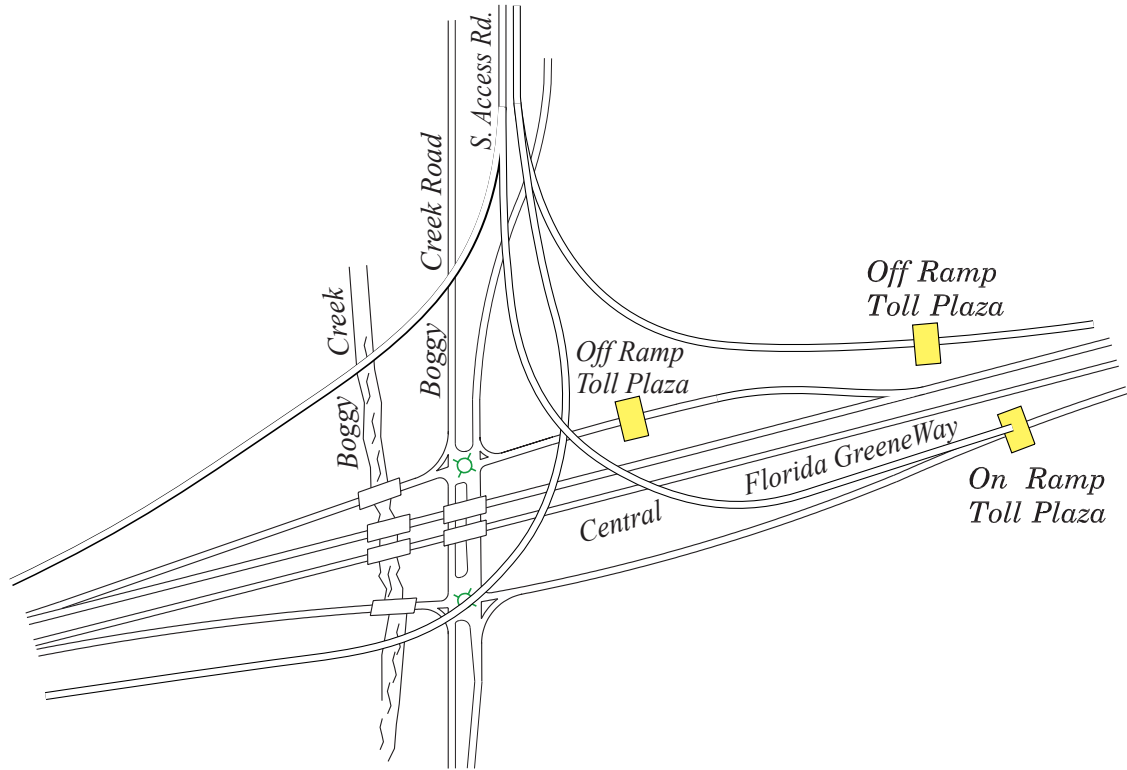

ORG-ID: 8
 FACILITY: SR 417 - BOGGY CREEK

* Changeable Message Sign (ACM/CA)

Note: All Changeable Message Signs (CMS) can display three messages: EXACT COINS, CHANGE RECEIPTS, E-PASS ONLY

Reports to Boggy Creek Mainline Toll Plaza

T:\DOCEA\DOCEA MANUAL\STol Facilities Reference Book\2016 Tolls Manual - 3/10/16-CP

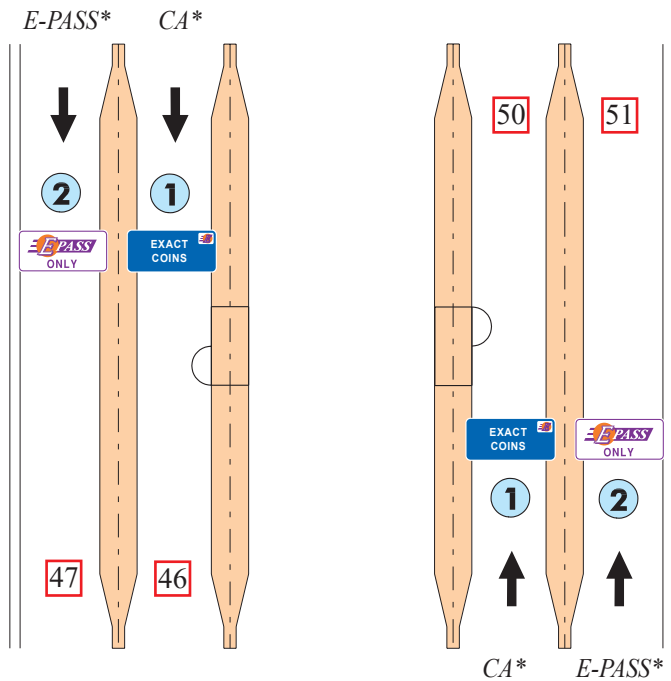
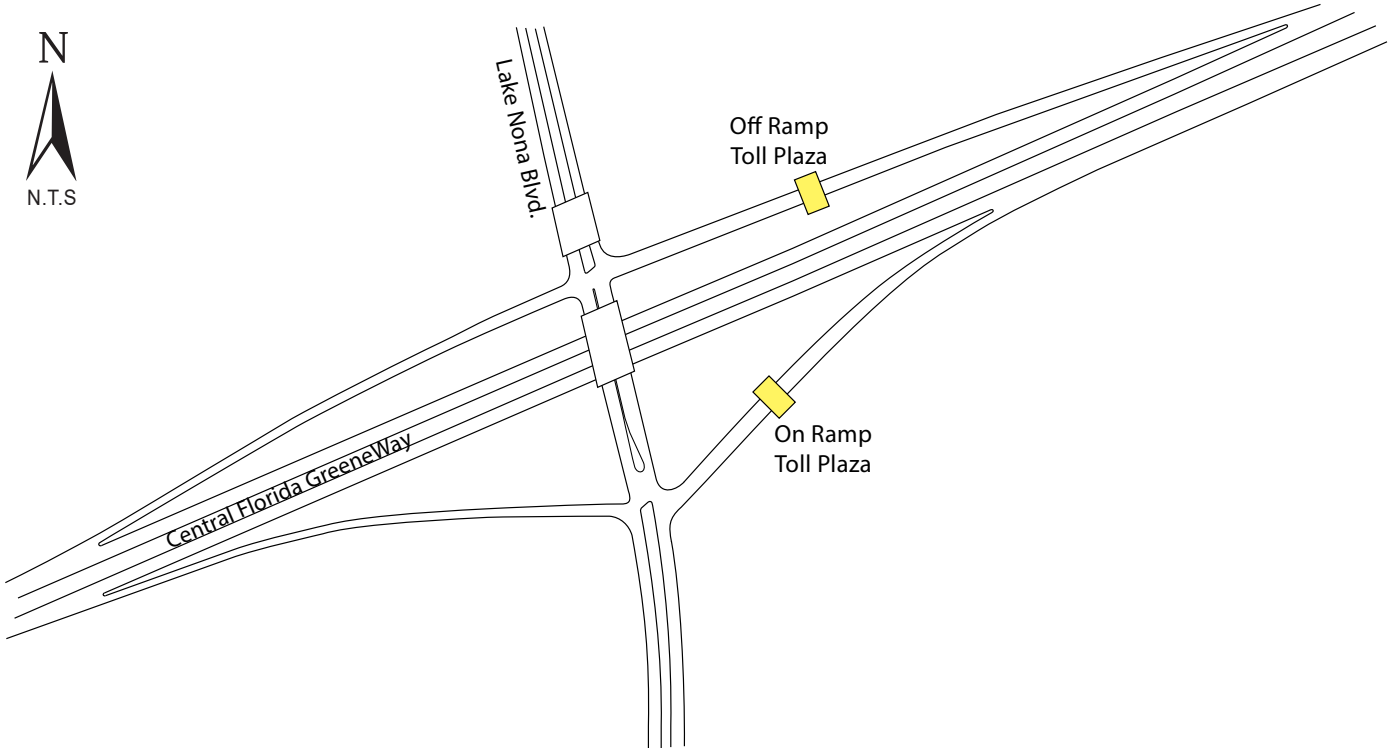

ORG-ID: 8
FACILITY: SR 417 - BOGGY CREEK

* Changeable Message Sign

LAKE NONA
ON RAMP
R04
PID: 380

LAKE NONA
OFF RAMP
R05
PID: 381

Note: All Changeable Message Signs (CMS) can display three messages: EXACT COINS, CHANGE RECEIPTS, E-PASS ONLY

Reports to Boggy Creek Mainline Toll Plaza

T:\OCEA\OCEA MANUAL\STol Facilities Reference Book\2016 Tolls Manual - 3/10/16-CP

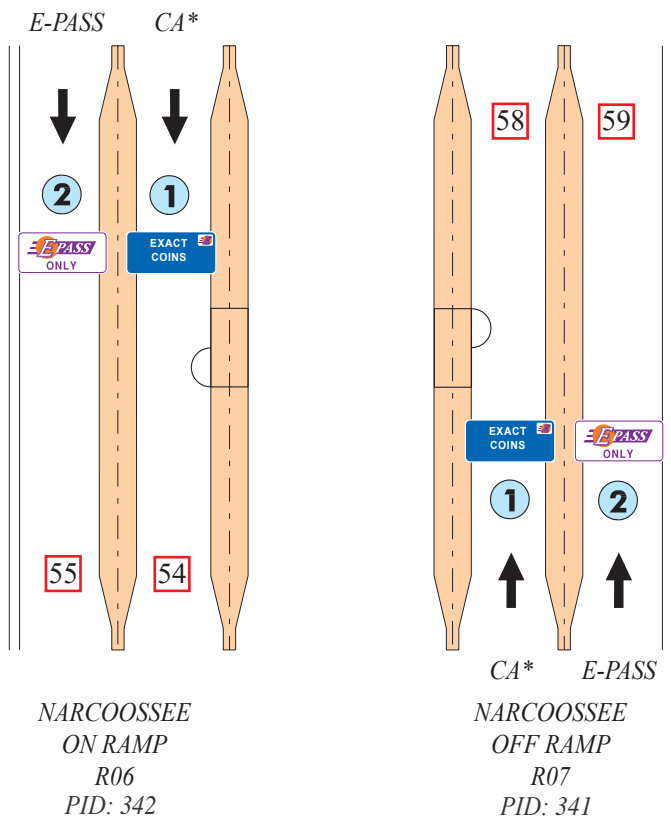
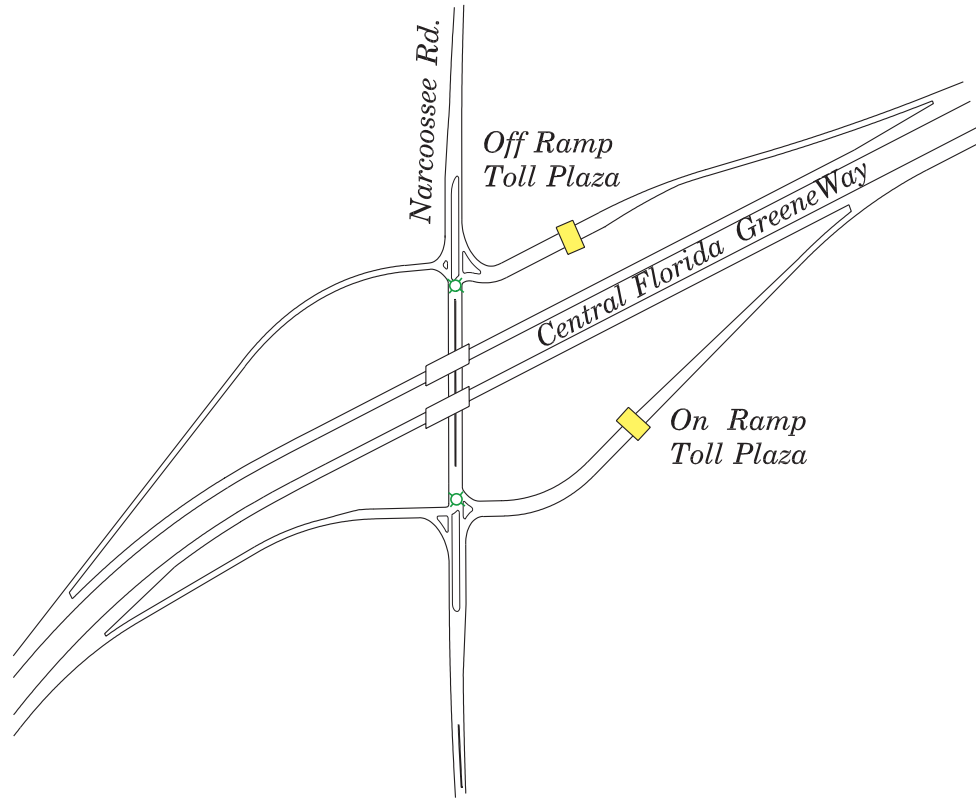

ORG-ID: 8
 FACILITY: SR 417 - BOGGY CREEK

* Changeable Message Sign

Note: All Changeable Message Signs (CMS) can display three messages: EXACT COINS, CHANGE RECEIPTS, E-PASS ONLY

Reports to Boggy Creek Mainline Toll Plaza

T:\OCEA\OCEA MANUAL\STol Facilities Reference Book\2016 Tolls Manual - 3/10/16-CP

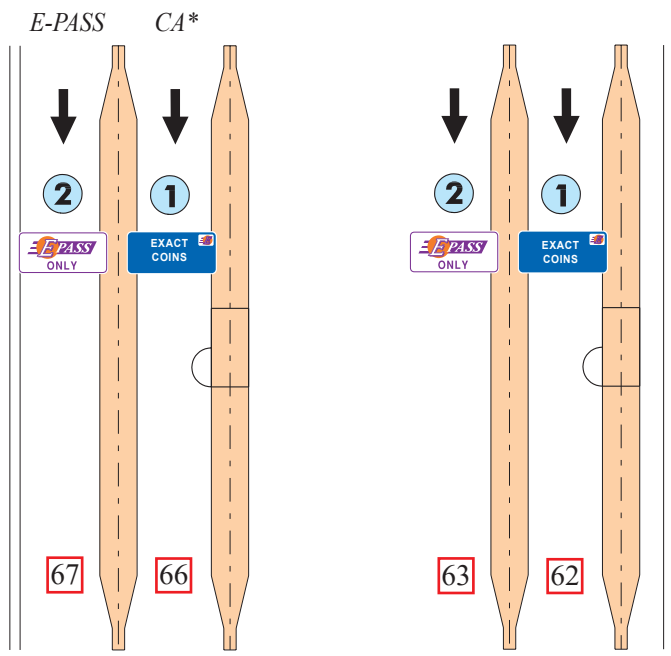
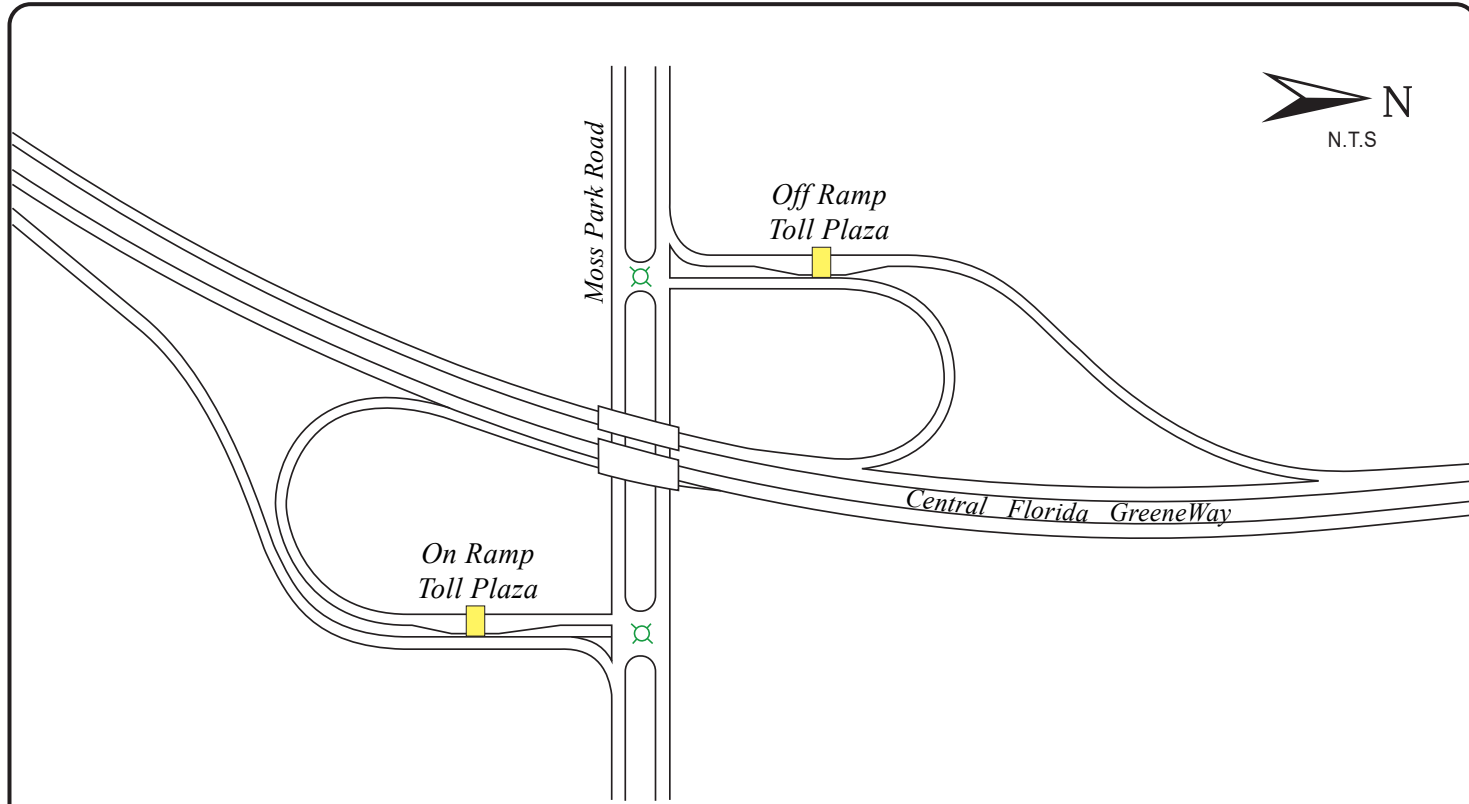

ORG-ID: 8
 FACILITY: SR 417 - BOGGY CREEK

MOSS PARK
 OFF RAMP
 R09
 PID: 411

CA* E-PASS
 MOSS PARK
 ON RAMP
 R08
 PID: 410

* Changeable Message Sign

Note: All Changeable Message Signs (CMS) can display three messages: EXACT COINS, CHANGE RECEIPTS, E-PASS ONLY

Reports to Boggy Creek Mainline Toll Plaza

T:\OCEA\OCEA MANUAL\STol Facilities Reference Book\2016 Tolls Manual - 3/10/16-CP

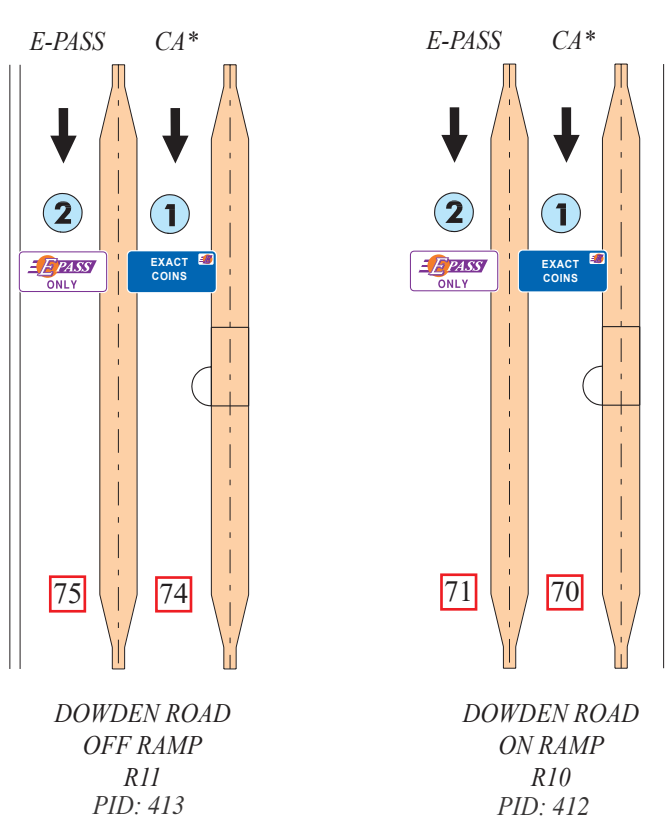
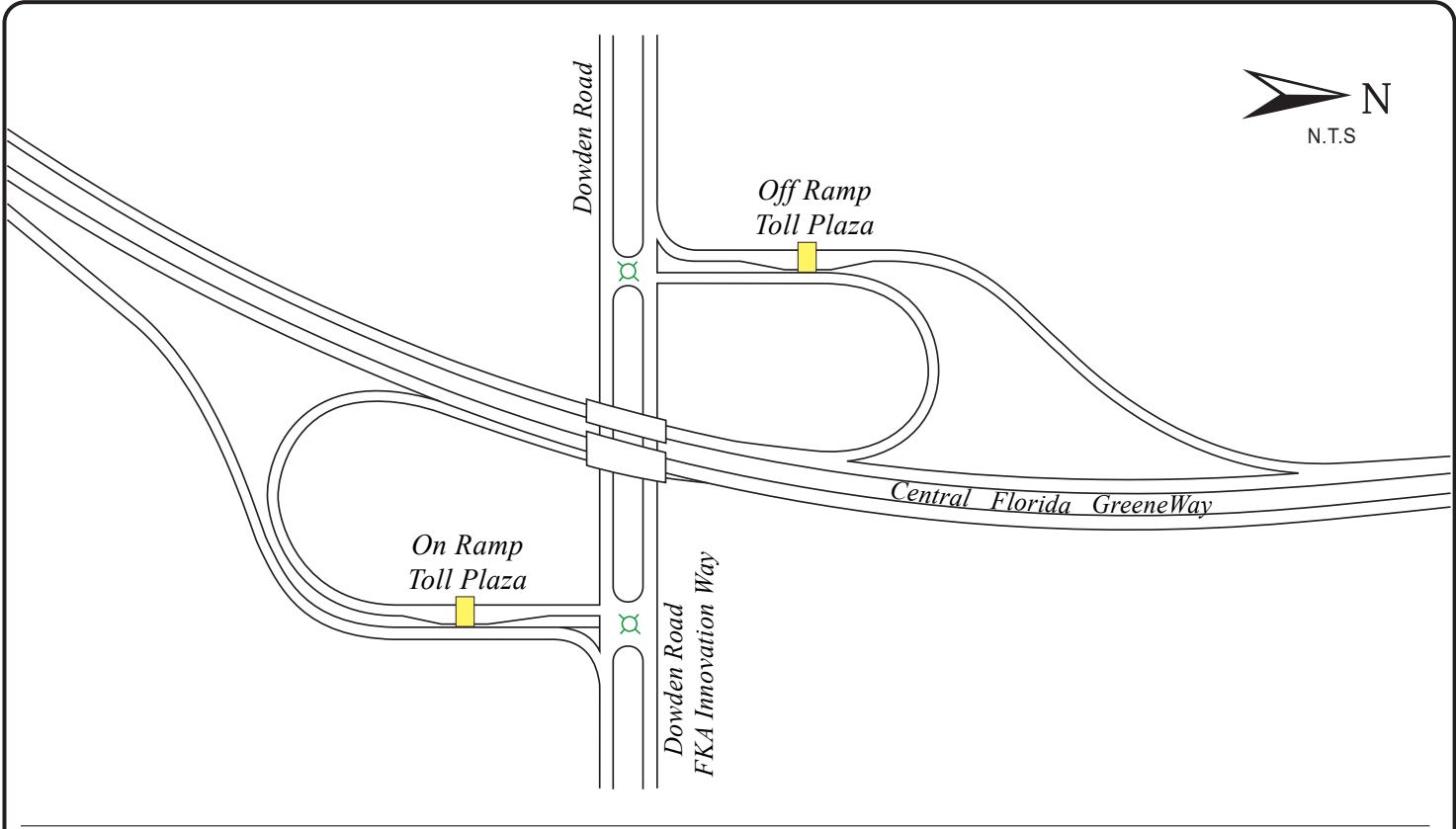

ORG-ID: 8
 FACILITY: SR 417 - BOGGY CREEK

* Changeable Message Sign

Note: All Changeable Message Signs (CMS) can display three messages: EXACT COINS, CHANGE RECEIPTS, E-PASS ONLY

Reports to Boggy Creek Mainline Toll Plaza

T:\OCEA\OCEA MANUAL\STol Facilities Reference Book\2016 Tolls Manual - 3/10/16-CP

↑
To SR 408 (East-West Expressway, SR 50 & Sanford)
 Next Interchange: Curry Ford Road
 Next Mainline Plaza: University Mainline
 Next Ramp Plaza: Curry Ford Road
 NB-ON/SB-OFF



↓
To SR 528 (Beachline) Orlando International Airport & I-4 (Walt Disney World)
 Next Interchange: Lee Vista Boulevard
 Next Mainline Plaza: Boggy Creek Mainline
 Next Ramp Plaza: Lee Vista Boulevard
 NB-OFF/SB-ON

Admin. Bldg.

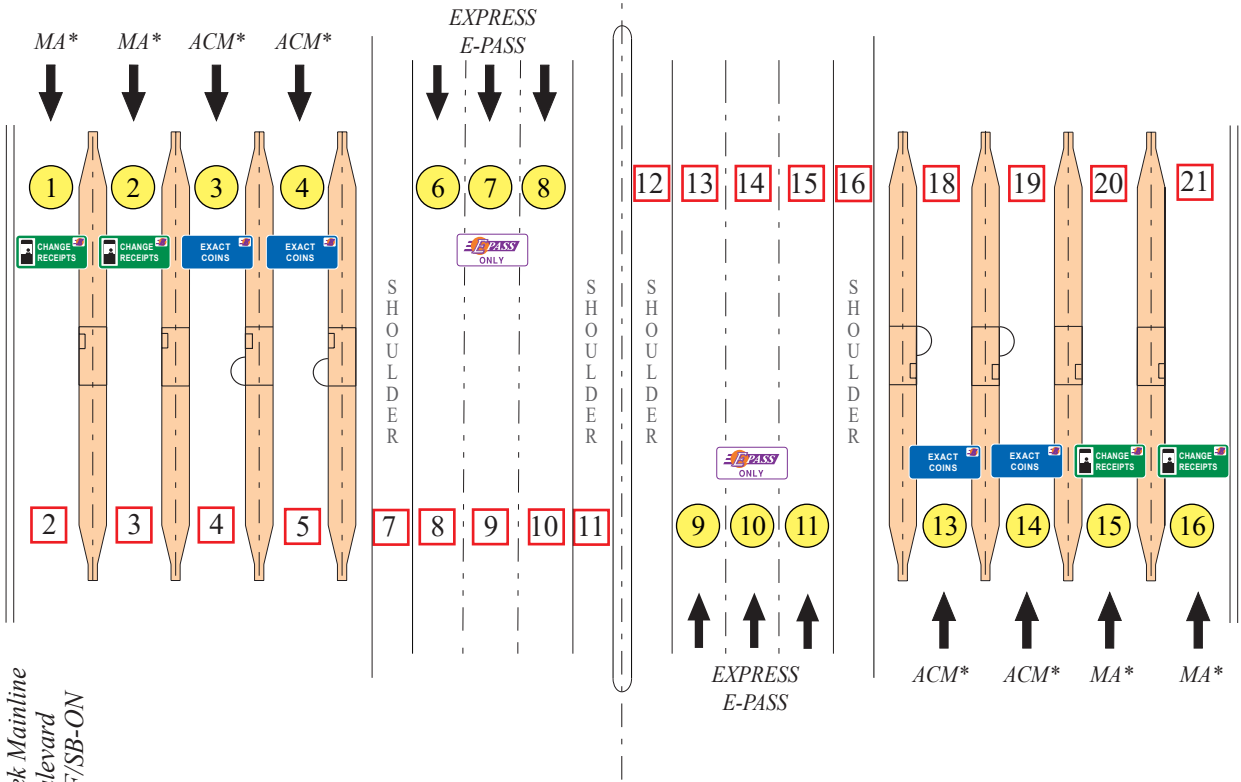

Note: All Changeable Message Signs (CMS) can display three messages: EXACT COINS, CHANGE RECEIPTS, E-PASS ONLY

ORG-ID: 6	PID: 328
FACILITY: SR 417 - CURRY FORD	

- LANES OF EQUIPMENT
- 6 Express E-PASS (E-PASS only)
 - 4 Booths with Automatic Coin Machines with E-PASS (ACM)
 - 4 Manned Booths with E-PASS (MA)
 - * Changeable Message Sign

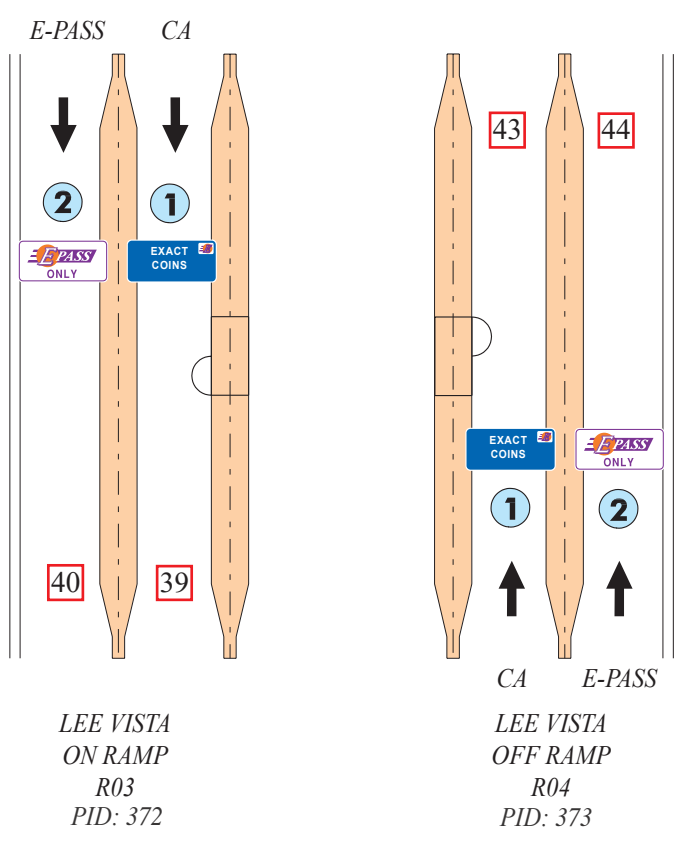
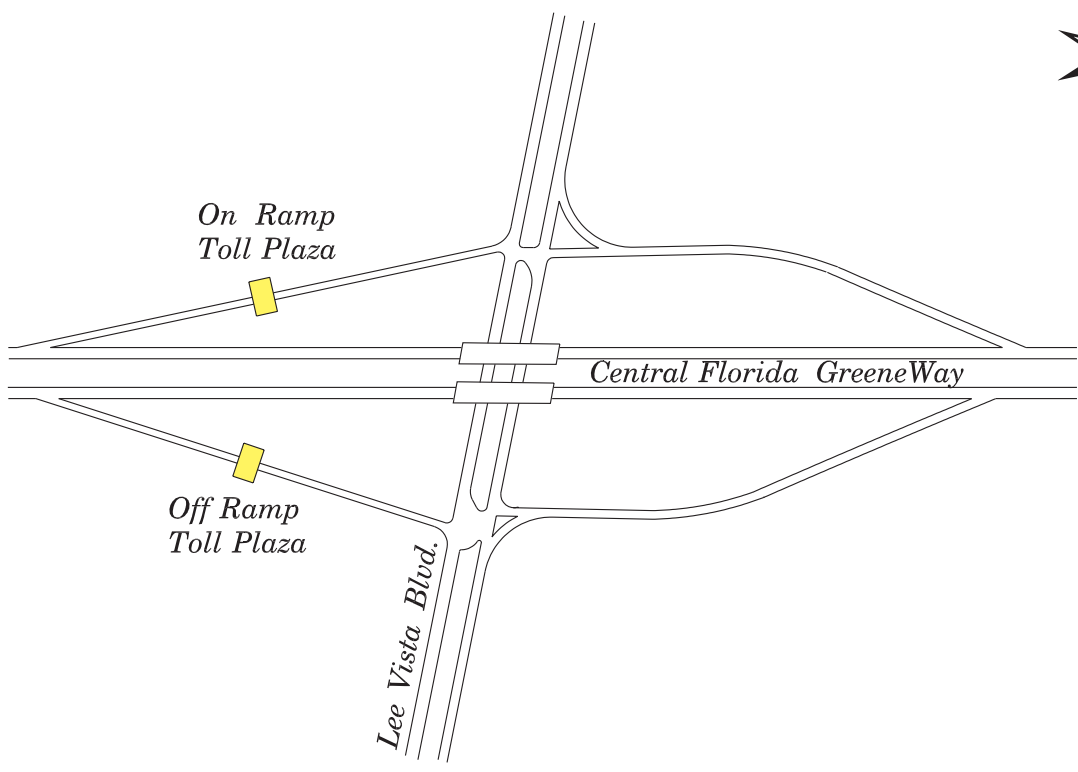

ORG-ID: 6
 FACILITY: SR 417 - CURRY FORD

Reports to Curry Ford Mainline Toll Plaza

T:\OCEA\OCEA MANUAL\STol Facilities Reference Book\2016 Tolls Manual - 3/10/16-CP

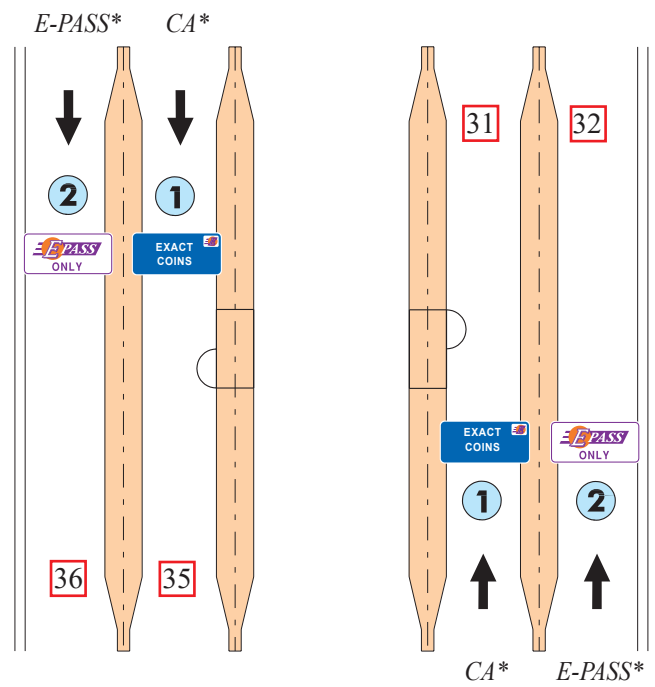
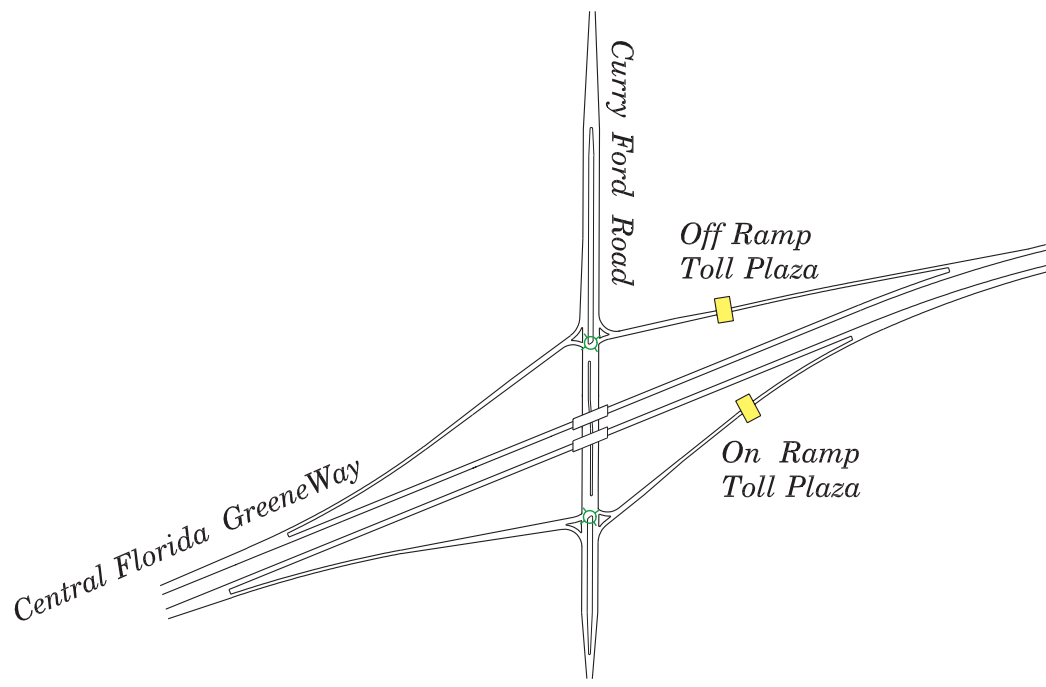

ORG-ID: 6
 FACILITY: SR 417 - CURRY FORD

* Changeable Message Sign

CURRY FORD
 OFF RAMP
 R02
 PID: 330

CURRY FORD
 ON RAMP
 R01
 PID: 329

Note: All Changeable Message Signs (CMS) can display three messages: EXACT COINS, CHANGE RECEIPTS, E-PASS ONLY

Reports to Curry Ford Mainline Toll Plaza

T:\OCEA\OCEA MANUAL\STol Facilities Reference Book\2016 Tolls Manual - 3/10/16-CP

↑
To US 17, 92 & US 441
 Next Interchange: University Boulevard
 Next Mainline Plaza: Lake Jessup Mainline (Turnpike)
 Next Ramp Plaza: Aloma Ave. (Turnpike) NB-OFF/SB-ON

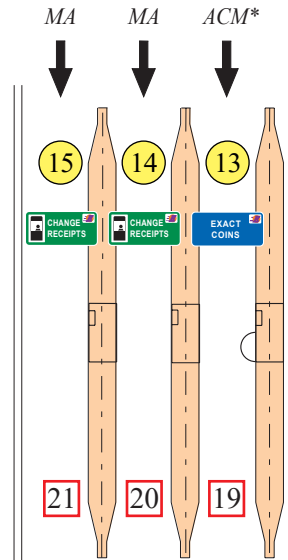

↓
To SR 50 (Colonial Drive), SR 408 & SR 528
 Next Interchange: SR 50
 Next Mainline Plaza: Curry Ford Mainline
 Next Ramp Plaza: SR 50 (Colonial Drive) NB-OFF/SB-ON

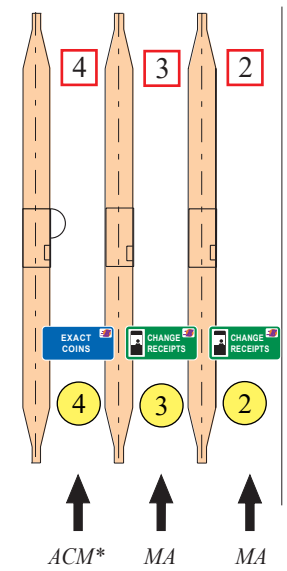
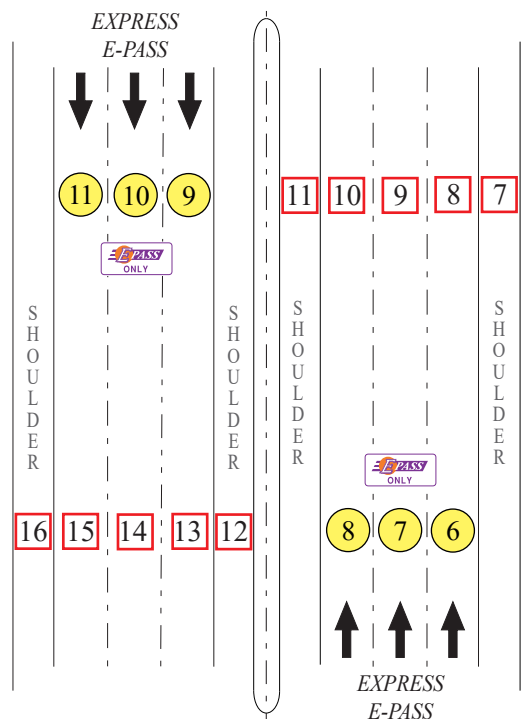

Admin. Bldg.

Note: All Changeable Message Signs (CMS) can display three messages: EXACT COINS, CHANGE RECEIPTS, E-PASS ONLY

ORG-ID: 3	PID: 301
FACILITY: SR 417 - UNIVERSITY	

- LANES OF EQUIPMENT
- 6 Express E-PASS (E-PASS only)
 - 2 Booths with Automated Coin Machines with E-PASS (ACM)
 - 4 Manned Booths with E-PASS (MA)
 - * Changeable Message Sign

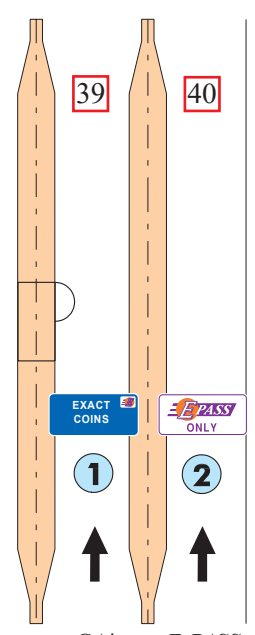
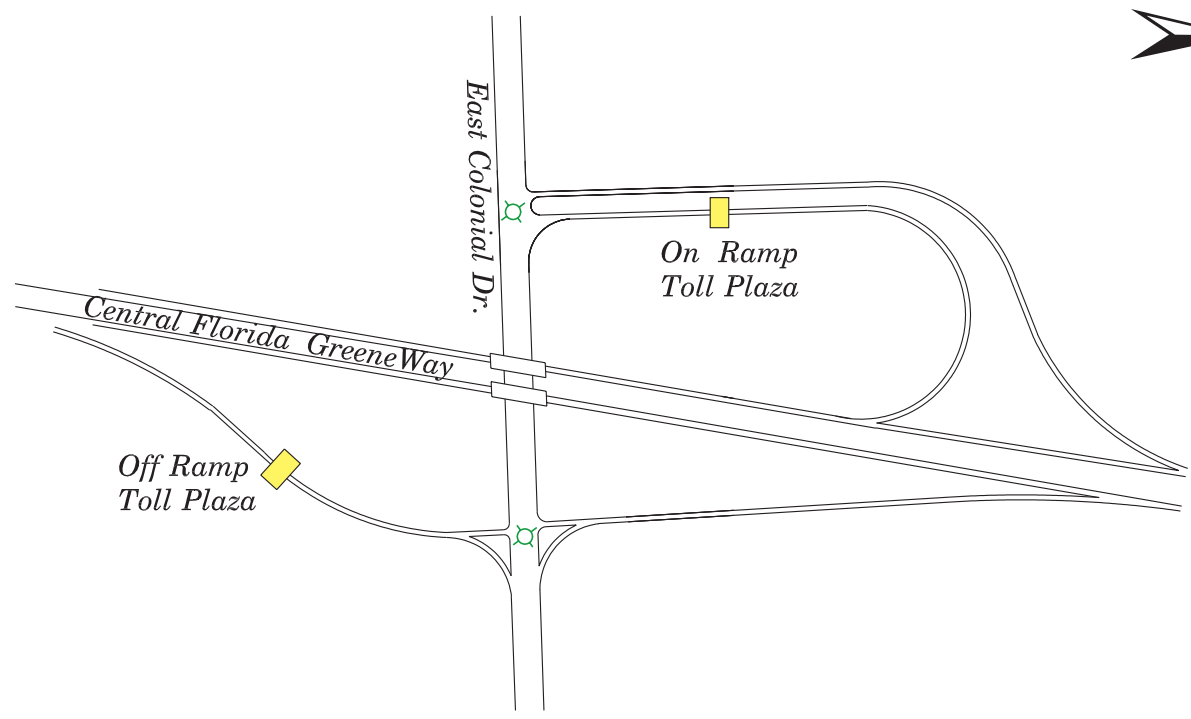

EAST COLONIAL
ON RAMP
R03
PID: 304

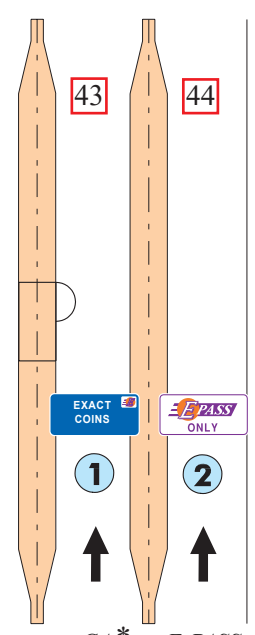

EAST COLONIAL
OFF RAMP
R04
PID: 305

ORG-ID: 3
FACILITY: SR 417 - UNIVERSITY

* Changeable Message Sign

Note: All Changeable Message Signs (CMS) can display three messages: EXACT COINS, CHANGE RECEIPTS, E-PASS ONLY

Reports to University Mainline Toll Plaza

T:\OCEA\OCEA MANUAL\STol Facilities Reference Book\2016 Tolls Manual - 3/10/16-CP

T:\OCEA\OCEA MANUAL\STol Facilities Reference Book\2016 Tolls Manual - 3/10/16-CP

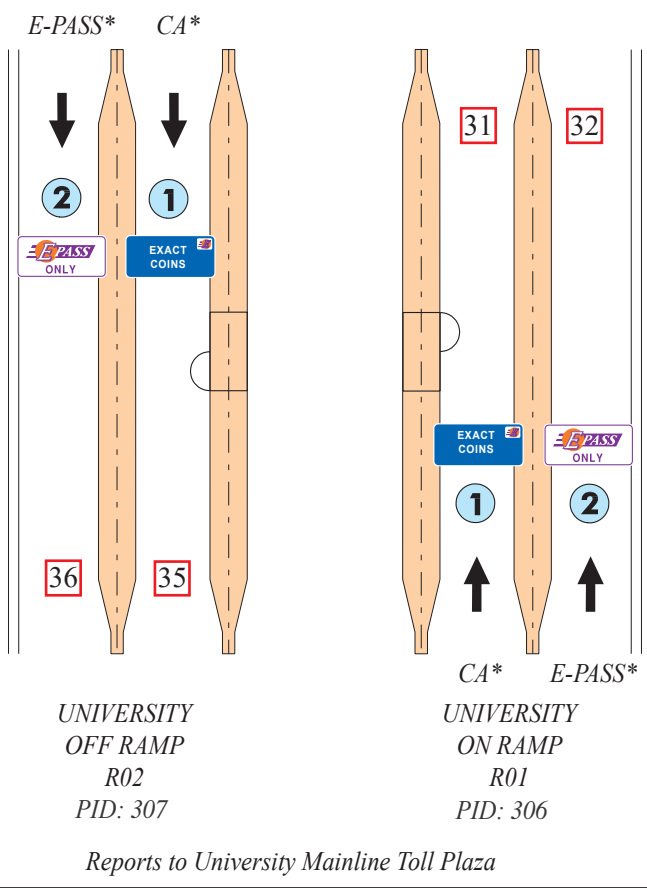
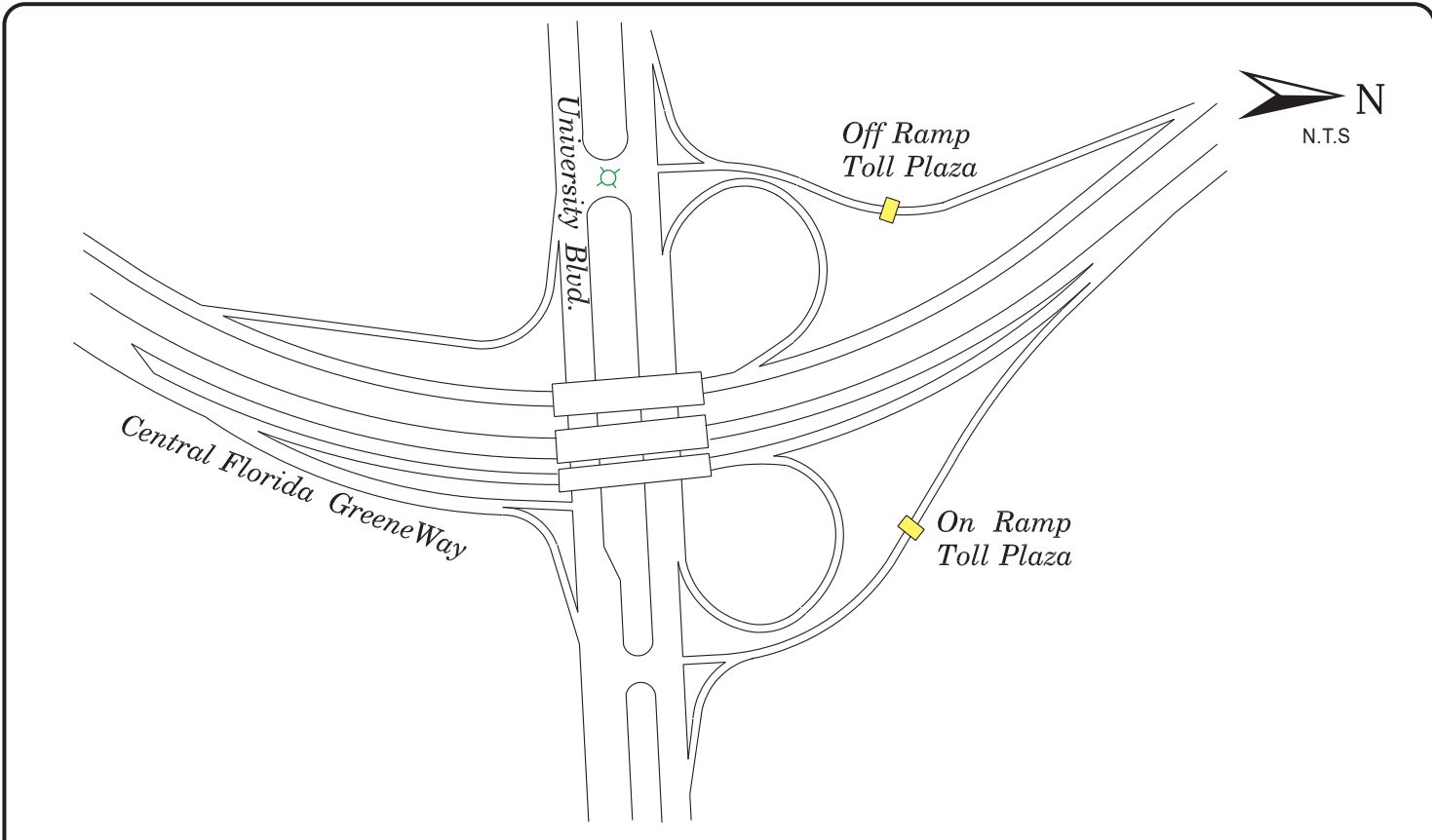

ORG-ID: 3
 FACILITY: SR 417 - UNIVERSITY

* Changeable Message Sign

Note: All Changeable Message Signs (CMS) can display three messages: EXACT COINS, CHANGE RECEIPTS, E-PASS ONLY

Western Beltway



Mainline Toll Plazas and Associated Tolloed Ramps

LEGEND

For Lane Designations for all Plazas

CA - Exact Coin with E-PASS

MA - Change Receipts (Manned) with E-PASS

*ACM - Booth with Manual Lane Terminal,
Automatic Coin Machine and E-PASS*



To US 441, Apopka

Next Interchange: CR 437A
 Next Mainline Plaza: None
 Next Ramp Plaza: None

Admin.
Bldg.

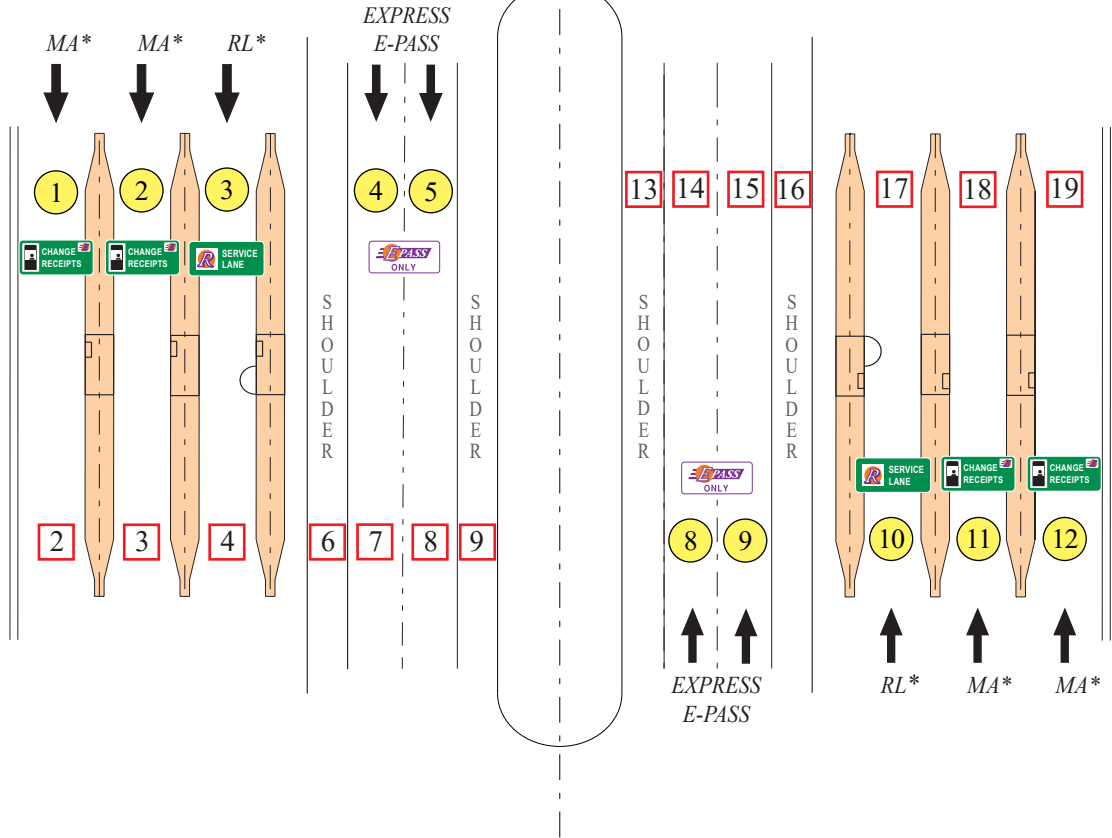

To SR 50 & Florida's Turnpike

Next Interchange: West Rd.
 Next Mainline Plaza: Independence Mainline
 Next Ramp Plaza: West Rd.
 NB-OFF/SB-ON



Note: All Changeable Message Signs (CMS) can display three messages: EXACT COINS, CHANGE RECEIPTS, E-PASS ONLY

ORG-ID: 10	PID: 367
FACILITY: SR 429 - FOREST LAKE	

LANES OF EQUIPMENT

- 4 Manned Booth with E-PASS (MA)
- 2 E-PASS Reload Lane (RL)
- 4 Express E-PASS (E-PASS only)
- * Changeable Message Sign

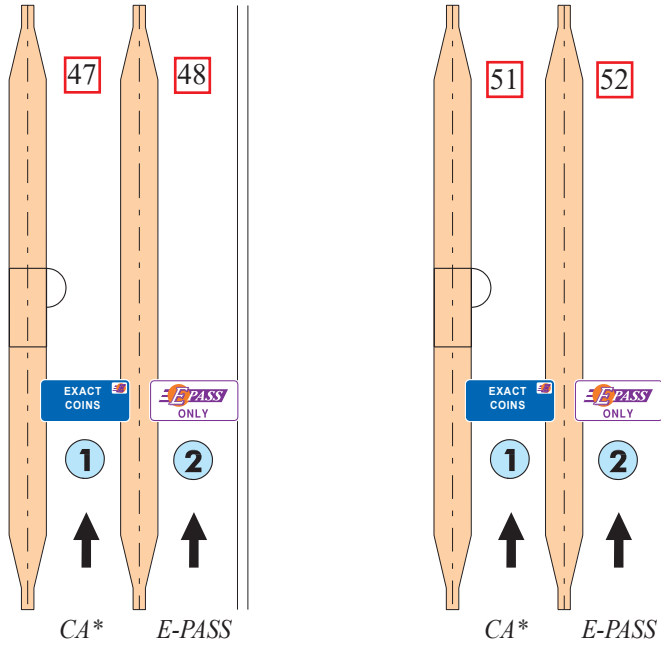
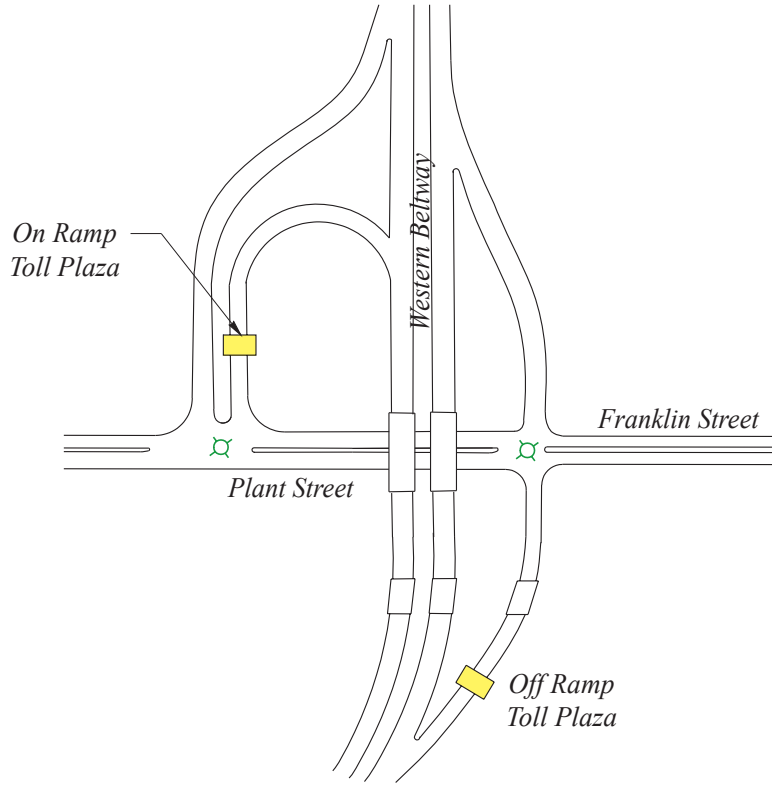

ORG-ID: 10
 FACILITY: SR 429 - FOREST LAKE

* Changeable Message Sign

SR 438
 ON RAMP
 R05
 PID: 370

SR 438
 OFF RAMP
 R06
 PID: 371

Note: All Changeable Message Signs (CMS) can display three messages: EXACT COINS, CHANGE RECEIPTS, E-PASS ONLY

Reports to Forest Lake Mainline Toll Plaza

T:\OCEA\OCEA MANUAL\STol Facilities Reference Book\2016 Tolls Manual - 3/10/16-CP

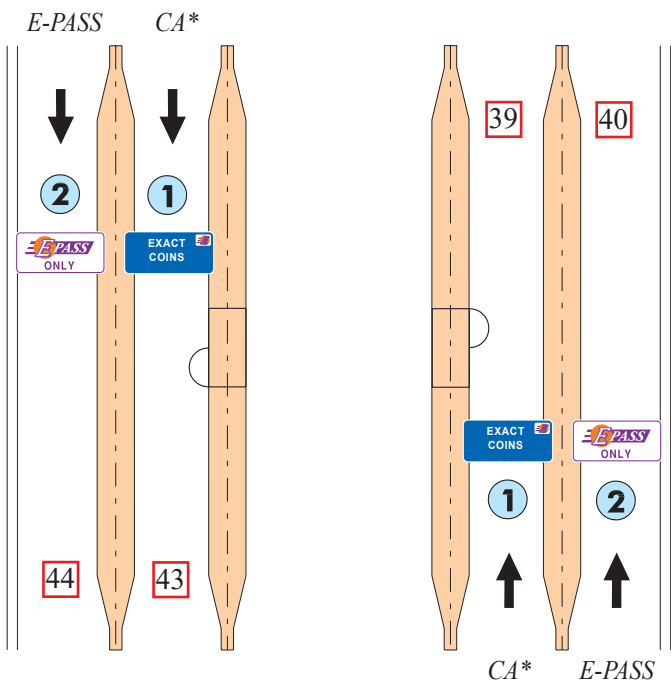
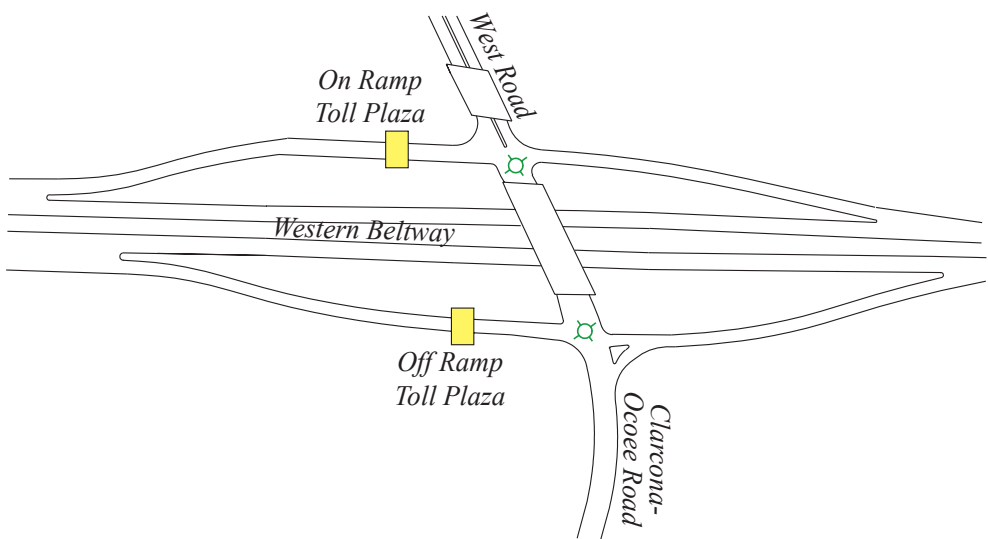

WEST RD.
OFF RAMP
R04
PID: 369

WEST RD.
ON RAMP
R03
PID: 368

ORG-ID: 10
FACILITY: SR 429 - FOREST LAKE

* Changeable Message Sign

Note: All Changeable Message Signs (CMS) can display three messages: EXACT COINS, CHANGE RECEIPTS, E-PASS ONLY

Reports to Forest Lake Mainline Toll Plaza

T:\OCEA\OCEA MANUAL\STol Facilities Reference Book\2016 Tolls Manual - 3/10/16-CP

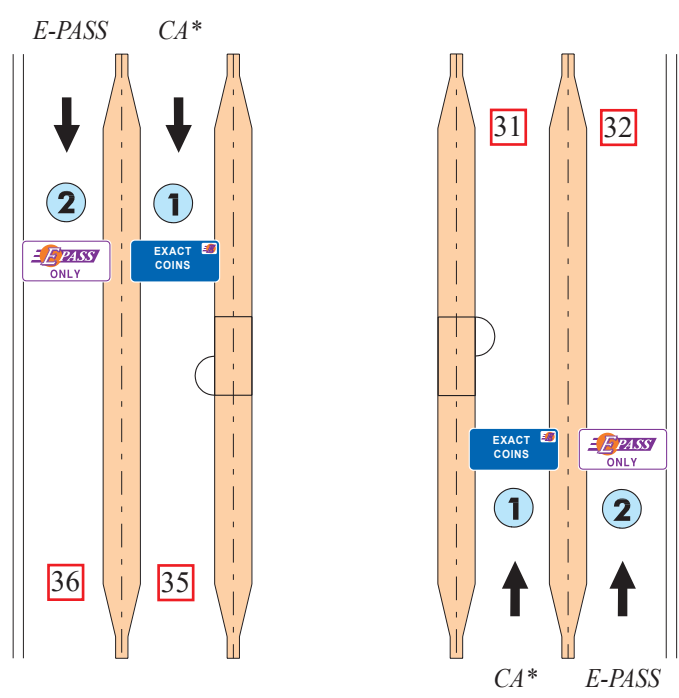
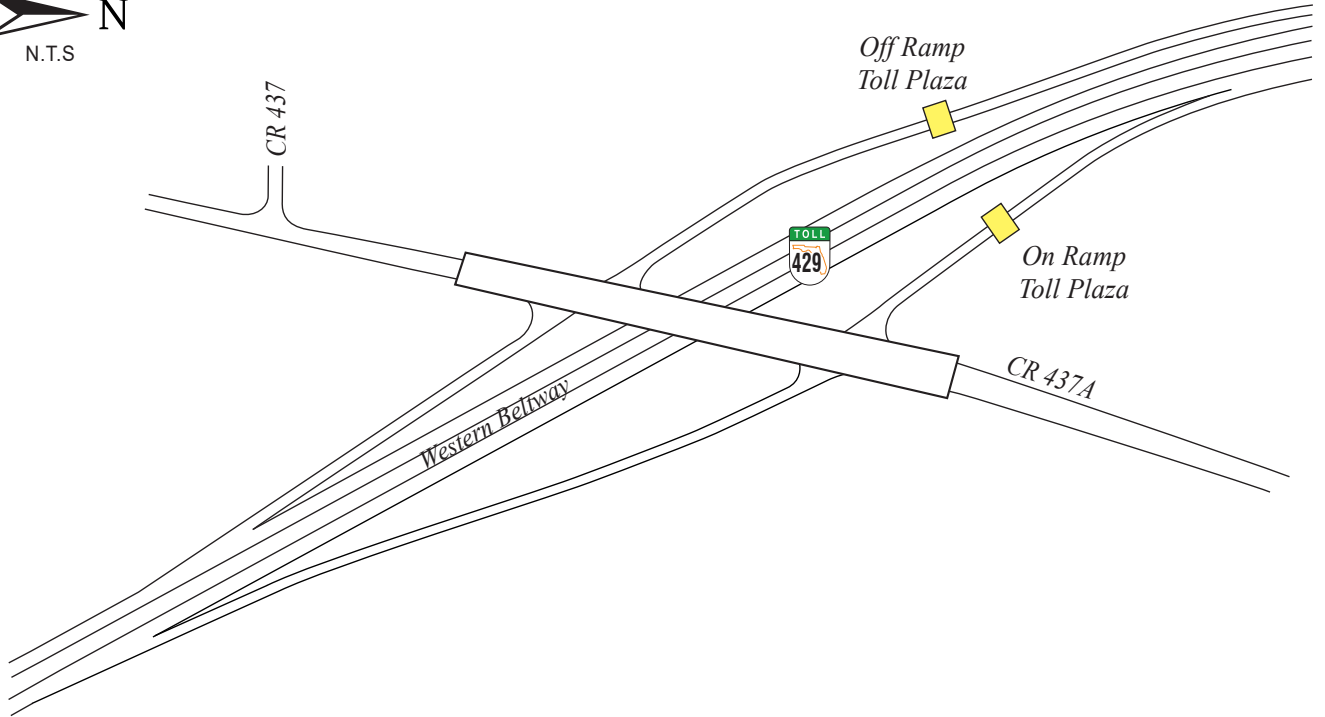

ORG-ID: 10
 FACILITY: SR 429 - FOREST LAKE

* Changeable Message Sign

CR 437A
 OFF RAMP
 R02
 PID: 418

CR 437A
 ON RAMP
 R01
 PID: 417

Reports to Forest Lake Mainline Toll Plaza

Note: All Changeable Message Signs (CMS) can display three messages: EXACT COINS, CHANGE RECEIPTS, E-PASS ONLY

T:\OCEA\OCEA MANUAL\STol Facilities Reference Book\2016 Tolls Manual - 3/10/16-CP

↑
To Florida's Turnpike, S.R. 50 & Apopka (US 441)
 Next Interchange: C.R. 535
 Next Mainline Plaza: Forest Lake Mainline
 Next Ramp Plaza: C.R. 535
 NB-ON / SB-OFF



Admin.
Bldg.

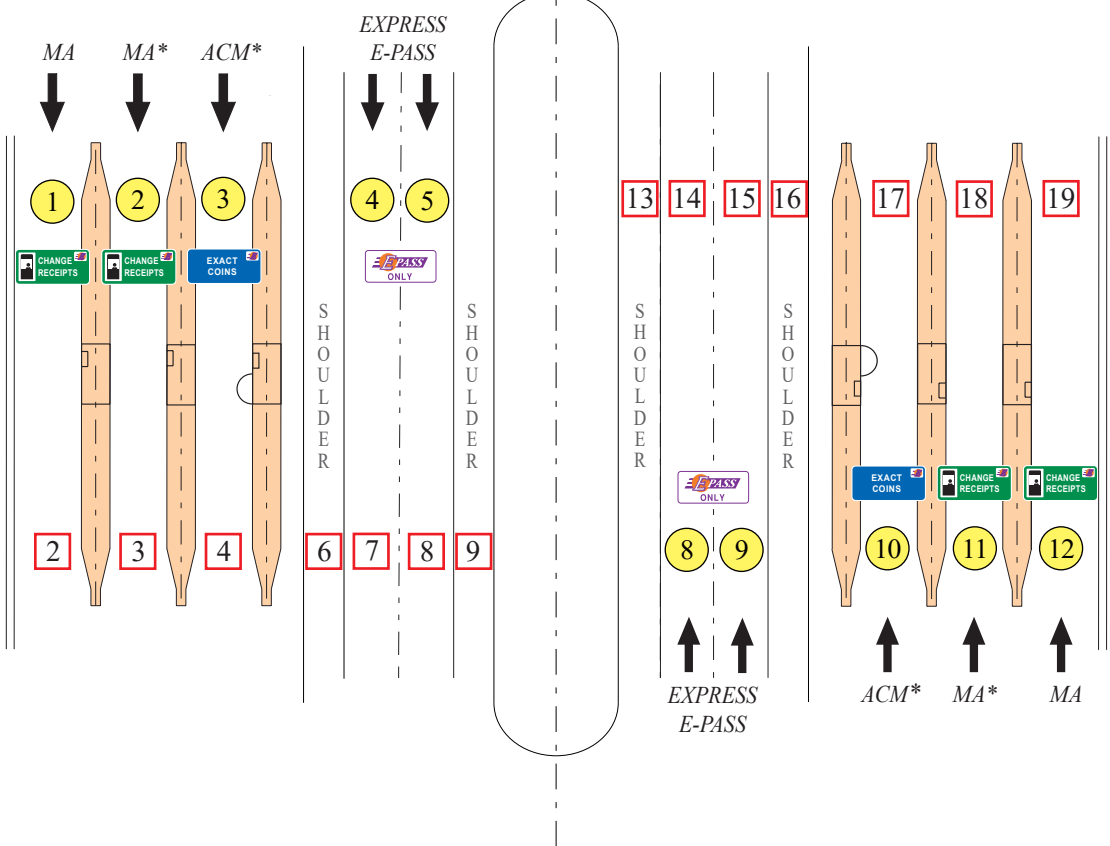

↓
To New Independence Parkway, U.S. 192 & I-4
 Next Interchange: New Independence Pkwy.
 Next Mainline Plaza: SR 429 South Mainline (Turnpike)
 Next Ramp Plaza: New Independence Pkwy.
 SB-ON / NB-OFF

Note: All Changeable Message Signs (CMS) can display three messages: EXACT COINS, CHANGE RECEIPTS, E-PASS ONLY

ORG-ID: 11 PID: 375
 FACILITY: SR 429 - INDEPENDENCE

- LANES OF EQUIPMENT
- 4 Manned Booths with E-PASS (MA)
 - 2 Booths with ACM and E-PASS
 - 4 Express E-PASS (E-PASS only)
 - * Changeable Message Sign

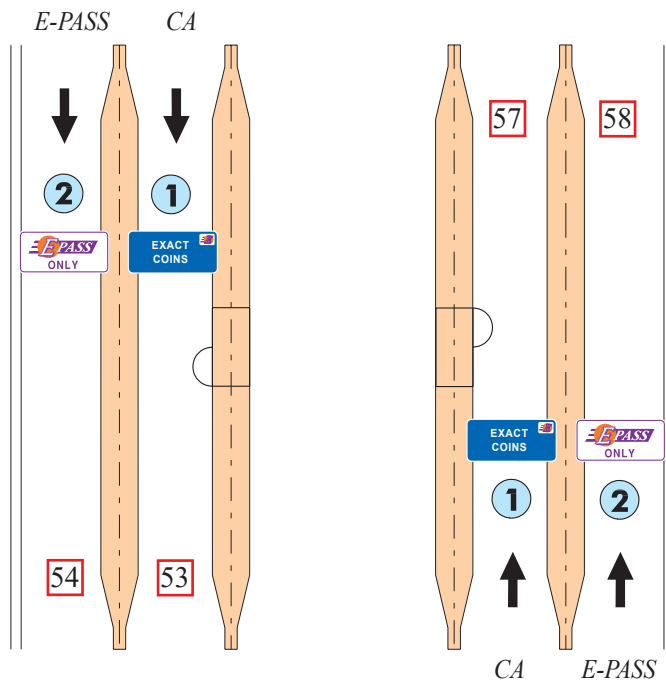
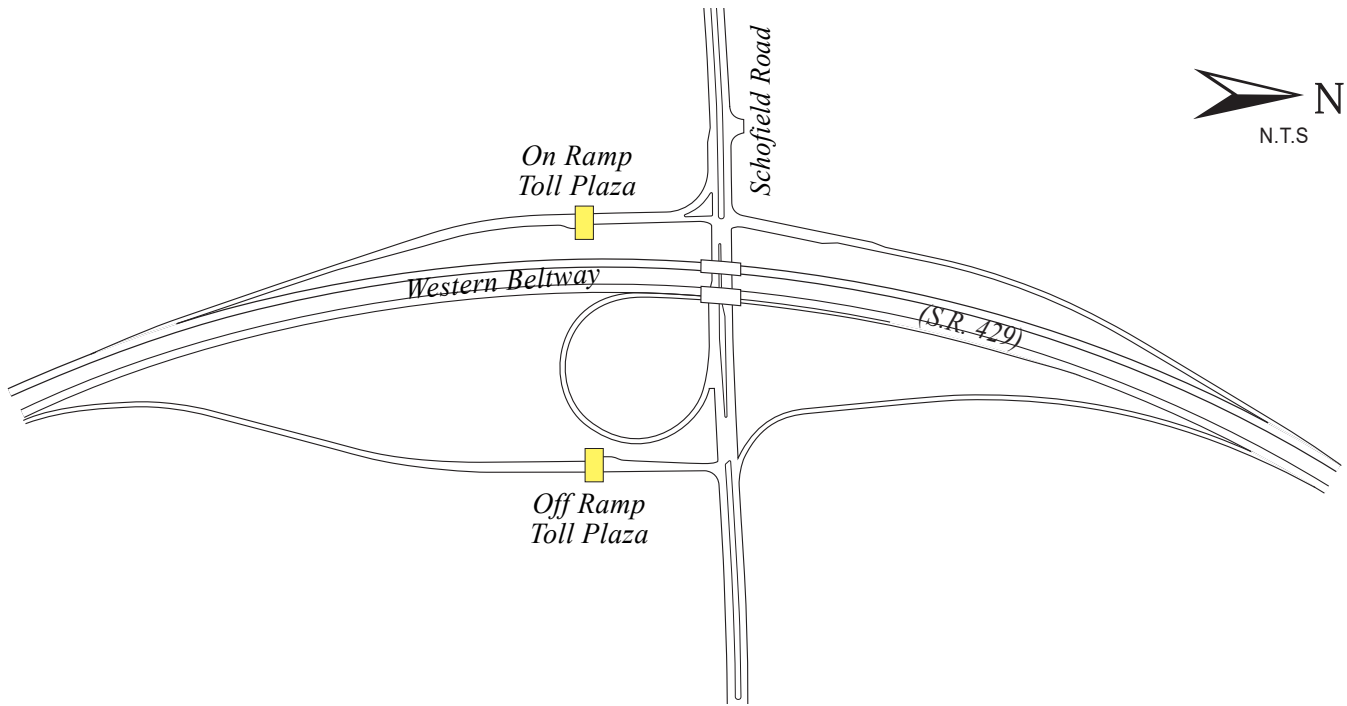

ORG-ID: 11
 FACILITY: SR 429 - INDEPENDENCE

SCHOFIELD
 ON RAMP
 R05
 PID: 419

SCHOFIELD
 OFF RAMP
 R06
 PID: 420

Reports to Independence Mainline Toll Plaza

T:\OCEA\OCEA MANUAL\STol Facilities Reference Book\2016 Tolls Manual - 3/10/16-CP

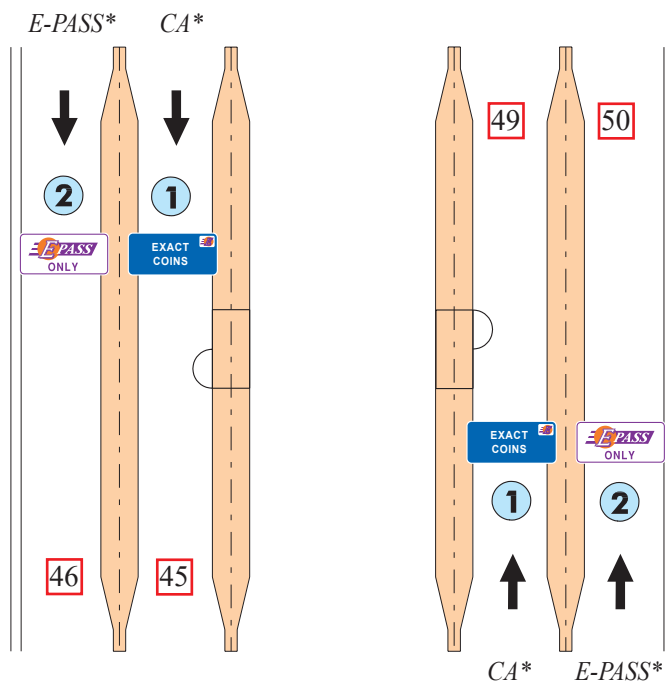
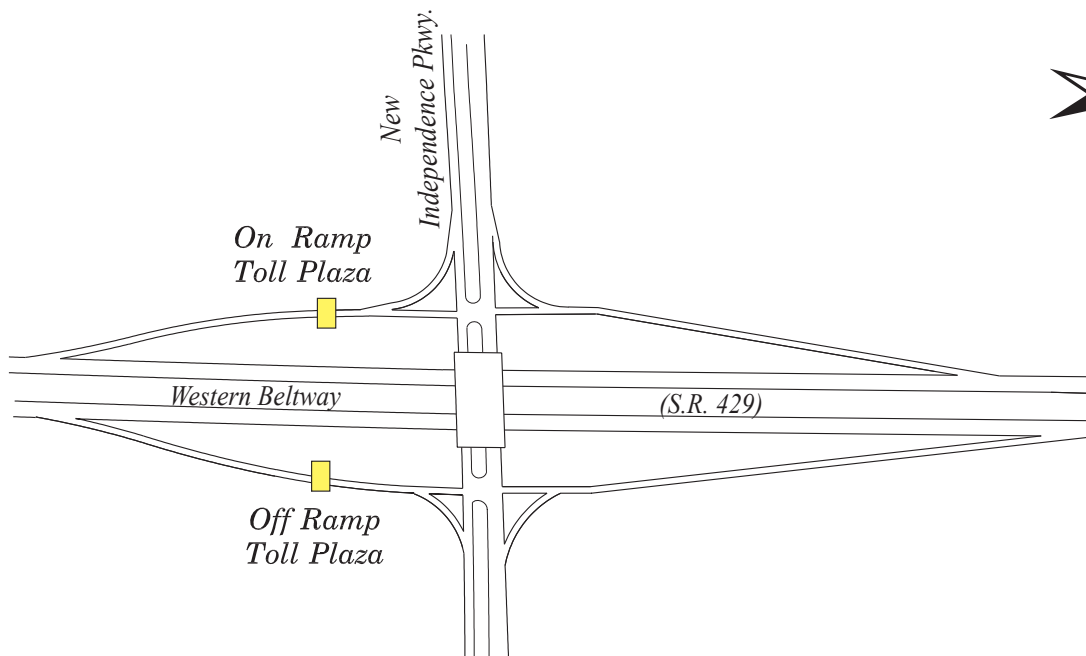

ORG-ID: 11
 FACILITY: SR 429 - INDEPENDENCE

* Changeable Message Sign

Note: All Changeable Message Signs (CMS) can display three messages: EXACT COINS, CHANGE RECEIPTS, E-PASS ONLY

Reports to Independence Mainline Toll Plaza

T:\OCEA\OCEA MANUAL\STol Facilities Reference Book\2016 Tolls Manual - 3/10/16-CP

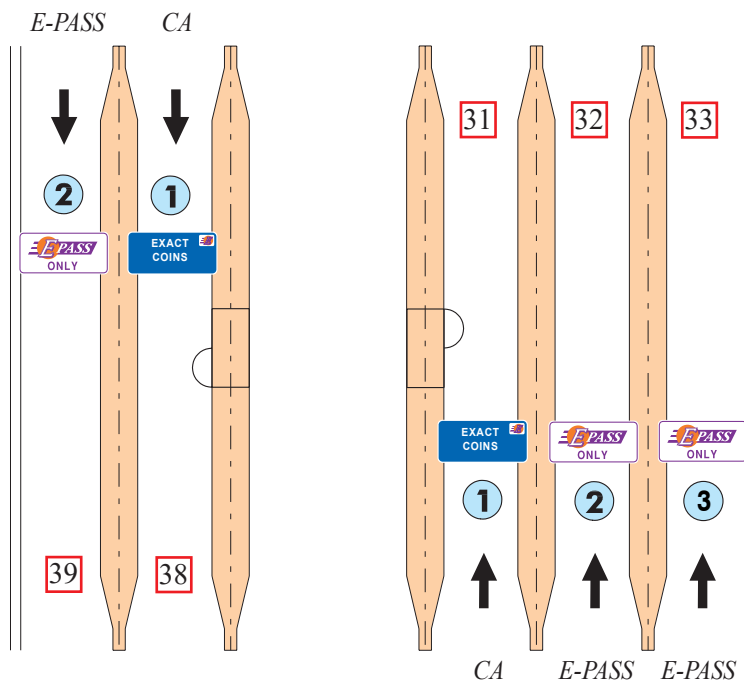
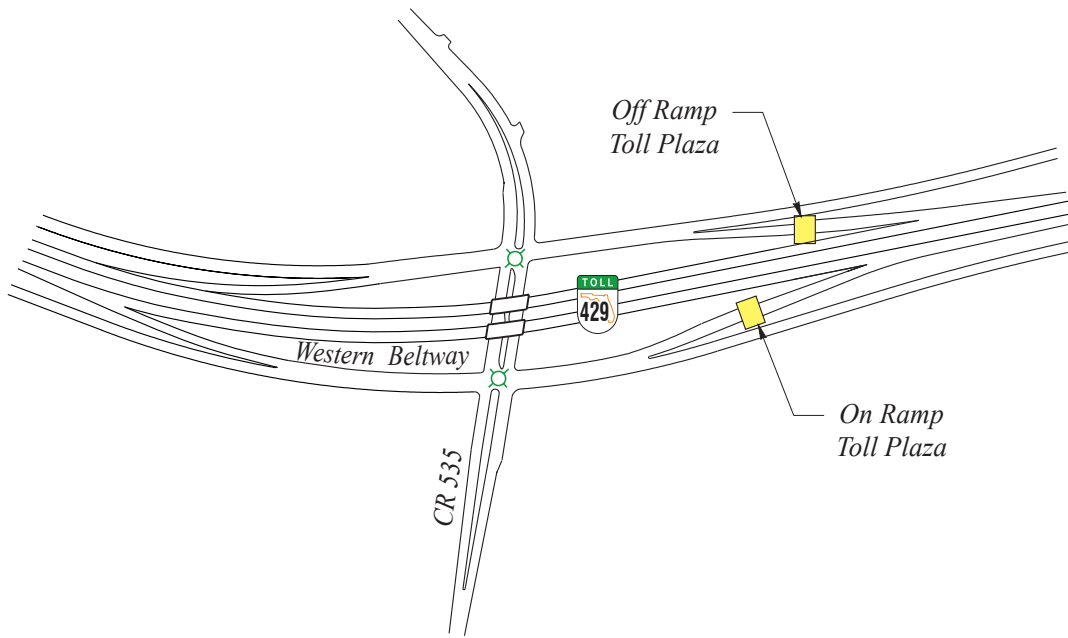

ORG-ID: 11
 FACILITY: SR 429 - INDEPENDENCE

CR 535
 OFF RAMP
 R02
 PID: 377

CR 535
 ON RAMP
 R01
 PID: 376

Reports to Independence Mainline Toll Plaza

T:\DOCEA\DOCEA MANUAL\STol Facilities Reference Book\2016 Tolls Manual - 3/10/16-CP

To Kelly Park Rd., SR 453
, Mount Dora & Leesburg
↑

To SR 429 (Connector Rd.)
SR 441 (Orange Blossom Tr.),
SR 437 (Plymouth Sorrento Rd.)
↓

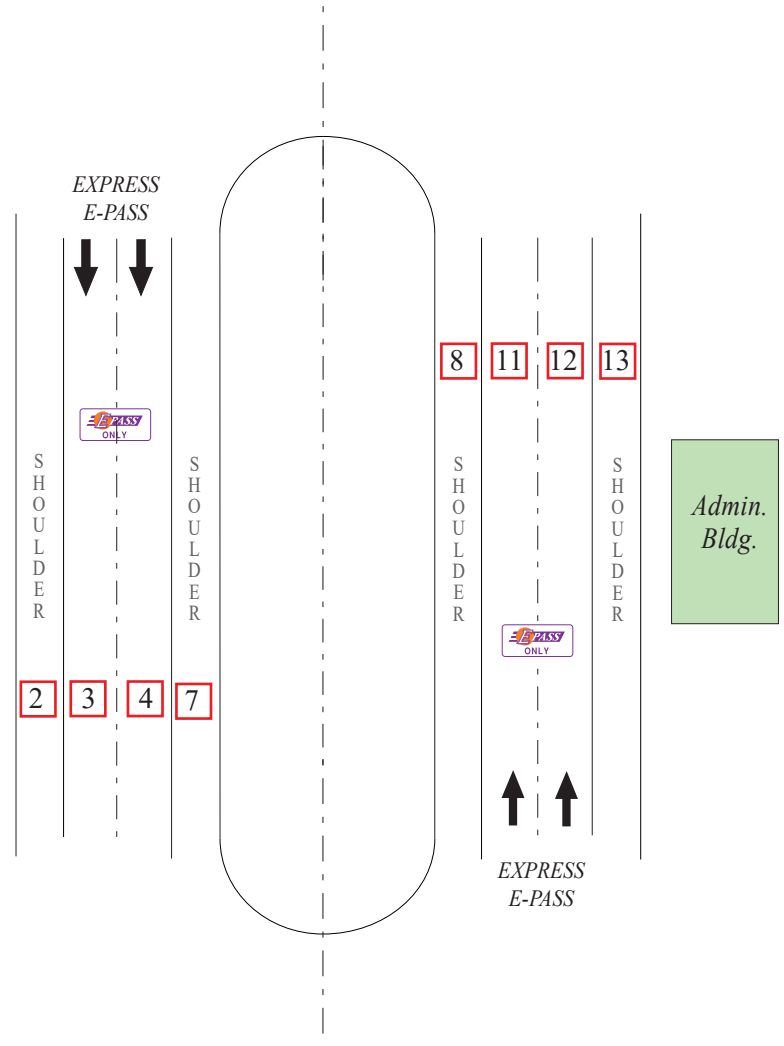

ORG-ID: 16	PID: 433
FACILITY: SR 429 - PONKAN	

LANES OF EQUIPMENT
4 Express E-PASS (E-PASS only)

To SR 46 ↑

To SR 453, South SR 429
Mount Dora & Leasburg

↓

Next Interchange: SR 453
Next Mainline Plaza: Coronado SB Mainline Toll Gantry

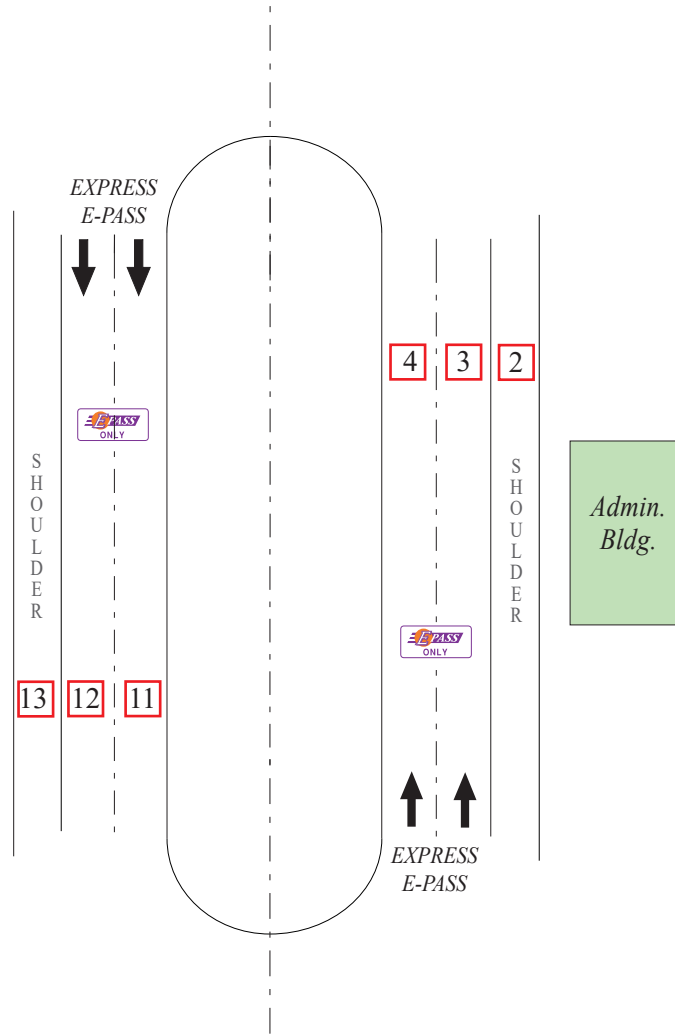

ORG-ID: 21	PID: 434
FACILITY: SR 429 - Mt. PLYMOUTH	

LANES OF EQUIPMENT
4 Express E-PASS (E-PASS only)

Mount-Dora Connector

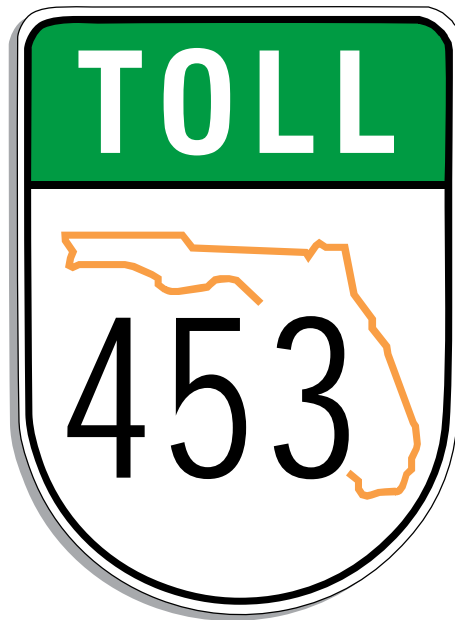

Mainline Toll Plaza

LEGEND

For Lane Designations for all Plazas

AET - Express Lanes



To SR 46 ↑

↓ To SR 429 & SR 453

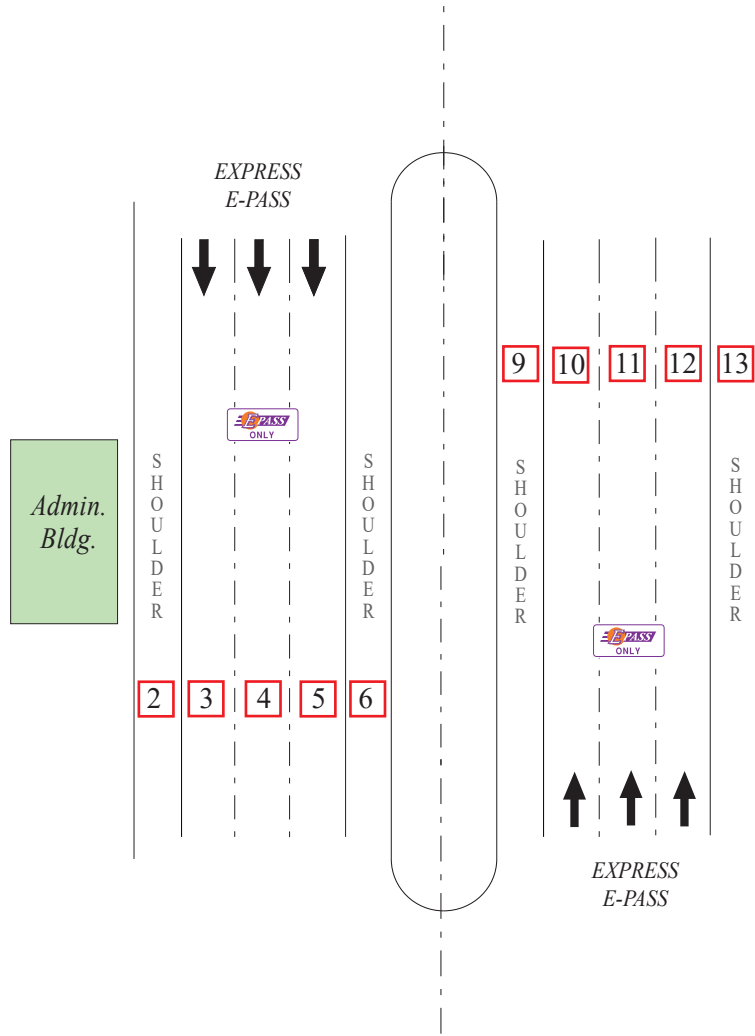

ORG-ID: 22	PID: 435
FACILITY: SR 453 - CORONADO	

LANES OF EQUIPMENT
 6 Express E-PASS (E-PASS only)

T:\OCEA\OCEA MANUAL\STol Facilities Reference Book\2016 Tolls Manual - 3/7/25/16-CP

Beachline Expressway

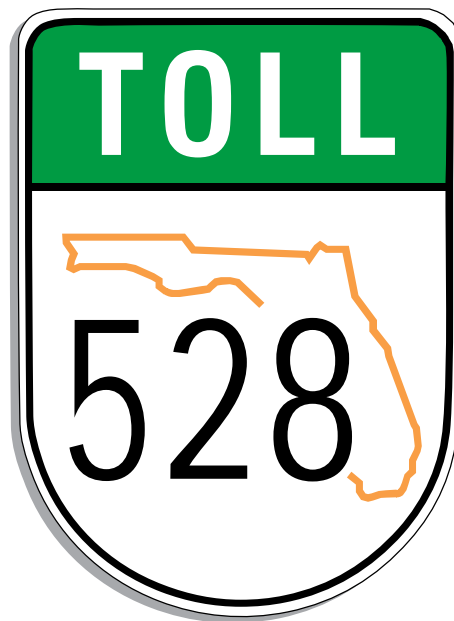

Mainline Toll Plazas and Associated Tolloed Ramps

LEGEND

For Lane Designations for all Plazas

CA - Exact Coin with E-PASS

MA - Change Receipts (Manned) with E-PASS

*ACM - Booth with Manual Lane Terminal,
Automatic Coin Machine and E-PASS*



To SR 520, I-95 &
Port Canaveral

Next Interchange: SR 520
Next Mainline Plaza: None
Next Ramp Plaza: None



Admin.
Blg.

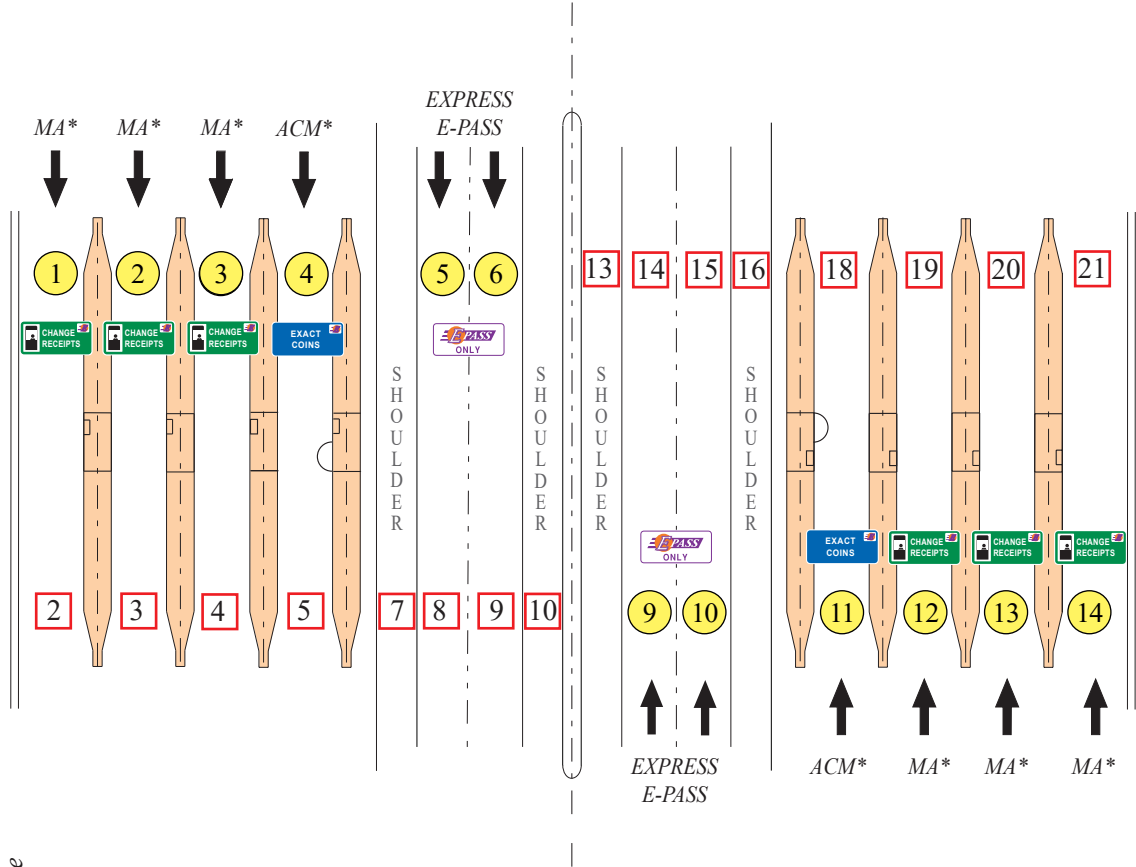

To SR 417 (Greene Way),
SR 436 (Semoran Blvd)
& Orlando Int'l Airport



Next Interchange: Dallas Blvd.
Next Mainline Plaza: Beachline Mainline
Next Ramp Plaza: ICP Blvd.

Note: All Changeable Message Signs (CMS) can display three messages: EXACT COINS, CHANGE RECEIPTS, E-PASS ONLY

ORG-ID: 19	PID: 414
FACILITY: SR 528 - DALLAS	

LANES OF EQUIPMENT

- 6 Manned Booths with E-PASS (MA)
- 2 Booths with ACM's and E-PASS
- 4 Express E-PASS (E-PASS only)
- * Changeable Message Sign

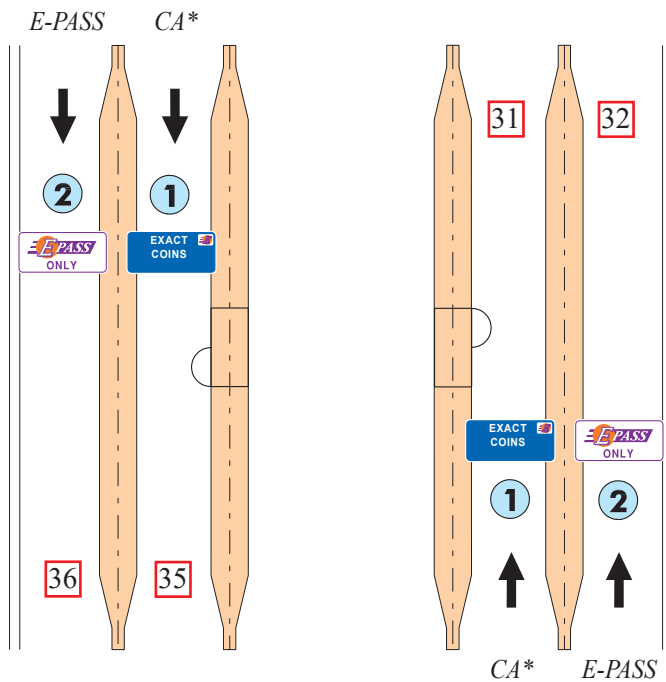
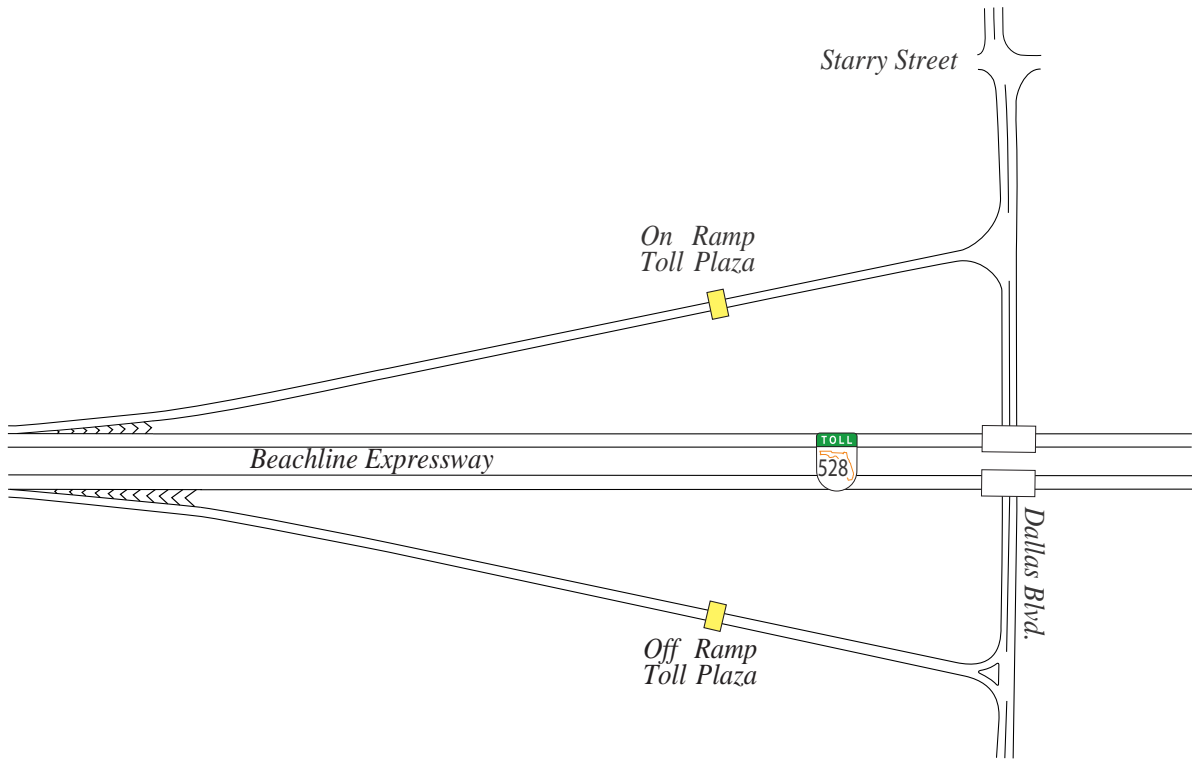

DALLAS
OFF RAMP
R02
PID: 416

DALLAS
ON RAMP
R01
PID: 415

ORG-ID: 19
FACILITY: SR 528 - DALLAS

* Changeable Message Sign

Note: All Changeable Message Signs (CMS) can display three messages: EXACT COINS, CHANGE RECEIPTS, E-PASS ONLY

Reports to Dallas Blvd. Mainline Toll Plaza

T:\OCEA\OCEA MANUAL\STol Facilities Reference Book\2016 Tolls Manual - 3/10/16-CP



To SR 520, I-95 &
Port Canaveral
Next Interchange: ICP Blvd
Next Mainline Plaza: Dallas
Next Ramp Plaza: ICP
EB-ON/WB-OFF

To SR 417 (Greene Way),
SR 436 (Semoran Blvd)
& Orlando Int'l Airport
Next Interchange: SR 417 (Greene Way)
Next Mainline Plaza: Turnpike SR 528 East
Next Ramp Plaza: Conway Rd.

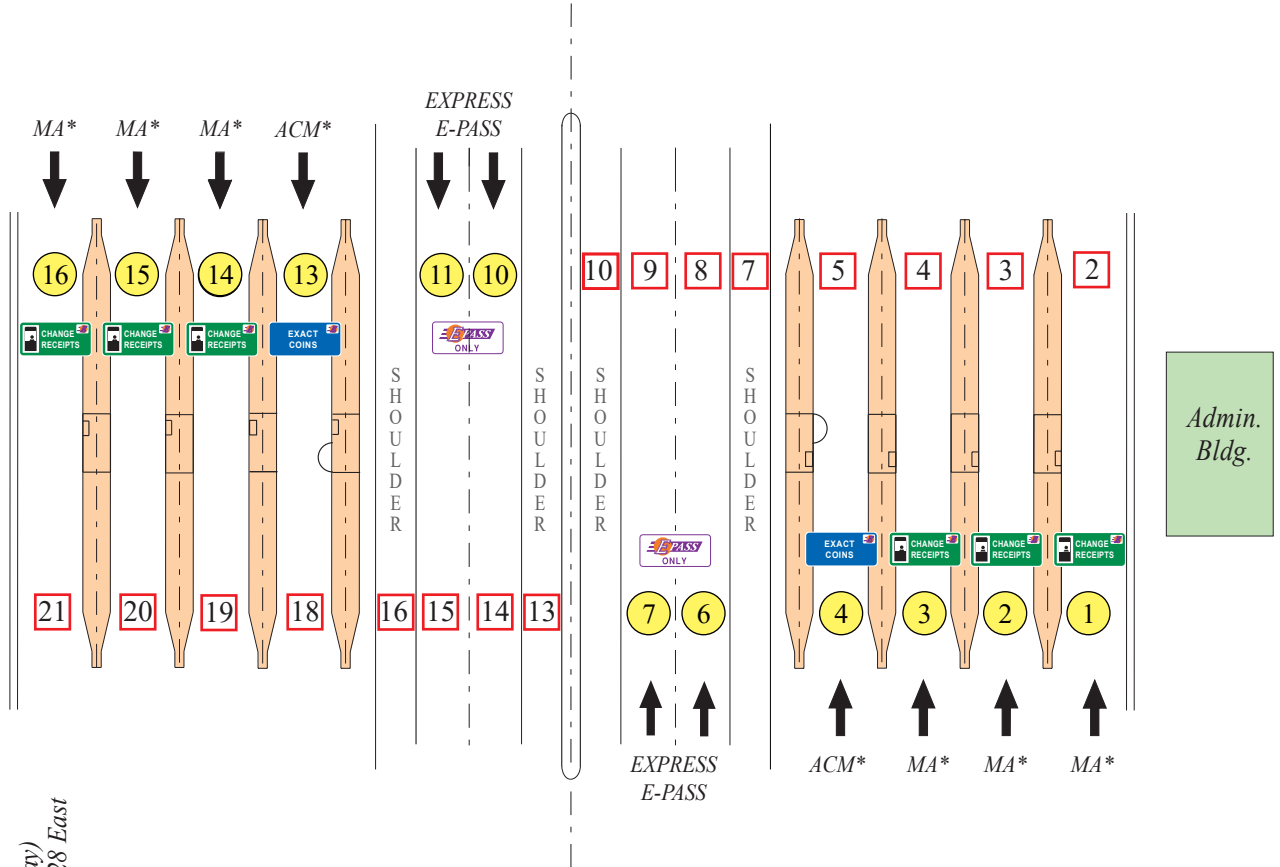

Note: All Changeable Message Signs (CMS) can display three messages: EXACT COINS, CHANGE RECEIPTS, E-PASS ONLY

ORG-ID: 9	PID: 344
FACILITY: SR 528 - BEACHLINE	

LANES OF EQUIPMENT

- 6 Manned Booths with E-PASS (MA)
- 2 Booths with ACM's and E-PASS
- 4 Express E-PASS (E-PASS only)
- * Changeable Message Sign

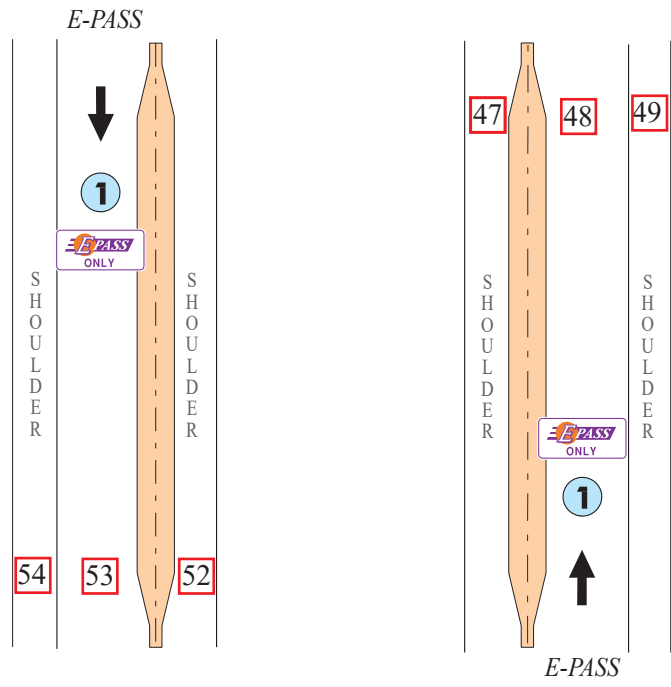
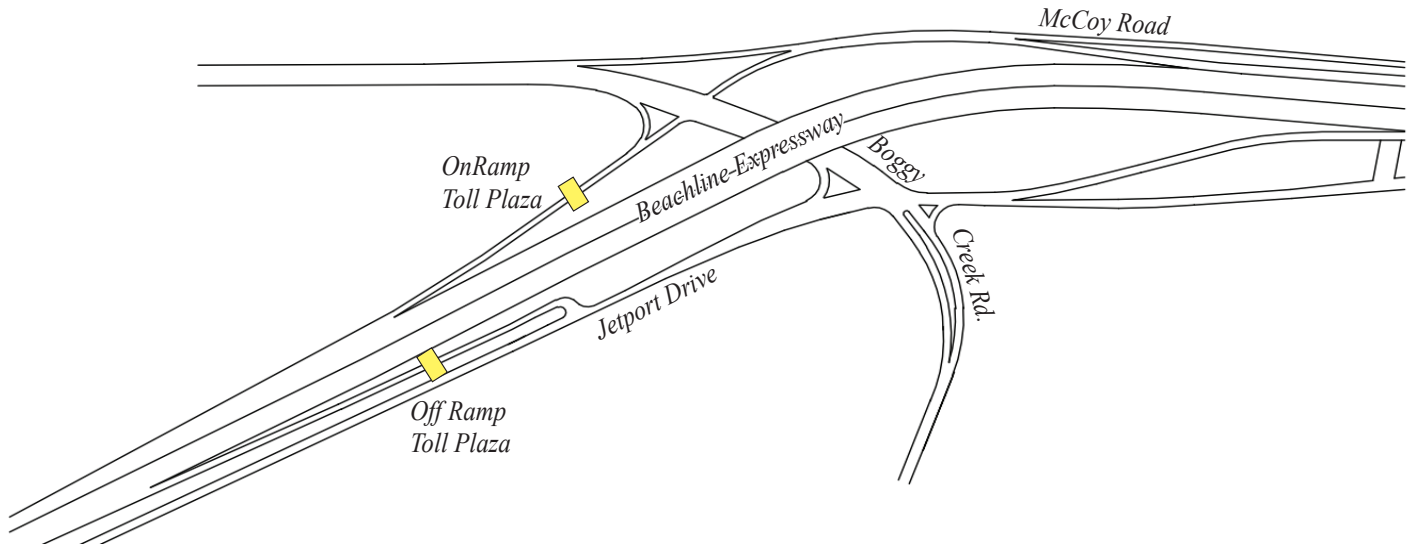

ORG-ID: 9
 FACILITY: SR 528 - BEACHLINE

JETPORT REBATE
OFF RAMP
 R06
 PID: 428

McCOY REBATE
ON RAMP
 R05
 PID: 427

Note: These lanes are Rebate Ramps and will be cross-referenced to determine if a rebate is provided

Reports to Beachline Mainline Toll Plaza

T:\OCEA\OCEA MANUAL\STol Facilities Reference Book\2016 Tolls Manual - 3/10/16-CP

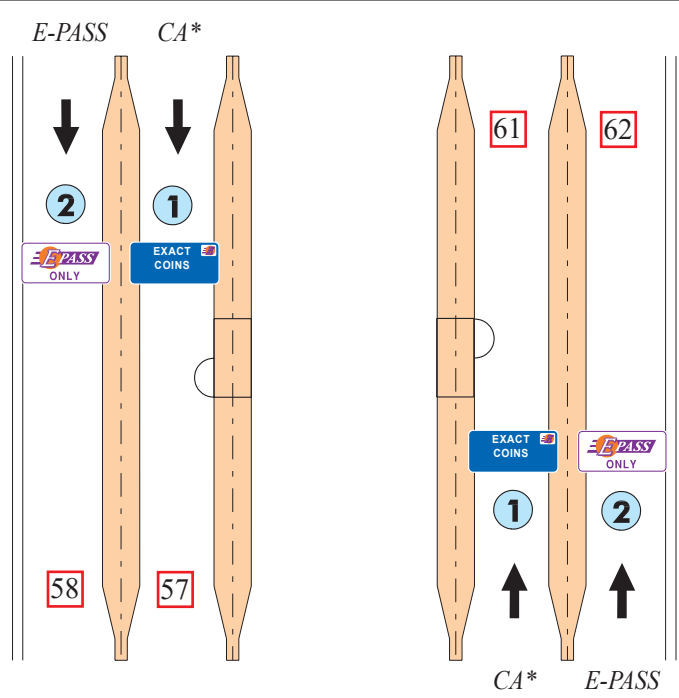
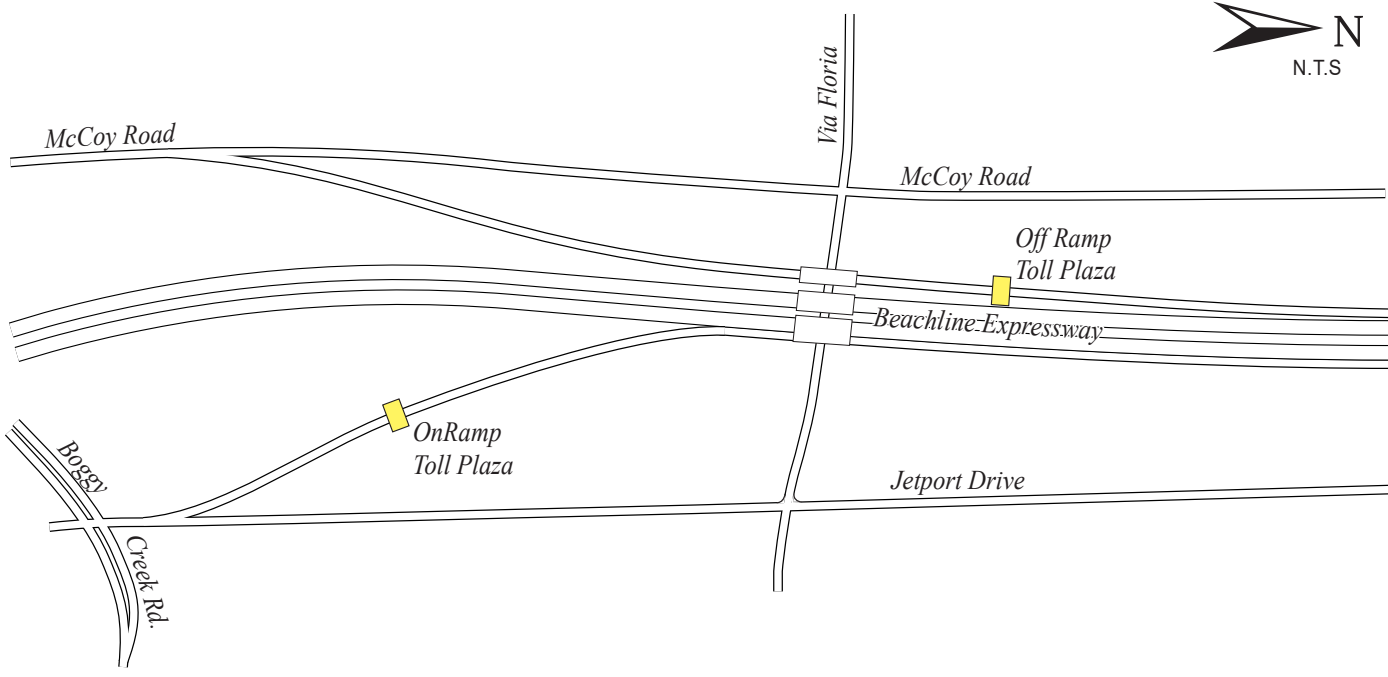

ORG-ID: 9
 FACILITY: SR 528 - BEACHLINE

* Changeable Message Sign

JETPORT DRIVE
 ON RAMP
 R07
 PID: 425

McCOY ROAD
 OFF RAMP
 R08
 PID: 426

Note: All Changeable Message Signs (CMS) can display three messages: EXACT COINS, CHANGE RECEIPTS, E-PASS ONLY

Reports to Beachline Mainline Toll Plaza

T:\DOCEA\DOCEA MANUAL\STol Facilities Reference Book\2016 Tolls Manual - 3/10/16-CP

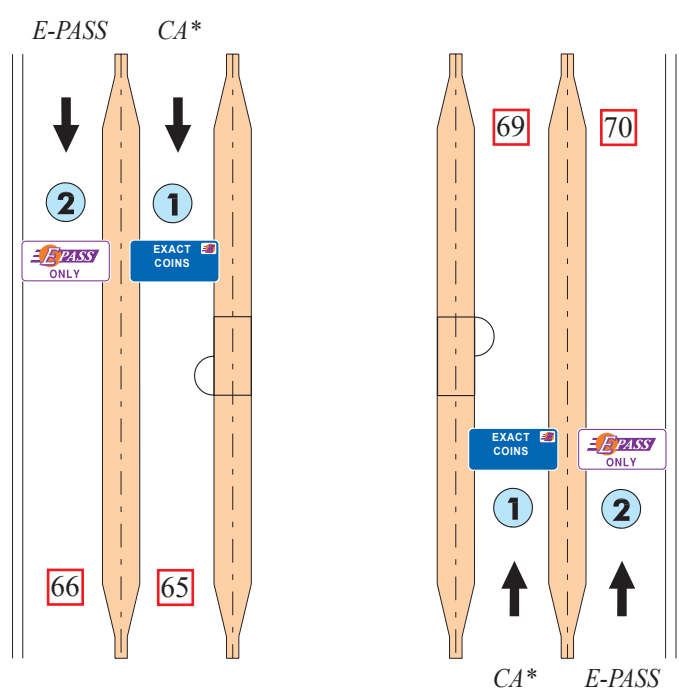
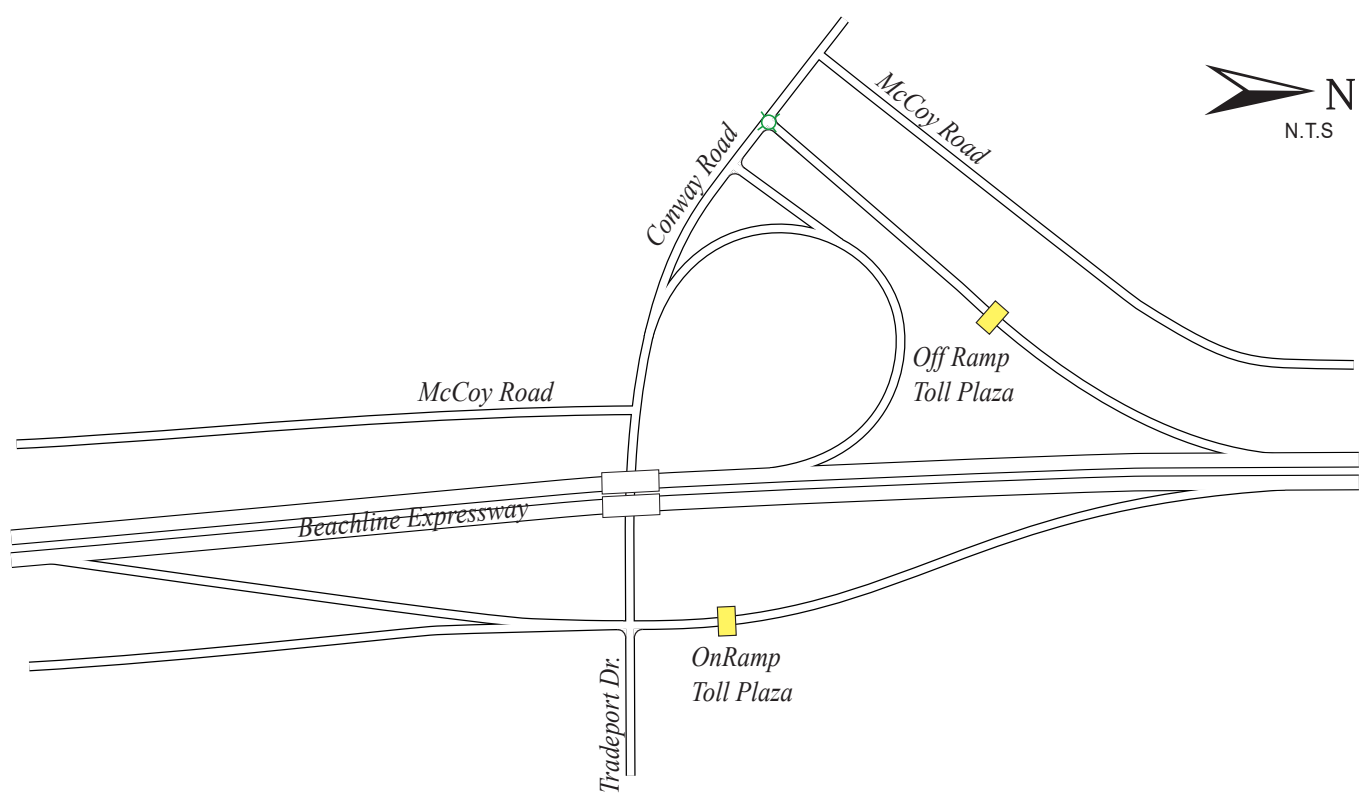

TRADEPORT
ON RAMP
R09
PID: 423

CONWAY
OFF RAMP
R10
PID: 424

ORG-ID: 9
FACILITY: SR 528 - BEACHLINE

* Changeable Message Sign

Note: All Changeable Message Signs (CMS) can display three messages: EXACT COINS, CHANGE RECEIPTS, E-PASS ONLY

Reports to Beachline Mainline Toll Plaza

T:\OCEA\OCEA MANUAL\STol Facilities Reference Book\2016 Tolls Manual - 3/10/16-CP

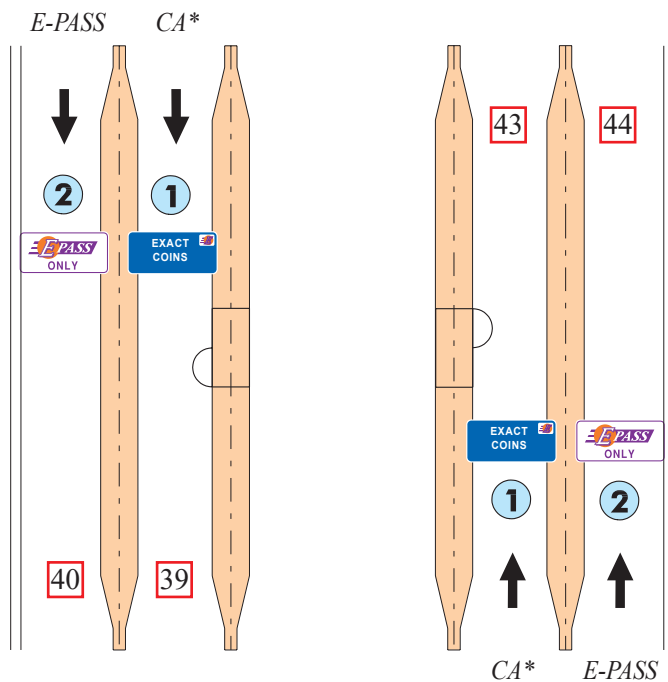
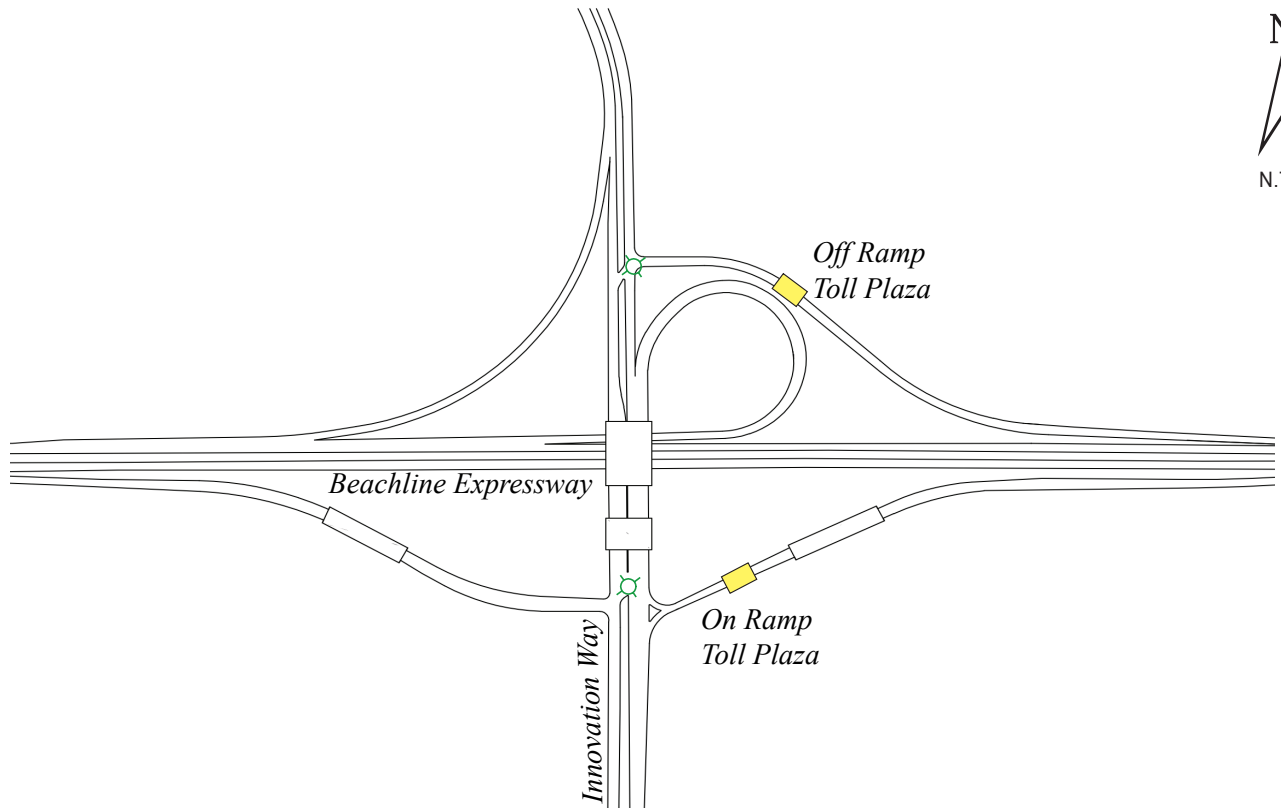

INNOVATION WAY
ON RAMP
R03
PID: 431

INNOVATION WAY
OFF RAMP
R04
PID: 432

ORG-ID: 9
FACILITY: SR 528 - BEACHLINE

* Changeable Message Sign

Note: All Changeable Message Signs (CMS) can display three messages: EXACT COINS, CHANGE RECEIPTS, E-PASS ONLY

Reports to Beachline Mainline Toll Plaza

T:\OCEA\OCEA MANUAL\STol Facilities Reference Book\2016 Tolls Manual - 3/10/16-CP

Poinciana Parkway

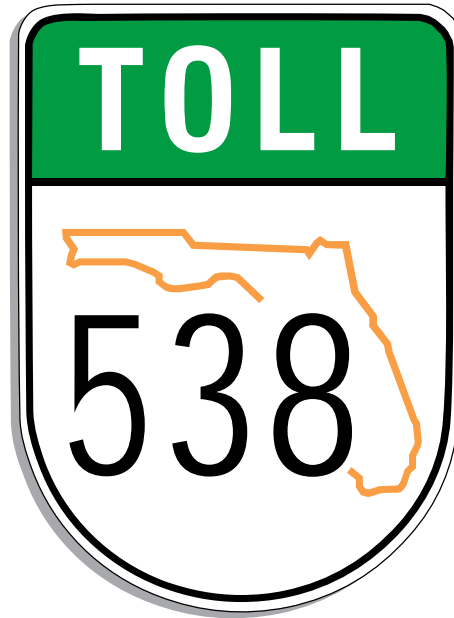

Mainline Toll Plaza

LEGEND

For Lane Designations for all Plazas

AET - Express Lanes



To US 17-92

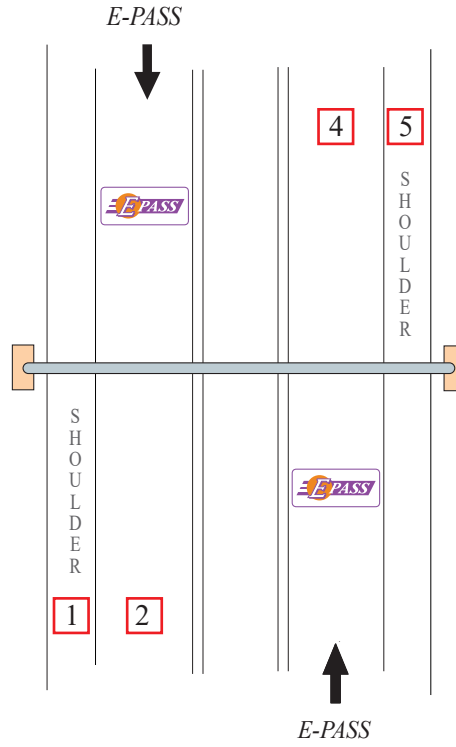

To Marigold Avenue,
Cypress Parkway



ORG-ID: 2	PID: 429
FACILITY: SR 538 - MARIGOLD	

LANES OF EQUIPMENT
 2 Express E-PASS (E-PASS only)

To Marigold Avenue,
US 17-92

To KOA Street,
Cypress Parkway

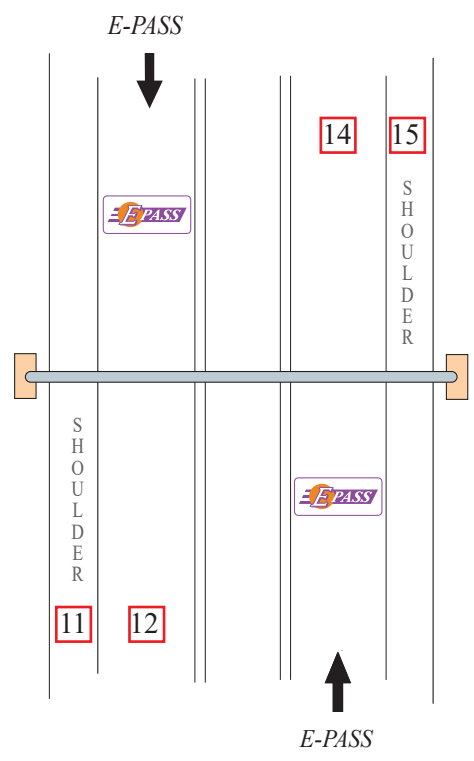

ORG-ID: 2	PID: 430
FACILITY: SR 538 - KOA	

LANES OF EQUIPMENT
 2 Express E-PASS (E-PASS only)

Goldenrod Road Extension

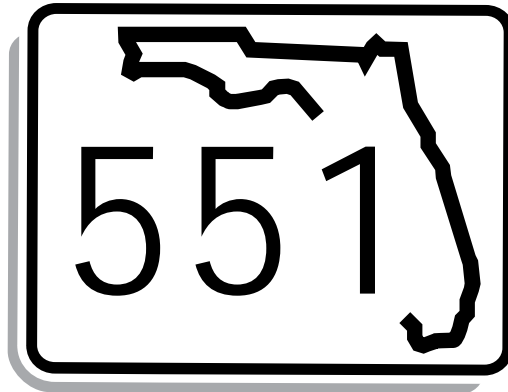

Mainline Toll Plaza

LEGEND

For Lane Designations for all Plazas

CA - Exact Coin with E-PASS

MA - Change Receipts (Manned) with E-PASS

*ACM - Booth with Manual Lane Terminal,
Automatic Coin Machine and E-PASS*



Lee Vista Blvd.
To SR 15 (Hoffner Ave.)
Curry Ford Rd. & SR 408

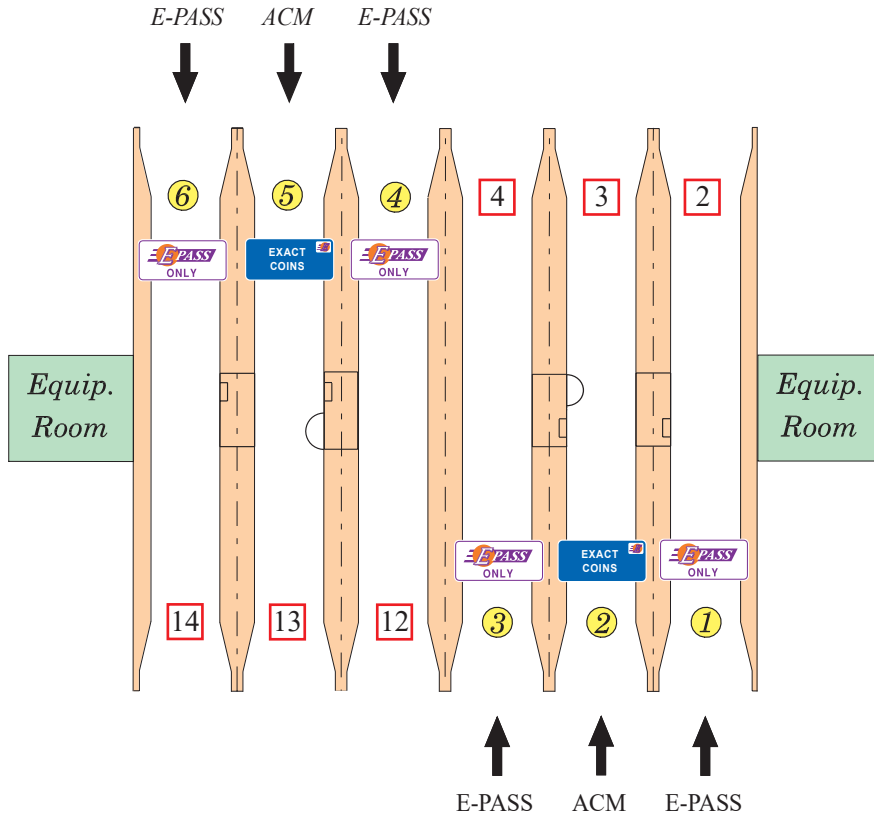

To Orlando International Airport
SR 528 - (Beachline Expressway)



ORG-ID: 18	PID: 349
FACILITY: SR 551 - GOLDENROD	

LANES OF EQUIPMENT

- 2 Automatic Coin Machines with E-PASS (ACM)
- 4 Dedicated E-PASS (E-PASS only)

Note: All Changeable Message Signs (CMS) can display three messages: EXACT COINS, CHANGE RECEIPTS, E-PASS ONLY

Reports to Curry Ford Mainline Toll Plaza

Osceola Parkway

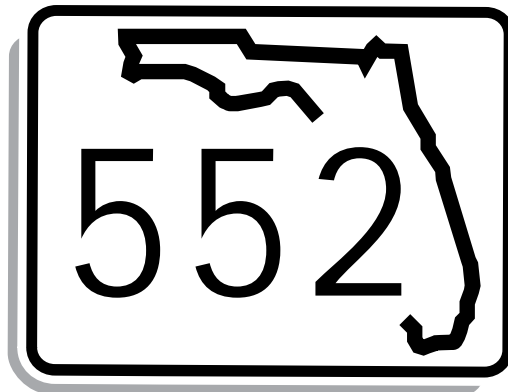

Mainline Toll Plaza and Associated Tolloed Ramps

LEGEND

For Lane Designations for all Plazas

CA - Exact Coin with E-PASS

MA - Change Receipts (Manned) with E-PASS

*ACM - Booth with Manual Lane Terminal,
Automatic Coin Machine and E-PASS*

To SR 417,
I-4 / Disney World

To US 441,
Florida's Turnpike

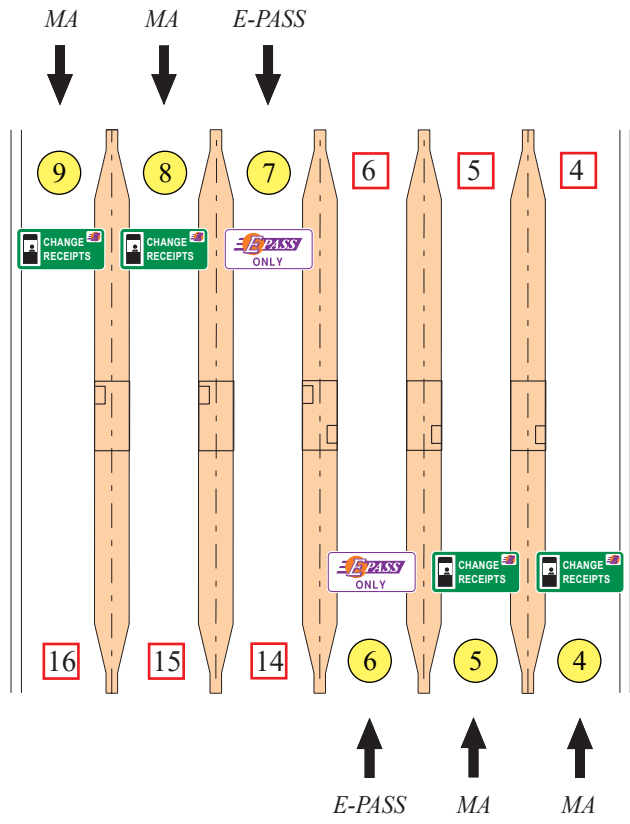

ORG-ID: 17	PID: 350
FACILITY: SR552 - Shingle Creek	

LANES OF EQUIPMENT
 4 Manned Booths with E-PASS (MA)
 2 Booths with E-PASS

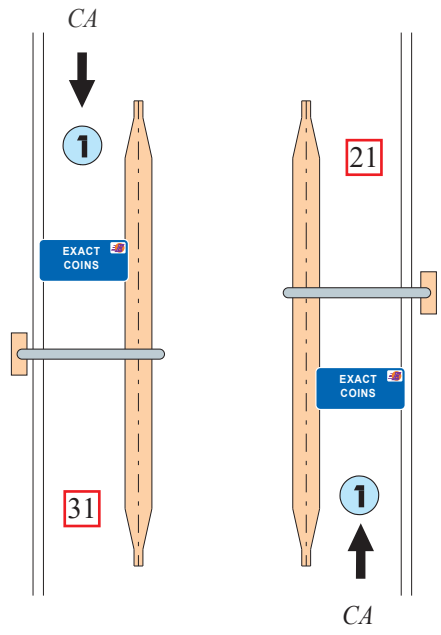
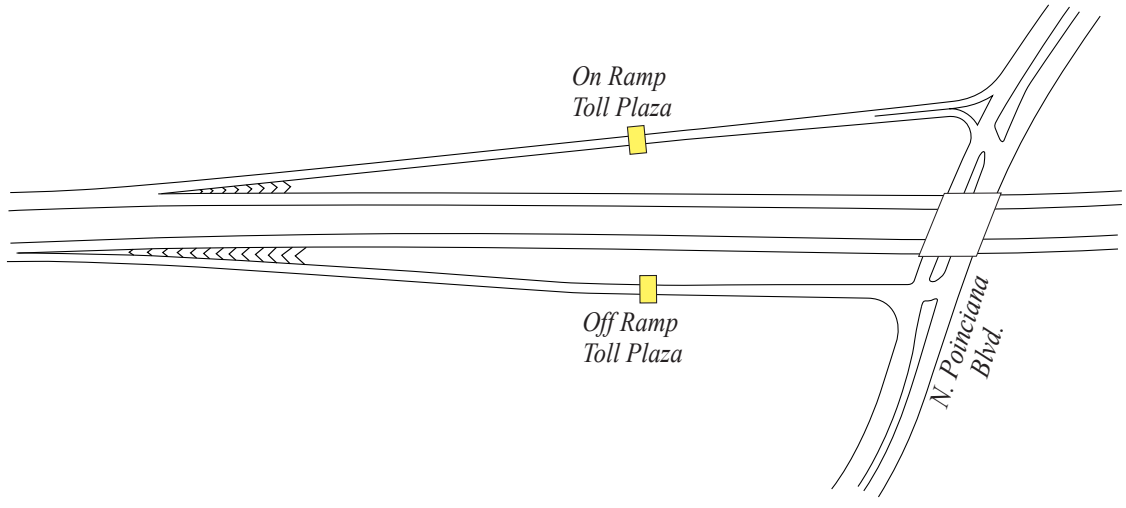

ORG-ID: 17
FACILITY: CR522 - Shingle Creek

POINCIANA
OFF RAMP
R02
PID: 352

POINCIANA
ON RAMP
R01
PID: 351

Reports to Shingle Creek Mainline Toll Plaza

T:\OCEA\OCEA MANUAL\STol Facilities Reference Book\2016 Tolls Manual - 6/28/16-CP