

# Toll Facilities Reference Manual



**CENTRAL  
FLORIDA  
EXPRESSWAY  
AUTHORITY**

UPDATE MARCH 2016

# TABLE OF CONTENTS

	<u>Page(s)</u>
Overview.....	1
Key Addresses and Telephone Numbers .....	1
E-PASS Service Centers.....	1
Mainline Toll Plaza Information.....	2-4
Toll Plaza Location Map .....	5
Toll Rate Summary.....	6
SR 408 - Mainline Toll Plazas and Associated Tolled Ramps .....	7-25
SR 414 - Mainline Toll Plazas and Associated Tolled Ramps .....	26-29
SR 417 - Mainline Toll Plazas and Associated Tolled Ramps .....	30-46
SR 429 - Mainline Toll Plazas and Associated Tolled Ramps .....	47-55
SR 528 - Mainline Toll Plazas and Associated Tolled Ramps .....	56-62
Goldenrod Mainline Toll Plaza.....	63-64

# Central Florida Expressway Authority Toll Facilities Reference Manual

## Overview

This Toll Facilities Reference Manual provides pertinent information in a condensed format relevant to the toll plazas on the Central Florida Expressway System.

## Key Addresses & Telephone Numbers

The addresses and telephone numbers for the Central Florida Expressway Authority and the two (2) E-PASS Service Centers are provided below. In addition, the person in charge at each Mainline Toll Plaza, address for power supply, and the corresponding telephone number are listed. ***Please note that the information shown for the mainline plazas is for official business only.***

Central Florida Expressway Authority  
4974 ORL Tower Road  
Orlando, FL 32807  
407-690-5000  
[www.cfxway.com](http://www.cfxway.com)

## E-PASS Service Centers

Orlando East Service Center  
762 S. Goldenrod Road  
Orlando, FL 32822

Orlando West Service Center  
8919 W. Colonial Drive  
Ocoee, FL 34761

Hours of Operation: 8:00 a.m. to 6:00 p.m. Monday through Friday  
9:00 a.m. to 1:00 p.m. Saturday

E-PASS Service Centers Phone Number: (407) 823-EPASS (823-7277) or 1-800-353-7277

## Mainline Toll Plaza Information



### SR 408 (East West Expressway)

Hiawasse Mainline Toll Plaza  
8302 East West Expwy Hiawasse Main Plaza  
Orlando, FL 32835  
Plaza Manager: Axle Ramos  
Plaza Phone Number: (407) 690-5720



### SR 408 (East West Expressway)

Pine Hills Mainline Toll Plaza  
4700 East West Expwy Pine Hills Main Plaza  
Orlando, FL 32805  
Plaza Manager: Manuela Pena  
Plaza Phone Number: (407) 690-5782



### SR 408 (East West Expressway)

Conway West Mainline Toll Plaza  
4901 SR 408 (East West Expwy) Main Plaza  
Orlando, FL 32807  
Plaza Manager: Emily Burke  
Plaza Phone Number: (407) 690-5708



### SR 408 (East West Expressway)

Conway East Mainline Toll Plaza  
5320 SR 408 (East West Expwy) Main Plaza  
Orlando, FL 32807  
Plaza Manager: Emily Burke  
Plaza Phone Number: (407) 690-5792



### SR 408 (East West Expressway)

Dean Mainline Toll Plaza  
10500 East West Expwy Dean Main Plaza  
Orlando, FL 32825  
Plaza Manager: Deborah Mosteller  
Plaza Phone Number: (407) 690-5715



### SR 414 (Apopka Expressway)

Coral Hills Mainline Toll Plaza  
2401 State Road 414  
Apopka, FL 32825  
Plaza Manager: John John  
Plaza Phone Number: (407) 690-5801

## Mainline Toll Plaza Information



### SR 417 (Central Florida GreeneWay)

John Young Parkway Mainline Toll Plaza

14200 GreeneWay

Orlando, FL 32821

Plaza Manager: Karen Shrewsberry

Plaza Phone Number: (407) 690-5731



### SR 417 (Central Florida GreeneWay)

Boggy Creek Mainline Toll Plaza

13700 GreeneWay

Orlando, FL 32807

Plaza Manager: Karen Shrewsberry

Plaza Phone Number: (407) 690-5738



### SR 417 (Central Florida GreeneWay)

Curry Ford Mainline Toll Plaza

5300 GreeneWay

Orlando, FL 32829

Plaza Manager: Marvin Proska

Plaza Phone Number: (407) 690-5728



### SR 417 (Central Florida GreeneWay)

University Mainline Toll Plaza

2600 GreeneWay

Orlando, FL 32817

Plaza Manager: Maria Torres

Plaza Phone Number: (407) 690-5701



### SR 429 (Western Beltway)

Forest Lake Mainline Toll Plaza

3170 N. SR 429

Ocoee, FL 34761

Plaza Manager: David Frazier, Jr.

Plaza Phone Number: (407) 690-5767



### SR 429 (Western Beltway)

Independence Mainline Toll Plaza

4002 SR 429

Winter Garden, FL 34787

Plaza Manager: David Frazier, Jr.

Plaza Phone Number: (407) 690-5775

## Mainline Toll Plaza Information



### SR 528 (Beachline Expressway)

Dallas Mainline Toll Plaza

12799 S.R. 528

Orlando, FL 32833

Plaza Manager: Eric Veale

Plaza Phone Number: (407) 690-5814



### SR 528 (Beachline Expressway)

Beachline Mainline Toll Plaza

12500 Beachline Expressway

Orlando, FL 32832

Plaza Manager: Sandy Lumseyfai

Plaza Phone Number: (407) 690-5744

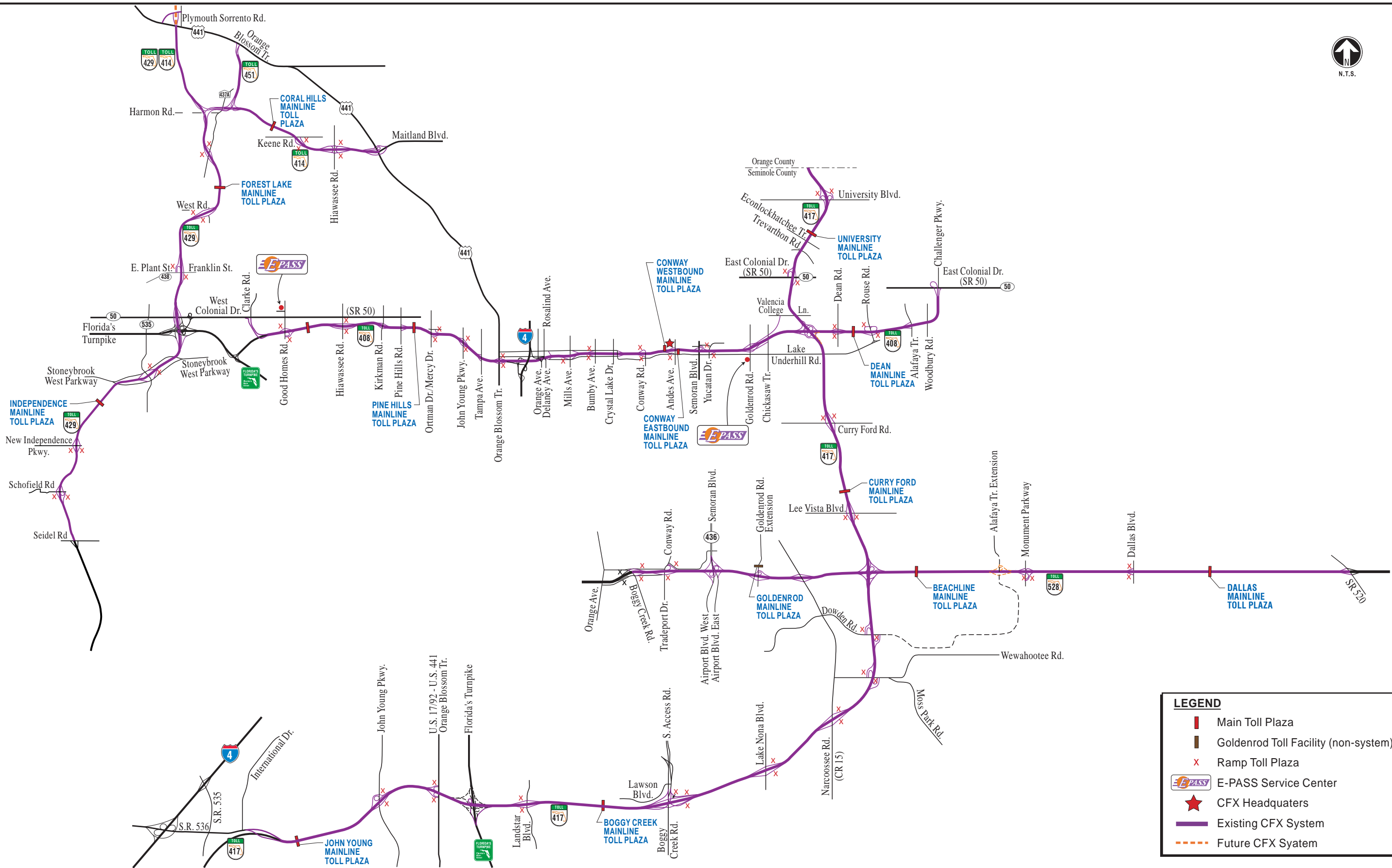

**LEGEND**

- Main Toll Plaza
- Ramp Toll Plaza
- E-PASS Service Center
- CFX Headquarters
- Existing CFX System
- Future CFX System

T:\OCEA\OCEA MANUALS\Toll Facilities Reference Book\2016 Tolls Manual - 2/18/16 CP

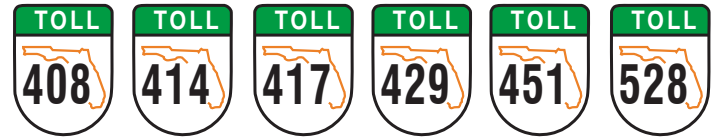

**TOLL PLAZA LOCATION MAP  
CFX Expressway System**

**Central Florida Expressway Authority (CFX)**  
**E-PASS & CASH Toll Rate Summary Per Number of Vehicle Axles as of February 2016**

CFX Expressway	Motorcycle & 2 Axles		3 Axles		4 Axles		5 or More Axles	
	E-PASS	CASH	E-PASS	CASH	E-PASS	CASH	E-PASS	CASH
<b>SR 408 (East West Expressway)</b>								
Hiwassee Mainline Toll Plaza	\$0.82	\$1.00	\$1.64	\$1.75	\$1.91	\$2.00	\$2.46	\$2.50
Good Homes Road	\$0.28	\$0.50	\$0.28	\$0.50	\$0.28	\$0.50	\$0.28	\$0.50
Hiwassee Road	\$0.55	\$0.75	\$0.55	\$0.75	\$0.55	\$0.75	\$0.55	\$0.75
Pine Hills Mainline Toll Plaza	\$1.09	\$1.25	\$1.64	\$1.75	\$1.91	\$2.00	\$2.46	\$2.50
Old Winter Garden Road/Ortman Dr	\$0.82	\$1.00	\$0.82	\$1.00	\$0.82	\$1.00	\$0.82	\$1.00
John Young Parkway	\$0.82	\$1.00	\$0.82	\$1.00	\$0.82	\$1.00	\$0.82	\$1.00
Orange Blossom Trail	\$0.55	\$0.75	\$0.55	\$0.75	\$0.55	\$0.75	\$0.55	\$0.75
Mills Avenue	\$0.55	\$0.75	\$0.55	\$0.75	\$0.55	\$0.75	\$0.55	\$0.75
Conway East-West Mainline Toll Plaza	\$1.09	\$1.25	\$1.64	\$1.75	\$1.91	\$2.00	\$2.46	\$2.50
Bumby Avenue	\$0.55	\$0.75	\$0.55	\$0.75	\$0.55	\$0.75	\$0.55	\$0.75
Conway Road	\$0.82	\$1.00	\$0.82	\$1.00	\$0.82	\$1.00	\$0.82	\$1.00
Andes Ave/SR 436 (Semoran Blvd)	\$1.09	\$1.25	\$1.09	\$1.25	\$1.09	\$1.25	\$1.09	\$1.25
SR 436 (Semoran Blvd)/Yucatan Dr	\$0.82	\$1.00	\$0.82	\$1.00	\$0.82	\$1.00	\$0.82	\$1.00
Dean Mainline Toll Plaza	\$0.82	\$1.00	\$1.64	\$1.75	\$1.91	\$2.00	\$2.46	\$2.50
Dean Road	\$0.55	\$0.75	\$0.55	\$0.75	\$0.55	\$0.75	\$0.55	\$0.75
Rouse Road	\$0.55	\$0.75	\$0.55	\$0.75	\$0.55	\$0.75	\$0.55	\$0.75
<b>SR 528 (Beachline Expressway)</b>								
Boggy Creek Road/McCoy Road	\$1.09	\$1.25	\$1.09	\$1.25	\$1.09	\$1.25	\$1.09	\$1.25
Conway Road/Tradeport Drive	\$1.09	\$1.25	\$1.09	\$1.25	\$1.09	\$1.25	\$1.09	\$1.25
Beachline Mainline Toll Plaza <sup>(1)</sup>	\$0.87	\$1.00	\$1.71	\$1.75	\$2.00	\$2.00	\$2.55	\$2.75
International Corporate Park Blvd <sup>(1)</sup>	\$0.59	\$0.75	\$0.59	\$0.75	\$0.59	\$0.75	\$0.59	\$0.75
Dallas Mainline Toll Plaza <sup>(2)</sup>	\$0.76	\$1.00	\$1.01	\$1.25	\$1.26	\$1.50	\$1.26	\$1.50
Dallas Boulevard	\$0.50	\$0.50	\$0.50	\$0.50	\$0.50	\$0.50	\$0.50	\$0.50
<b>SR 417 (Central Florida GreeneWay)</b>								
John Young Mainline Toll Plaza	\$1.37	\$1.50	\$1.91	\$2.00	\$2.46	\$2.50	\$3.00	\$3.00
John Young Parkway	\$0.82	\$1.00	\$0.82	\$1.00	\$0.82	\$1.00	\$0.82	\$1.00
Orange Blossom Trail	\$0.55	\$0.75	\$0.55	\$0.75	\$0.55	\$0.75	\$0.55	\$0.75
Landstar Boulevard	\$0.50	\$0.50	\$0.50	\$0.50	\$0.50	\$0.50	\$0.50	\$0.50
Boggy Creek Mainline Toll Plaza	\$1.37	\$1.50	\$1.91	\$2.00	\$2.46	\$2.50	\$3.00	\$3.00
South Access Rd/Int'l Airport	\$1.09	\$1.25	\$1.09	\$1.25	\$1.09	\$1.25	\$1.09	\$1.25
Boggy Creek Road	\$1.09	\$1.25	\$1.09	\$1.25	\$1.09	\$1.25	\$1.09	\$1.25
Lake Nona Boulevard	\$0.82	\$1.00	\$0.82	\$1.00	\$0.82	\$1.00	\$0.82	\$1.00
Narcoossee Road	\$0.82	\$1.00	\$0.82	\$1.00	\$0.82	\$1.00	\$0.82	\$1.00
Moss Park Road	\$0.55	\$0.75	\$0.55	\$0.75	\$0.55	\$0.75	\$0.55	\$0.75
Innovation Way/Dowden Road	\$0.55	\$0.75	\$0.55	\$0.75	\$0.55	\$0.75	\$0.55	\$0.75
Curry Ford Mainline Toll Plaza	\$0.82	\$1.00	\$1.64	\$1.75	\$1.91	\$2.00	\$2.46	\$2.50
Lee Vista Boulevard	\$0.55	\$0.75	\$0.55	\$0.75	\$0.55	\$0.75	\$0.55	\$0.75
Curry Ford Road	\$0.55	\$0.75	\$0.55	\$0.75	\$0.55	\$0.75	\$0.55	\$0.75
University Mainline Toll Plaza	\$0.82	\$1.00	\$1.64	\$1.75	\$1.91	\$2.00	\$2.46	\$2.50
SR 50 (Colonial Drive)	\$0.55	\$0.75	\$0.55	\$0.75	\$0.55	\$0.75	\$0.55	\$0.75
University Boulevard	\$0.55	\$0.75	\$0.55	\$0.75	\$0.55	\$0.75	\$0.55	\$0.75
<b>SR 429 (Western Beltway)</b>								
Forest Lake Mainline Toll Plaza	\$1.37	\$1.50	\$1.91	\$2.00	\$2.46	\$2.50	\$3.00	\$3.00
CR 437A (Ocoee-Apopka Road)	\$0.55	\$0.75	\$0.55	\$0.75	\$0.55	\$0.75	\$0.55	\$0.75
West Road	\$0.82	\$1.00	\$0.82	\$1.00	\$0.82	\$1.00	\$0.82	\$1.00
Plant Street/Franklin Street/SR 438	\$0.28	\$0.50	\$0.28	\$0.50	\$0.28	\$0.50	\$0.28	\$0.50
Independence Mainline Toll Plaza	\$1.37	\$1.50	\$1.91	\$2.00	\$2.46	\$2.50	\$3.00	\$3.00
CR 535	\$0.55	\$0.75	\$0.55	\$0.75	\$0.55	\$0.75	\$0.55	\$0.75
New Independence Parkway	\$0.82	\$1.00	\$0.82	\$1.00	\$0.82	\$1.00	\$0.82	\$1.00
Schofield Road	\$0.55	\$0.75	\$0.55	\$0.75	\$0.55	\$0.75	\$0.55	\$0.75
<b>SR 414 (Apopka Expressway)</b>								
Coral Hills Mainline Toll Plaza	\$1.09	\$1.25	\$1.64	\$1.75	\$2.18	\$2.25	\$2.73	\$2.75
Keene Road	\$0.55	\$0.75	\$0.55	\$0.75	\$0.55	\$0.75	\$0.55	\$0.75
Hiwassee Road	\$0.28	\$0.50	\$0.28	\$0.50	\$0.28	\$0.50	\$0.28	\$0.50
<b>Goldenrod Road Extension - Non System</b>								
Goldenrod Mainline Toll Plaza	\$0.50	\$0.50	\$0.50	\$0.50	\$0.50	\$0.50	\$0.50	\$0.50

Notes:

1. Incremental increase due to the CFX July 2012 toll rate adjustment is applied at the Beachline Main Plaza and ICP Blvd ramps to preserve toll equity along the SR 528.
2. Toll rates shown for the Dallas Mainline Toll Plaza include a \$0.26 EPASS and \$0.50 Cash toll charge regardless of the number of axles that is allocated to the FDOT.



# East-West Expressway

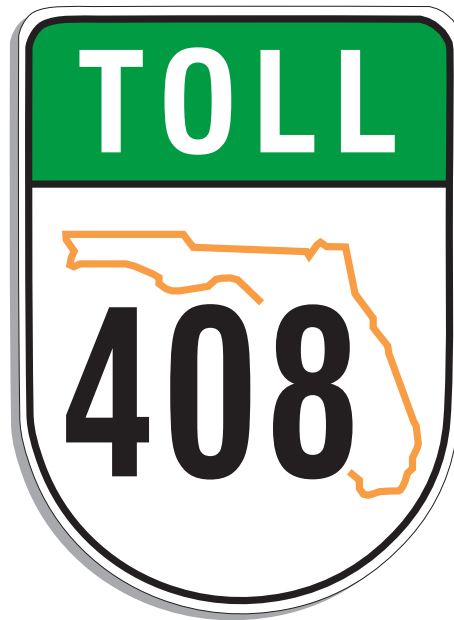

## Mainline Toll Plazas and Associated Tolloed Ramps

### LEGEND

*For Lane Designations for all Plazas*

*CA - Exact Coin with E-PASS*

*MA - Change Receipts (Manned) with E-PASS*

*MCA - Booth with Manual Lane Terminal,  
Automatic Coin Machine and E-PASS*

↑ To I-4 (Downtown Orlando)

Next Interchange: Hiawassee Rd.  
 Next Mainline Plaza: Pine Hills Mainline  
 Next Ramp Plaza: Hiawassee Rd. EB-ON/  
 WB-OFF

↓ To Florida's Turnpike & SR 50

Next Interchange: Good Homes Road

Admin.  
Bldg.

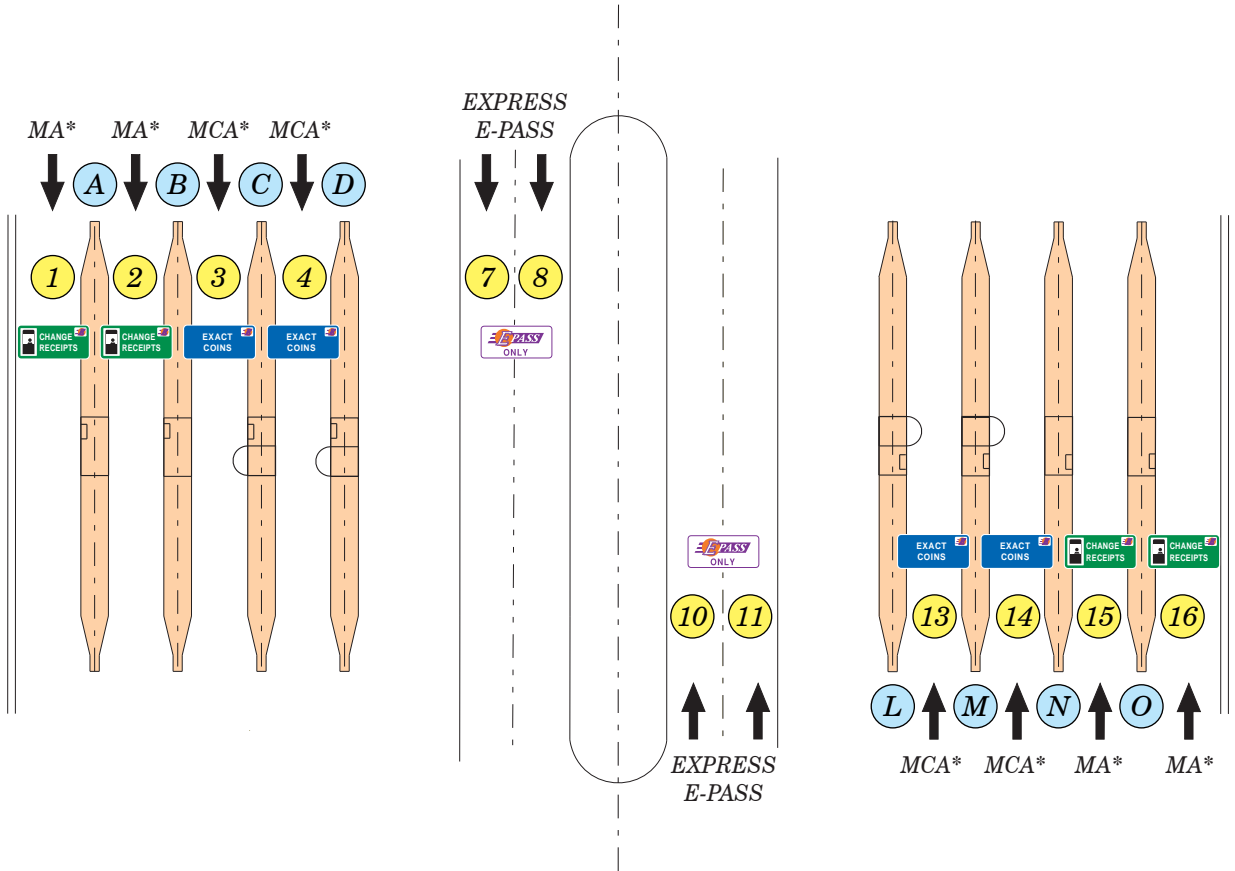

Note: All Changeable Message Signs (CMS) can display three messages: EXACT COINS, CHANGE RECEIPTS, E-PASS ONLY

<u>FARE STRUCTURE</u>		
	<u>Cash</u>	<u>Electronic</u>
2 Axles	\$ 1.00	\$ 0.82
3 Axles	\$ 1.75	\$ 1.64
4 Axles	\$ 2.00	\$ 1.91
5 Axles or more	\$ 2.50	\$ 2.46

LANES OF EQUIPMENT

- 4 Manned Booth with E-PASS (MA)
- 2 Booths with Automatic Coin Machines with E-PASS (MCA)
- 4 Express E-PASS (E-PASS only)
- \* Changeable Message Sign

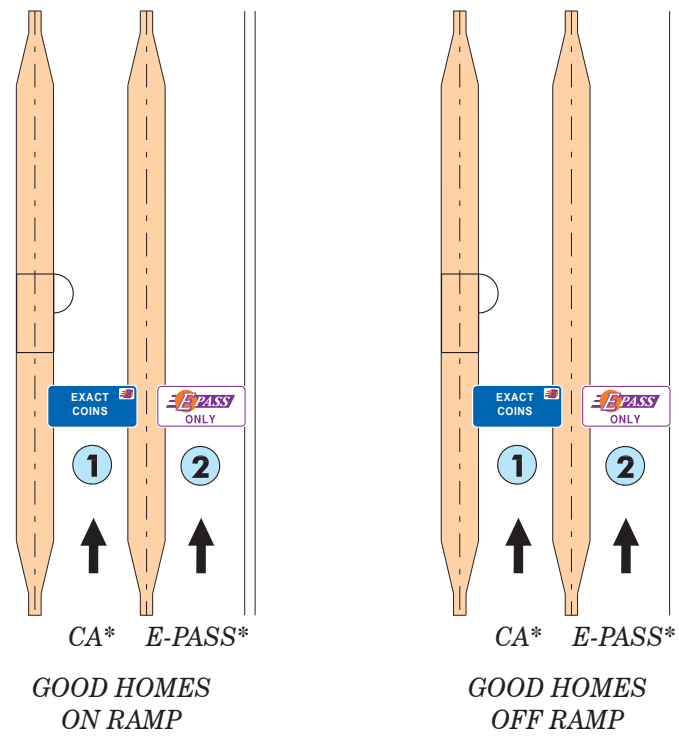
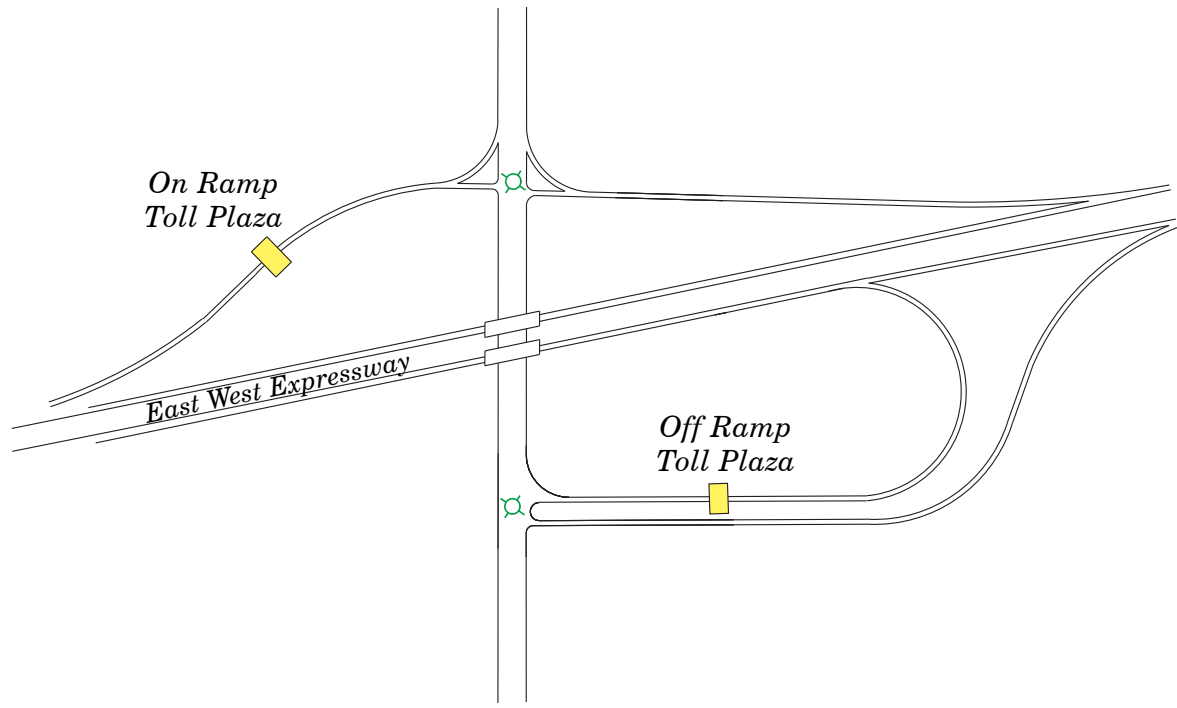

FARE STRUCTURE ALL VEHICLES	
Cash	Electronic
\$ 0.50	\$ 0.28

\* Changeable Message Sign

Note: All Changeable Message Signs (CMS) can display three messages: EXACT COINS, CHANGE RECEIPTS, E-PASS ONLY

Reports to Hiwassee Mainline Toll Plaza

T:\00CEANOCEA MANUAL\ST01\Facilities Reference Book\2016 Toll Manual - 3/10/16-CP

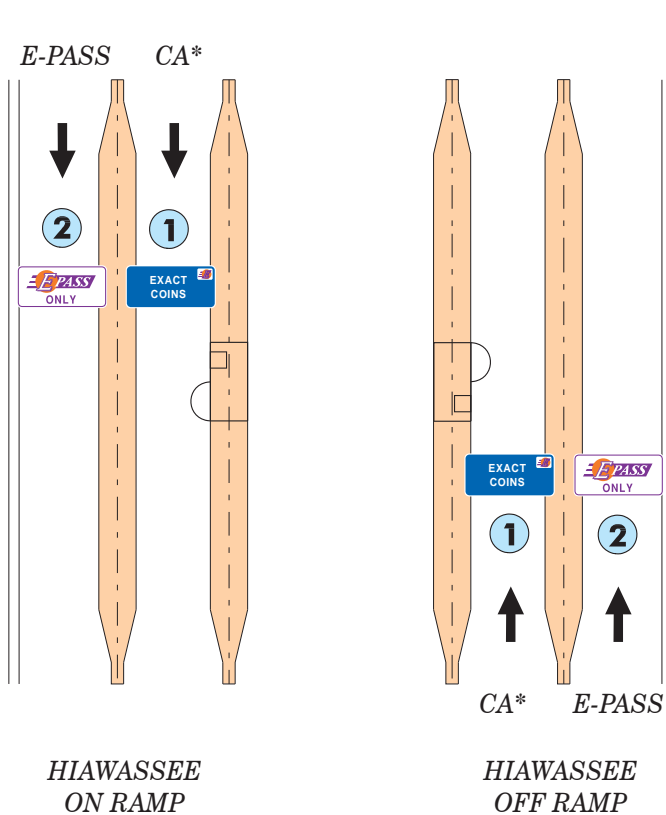
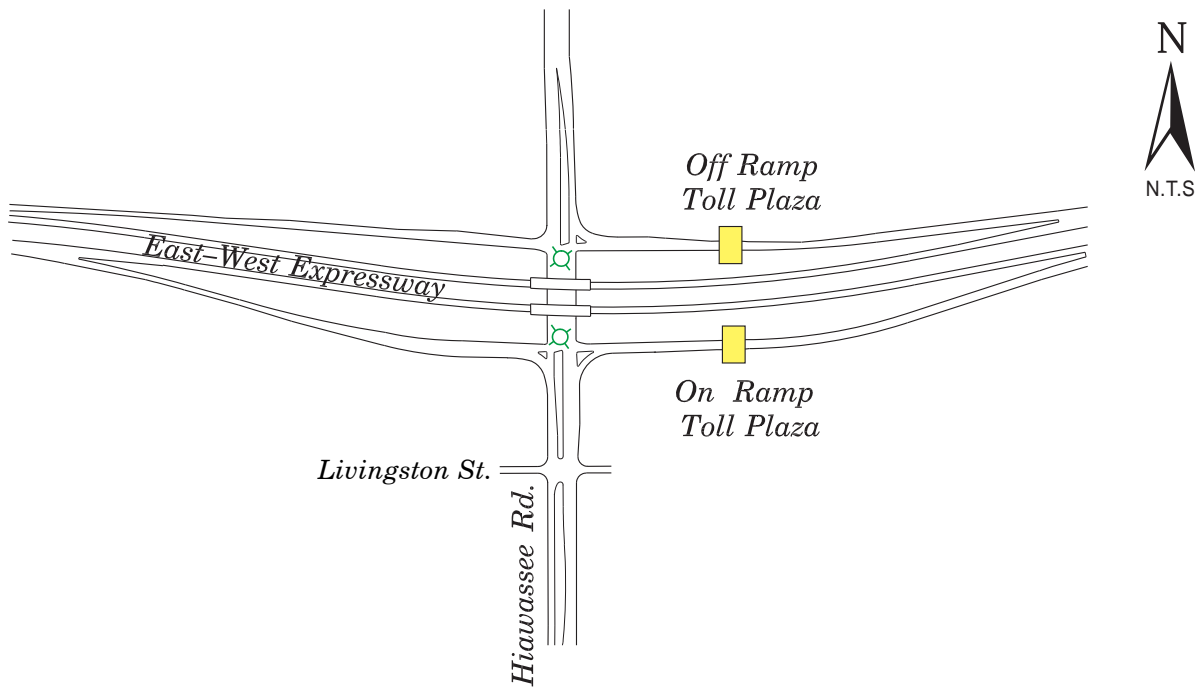

FARE STRUCTURE ALL VEHICLES	
Cash	Electronic
\$ 0.75	\$ 0.55

\* Changeable Message Sign

Note: All Changeable Message Signs (CMS) can display three messages: EXACT COINS, CHANGE RECEIPTS, E-PASS ONLY

Reports to Hiwassee Mainline Toll Plaza

T:\00CEANOCEA MANUAL\ST01\Facilities Reference Book\2016 Toll Manual - 3/10/16-CP



To Florida's Turnpike

Next Interchange: Pine Hills Rd.  
 Next Mainline Plaza: Hiwassee Mainline  
 Next Ramp Plaza: Hiwassee Rd. EB-ON/  
 WB-OFF

Admin.  
Bldg.

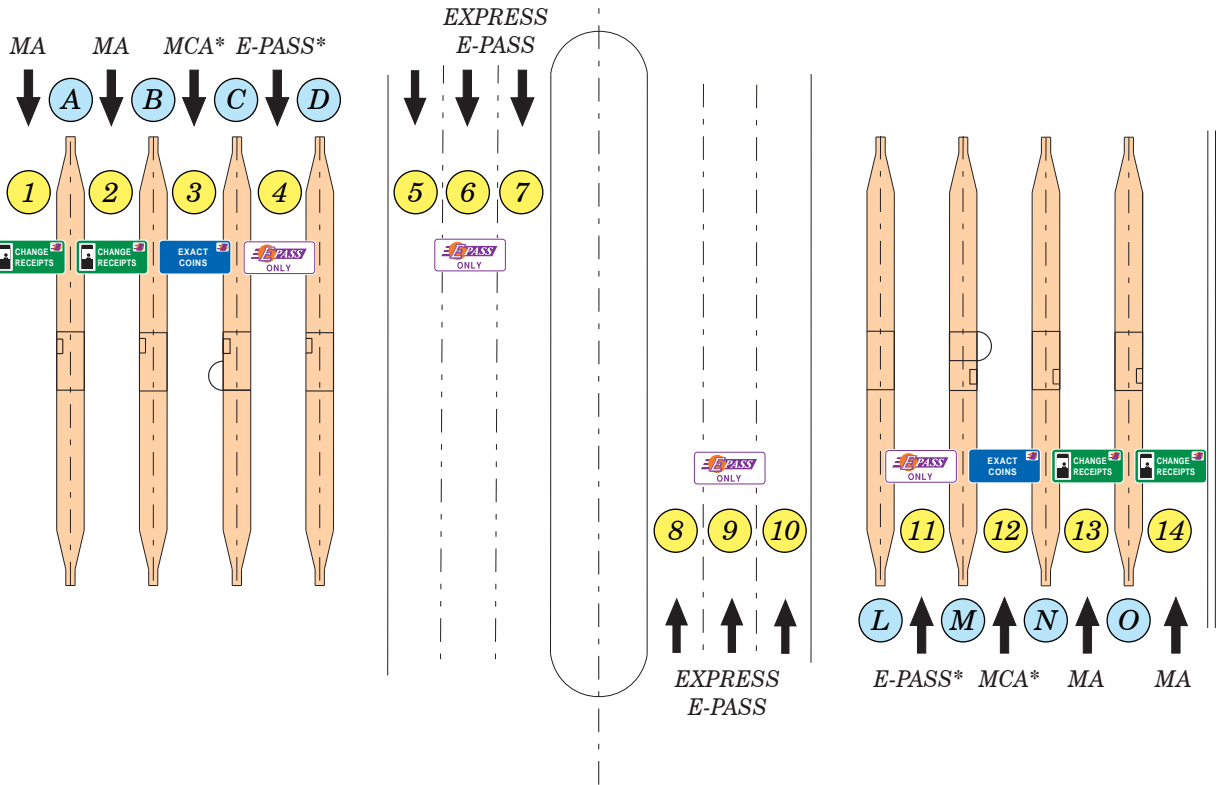

To I-4 (Downtown Orlando)

Next Interchange: John Young Pkwy. (CR 423)  
 Next Mainline Plaza: Conway East & West Mainline  
 Next Ramp Plaza: John Young Pkwy. EB-ON/  
 WB-OFF

Note: All Changeable Message Signs (CMS) can display three messages: EXACT COINS, CHANGE RECEIPTS, E-PASS ONLY

**FARE STRUCTURE**

	Cash	Electronic
2 Axles	\$ 1.25	\$ 1.09
3 Axles	\$ 1.75	\$ 1.64
4 Axles	\$ 2.00	\$ 1.91
5 Axles or more	\$ 2.50	\$ 2.46

**LANES OF EQUIPMENT**

- 4 Manned Booths with E-PASS (MA)
- 2 Booths with Automatic Coin Machines with E-PASS (MCA)
- 2 Booths with E-PASS
- 6 Express E-PASS only

\* Changeable Message Sign

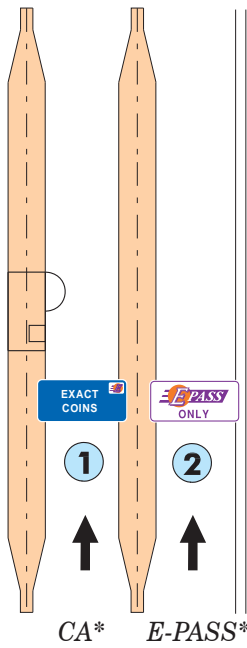
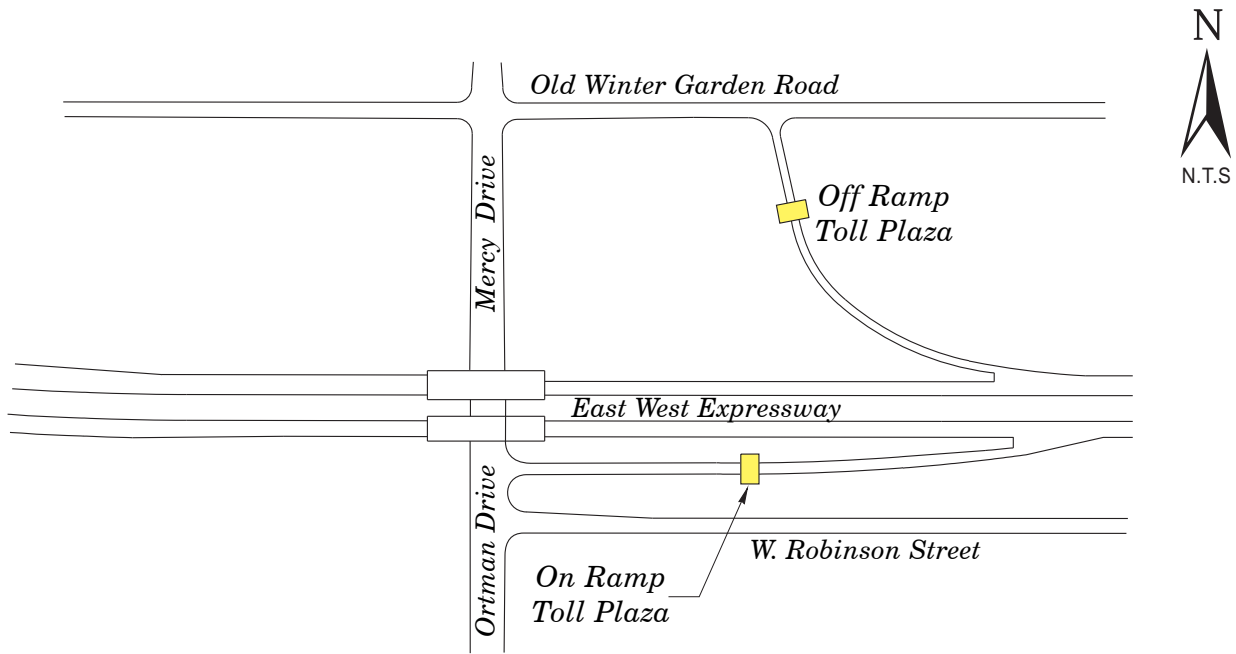

OLD WINTER GARDEN  
OFF RAMP

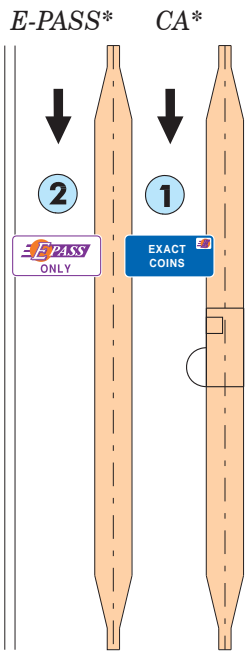

OLD WINTER GARDEN  
ON RAMP



FARE STRUCTURE ALL VEHICLES	
Cash	Electronic
\$ 1.00	\$ 0.82

\* Changeable Message Sign

Note: All Changeable Message Signs (CMS) can display three messages: EXACT COINS, CHANGE RECEIPTS, E-PASS ONLY

Reports to Pine Hills Mainline Toll Plaza

T:\00CEANOCEA MANUAL\ST01 Toll Facilities Reference Book\2016 Toll Manual - 3/10/16-CP

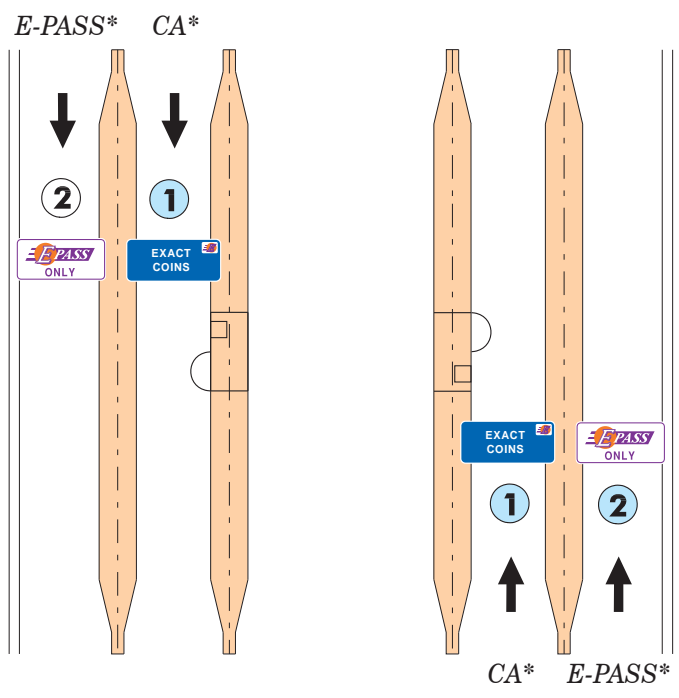
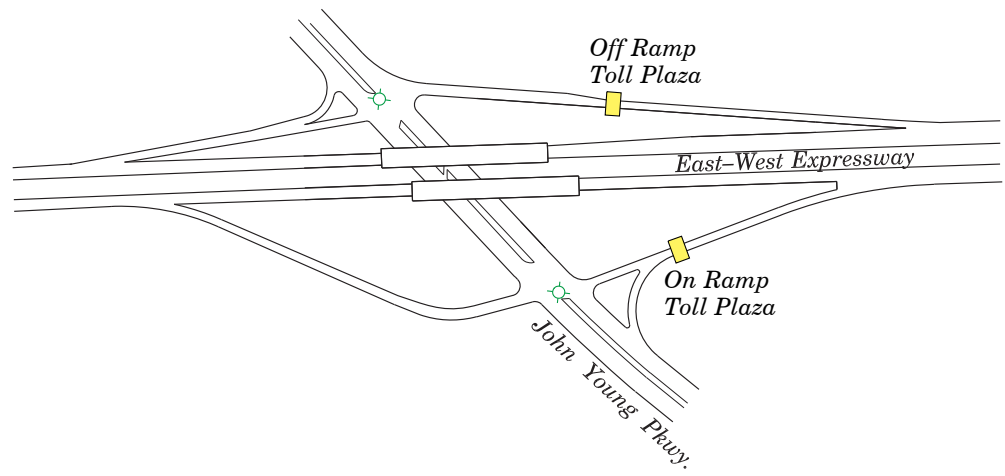

JOHN YOUNG PARKWAY  
ON RAMP

JOHN YOUNG PARKWAY  
OFF RAMP

Reports to Pine Hills Mainline Toll Plaza

FARE STRUCTURE ALL VEHICLES	
Cash	Electronic
\$ 1.00	\$ 0.82

\* Changeable Message Sign

Note: All Changeable Message Signs (CMS) can display three messages: EXACT COINS, CHANGE RECEIPTS, E-PASS ONLY

T:\DOCEANODOCEA MANUAL\STall Facilities Reference Book\2016 Toll Manual - 3/10/16-CP

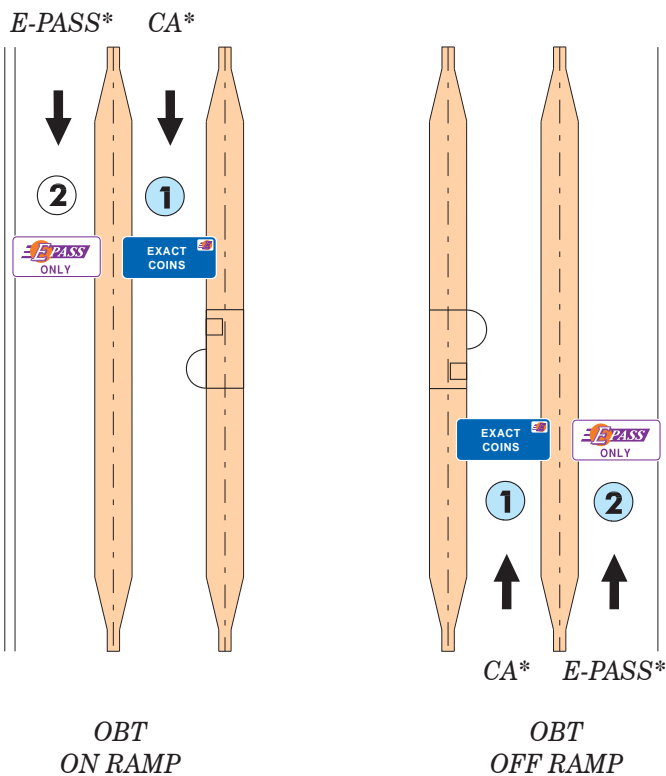
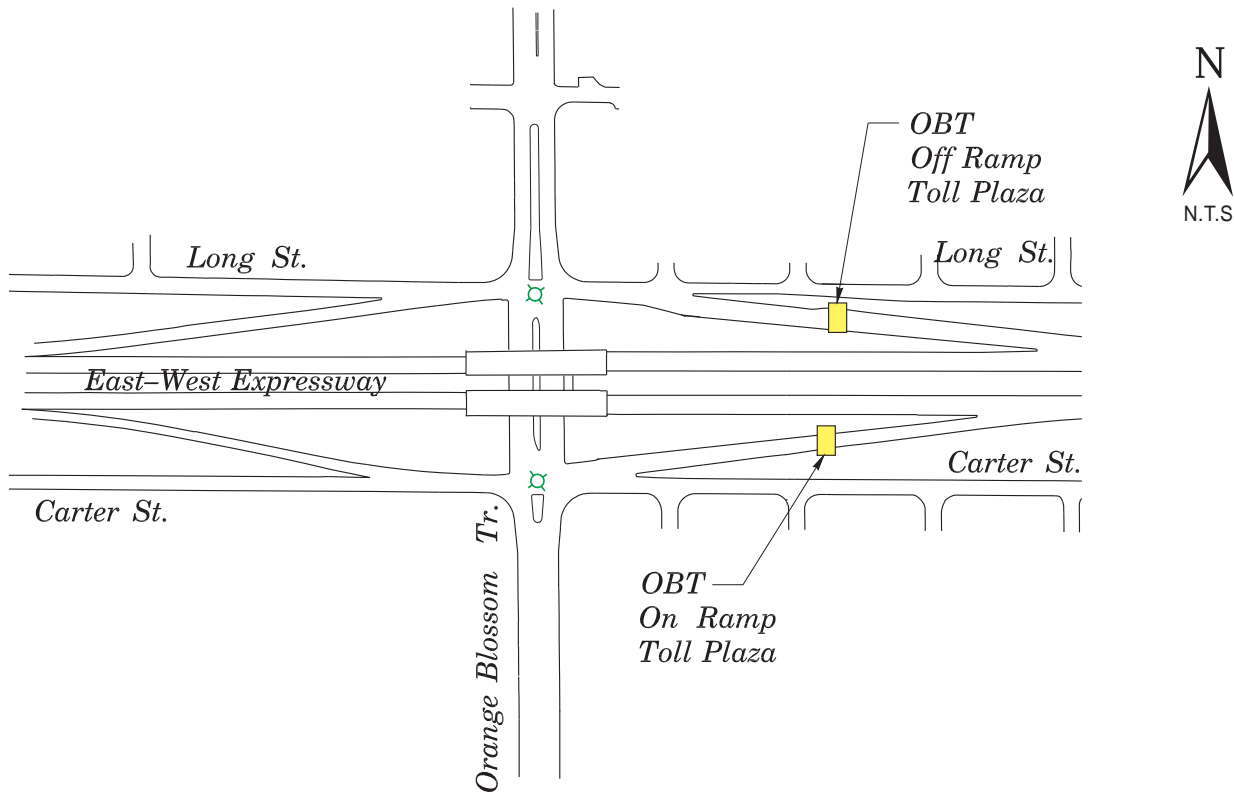

**FARE STRUCTURE  
ALL VEHICLES**

Cash	Electronic
\$ 0.75	\$ 0.55

\* Changeable Message Sign

Note: All Changeable Message Signs (CMS) can display three messages: EXACT COINS, CHANGE RECEIPTS, E-PASS ONLY

Reports to Pines Hills Mainline Toll Plaza

T:\00CEANOCEA MANUAL\ST01 Toll Facilities Reference Book\2016 Toll Manual - 3/10/16-CP



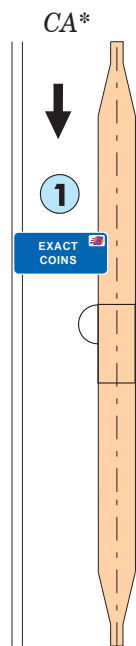
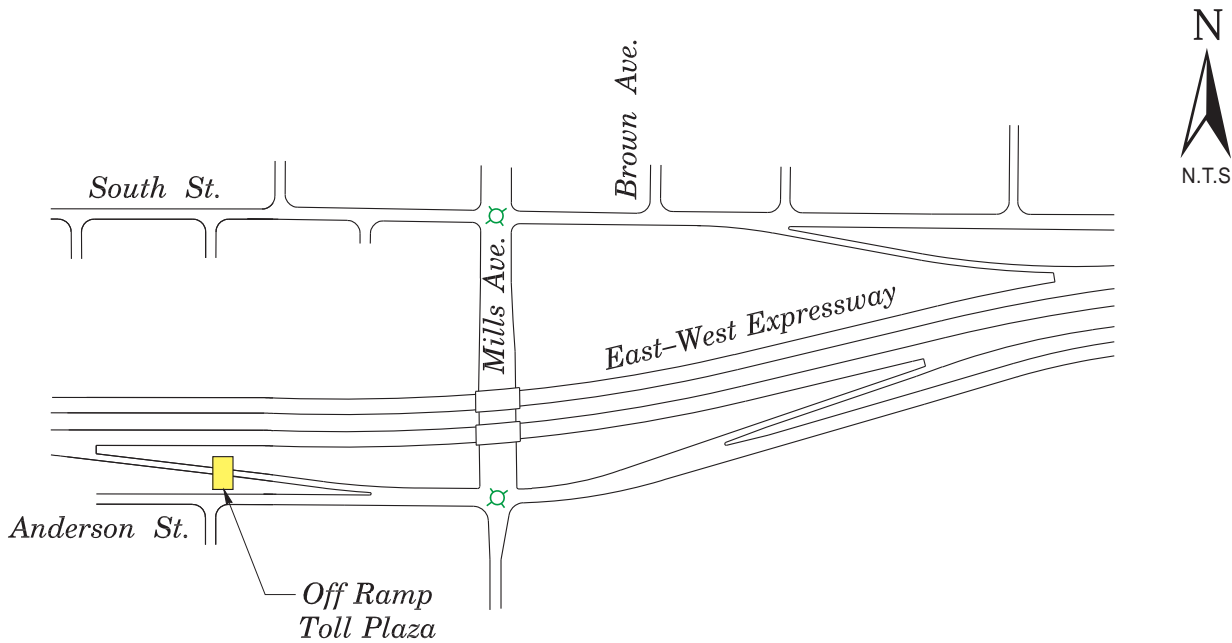

<i>FARE STRUCTURE ALL VEHICLES</i>	
<i>Cash</i>	<i>Electronic</i>
<i>\$ 0.75</i>	<i>\$ 0.55</i>

**MILLS  
OFF RAMP**

*Note: All Changeable Message Signs (CMS) can display three messages: EXACT COINS, CHANGE RECEIPTS, E-PASS ONLY*

*Reports to Pine Hills Mainline Toll Plaza*

T:\00CEANOCEA MANUAL\ST01\Facilities Reference Book\2016 Tolls Manual - 3/10/16-CP



To I-4 (Downtown Orlando)

Next Interchange: Crystal Lake Dr.  
Next Mainline Plaza: Pine Hills Mainline  
Next Ramp Plaza: Orange Blossom Trail  
WB-OFF / EB-ON

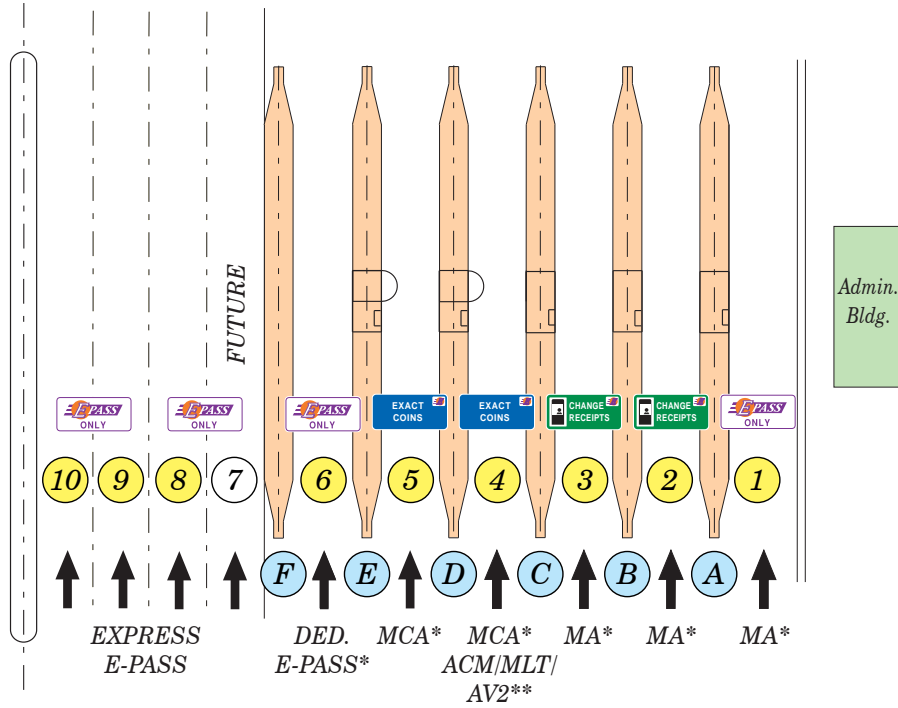

**FARE STRUCTURE**

	<u>Cash</u>	<u>Electronic</u>
2 Axles	\$ 1.25	\$ 1.09
3 Axles	\$ 1.75	\$ 1.64
4 Axles	\$ 2.00	\$ 1.91
5 Axles or more	\$ 2.50	\$ 2.46

- LANES OF EQUIPMENT**
- 3 Manned Booths with E-PASS (MA)
  - 2 Booths with Automatic Coin Machines (MCA) with E-PASS
  - 1 Dedicated E-PASS
  - 3 Express E-PASS (E-PASS only)
  - \* Changeable Message Sign

\*\* Peak Hour Operates as a Manual Booth

T:\00CEANOCEA MANUAL\ST01\Facilities Reference Book\2016 Tolls Manual - 3/10/16-CP

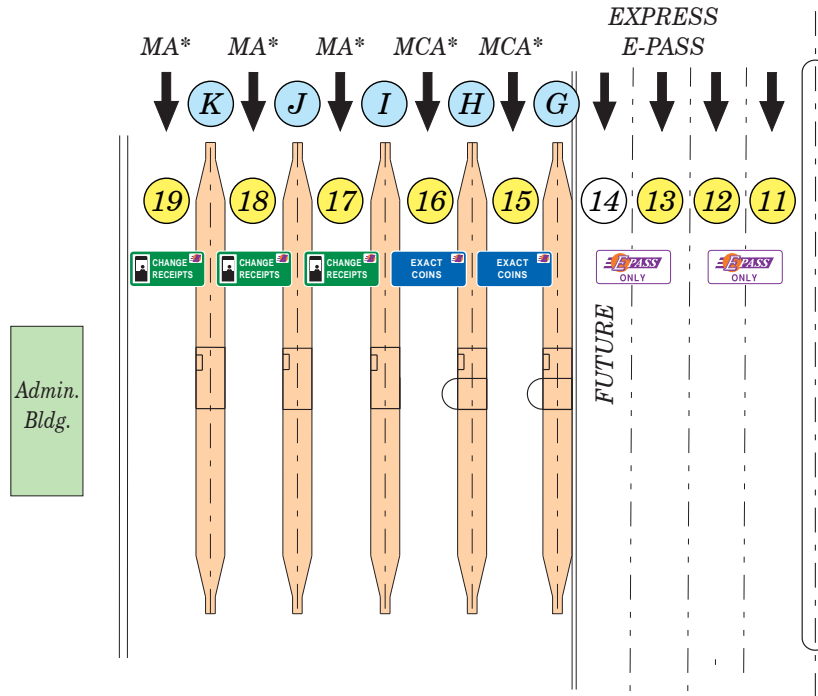

↓ To SR 417 (GreeneWay),  
 UCF & SR 50  
 Next Interchange: SR 551 (Goldenrod Rd.)  
 Next Mainline Plaza: Dean Mainline  
 Next Ramp Plaza: Dean Rd.  
 EB-OFF / WB-ON

<u>FARE STRUCTURE</u>		
	<u>Cash</u>	<u>Electronic</u>
2 Axles	\$ 1.25	\$ 1.09
3 Axles	\$ 1.75	\$ 1.64
4 Axles	\$ 2.00	\$ 1.91
5 Axles or more	\$ 2.50	\$ 2.46

LANES OF EQUIPMENT

- 3 Manned Booths with E-PASS (MA)
- 2 Booths with Automatic Coin Machines (MCA) with E-PASS
- 3 Express E-PASS (E-PASS only)
- \* Changeable Message Sign

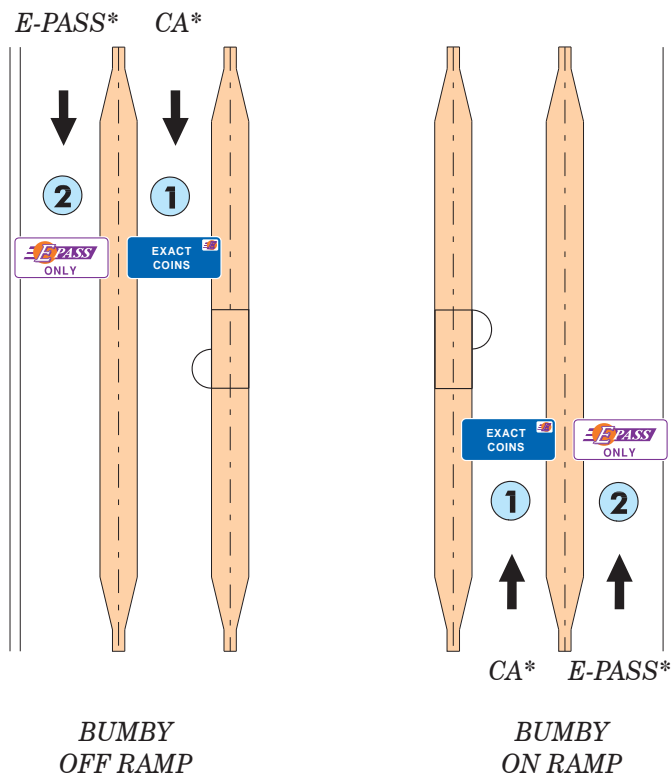
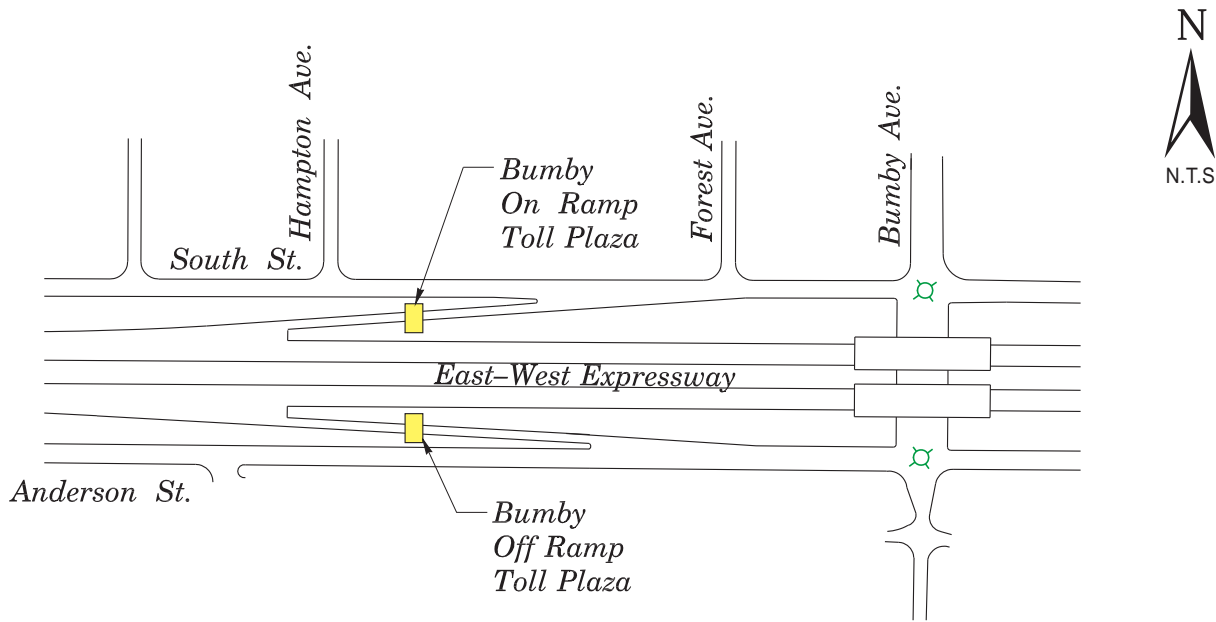

FARE STRUCTURE ALL VEHICLES	
Cash	Electronic
\$ 0.75	\$ 0.55

\* Changeable Message Sign

Note: All Changeable Message Signs (CMS) can display three messages: EXACT COINS, CHANGE RECEIPTS, E-PASS ONLY

Reports to Conway West Mainline Toll Plaza

T:\00CEANOCEA MANUAL STALL Facilities Reference Book\2016 Toll Manual - 3/10/16-CP

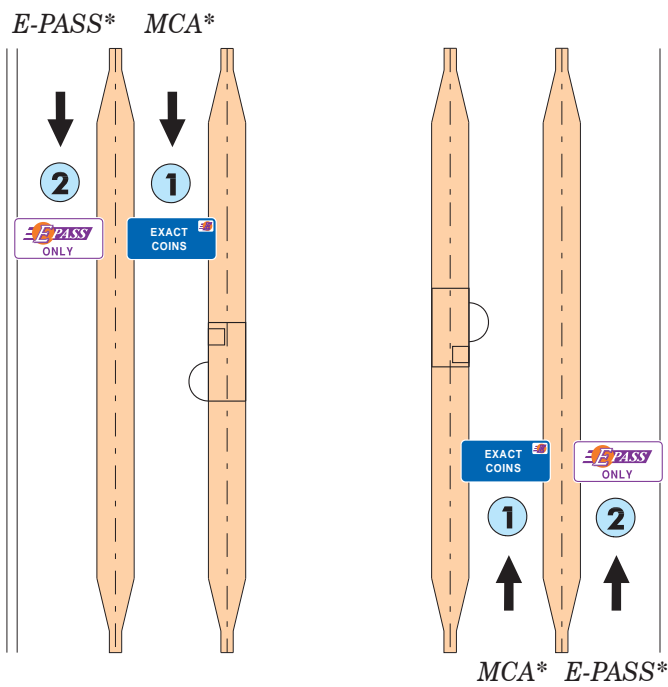
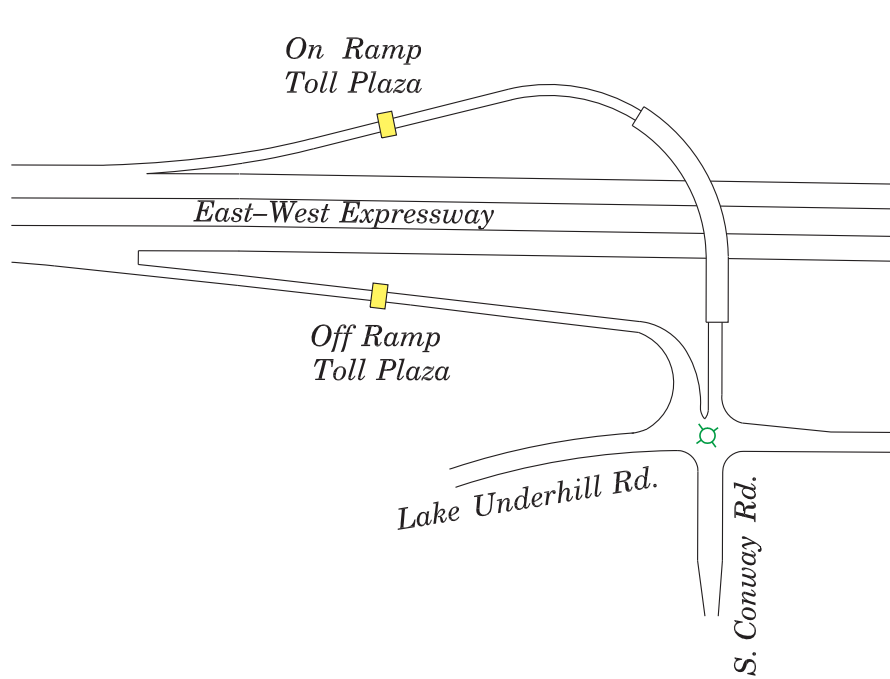

CONWAY  
OFF RAMP

CONWAY  
ON RAMP

Reports to Conway West Mainline Toll Plaza



FARE STRUCTURE ALL VEHICLES	
Cash	Electronic
\$ 1.00	\$ 0.82

\* Changeable Message Sign

Note: All Changeable Message Signs (CMS) can display three messages: EXACT COINS, CHANGE RECEIPTS, E-PASS ONLY

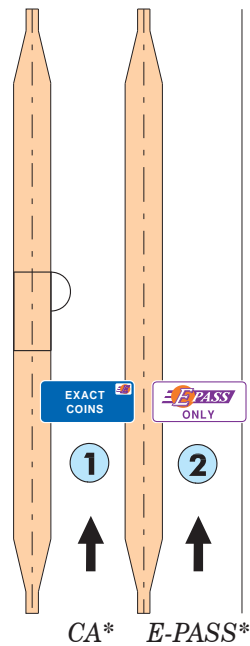
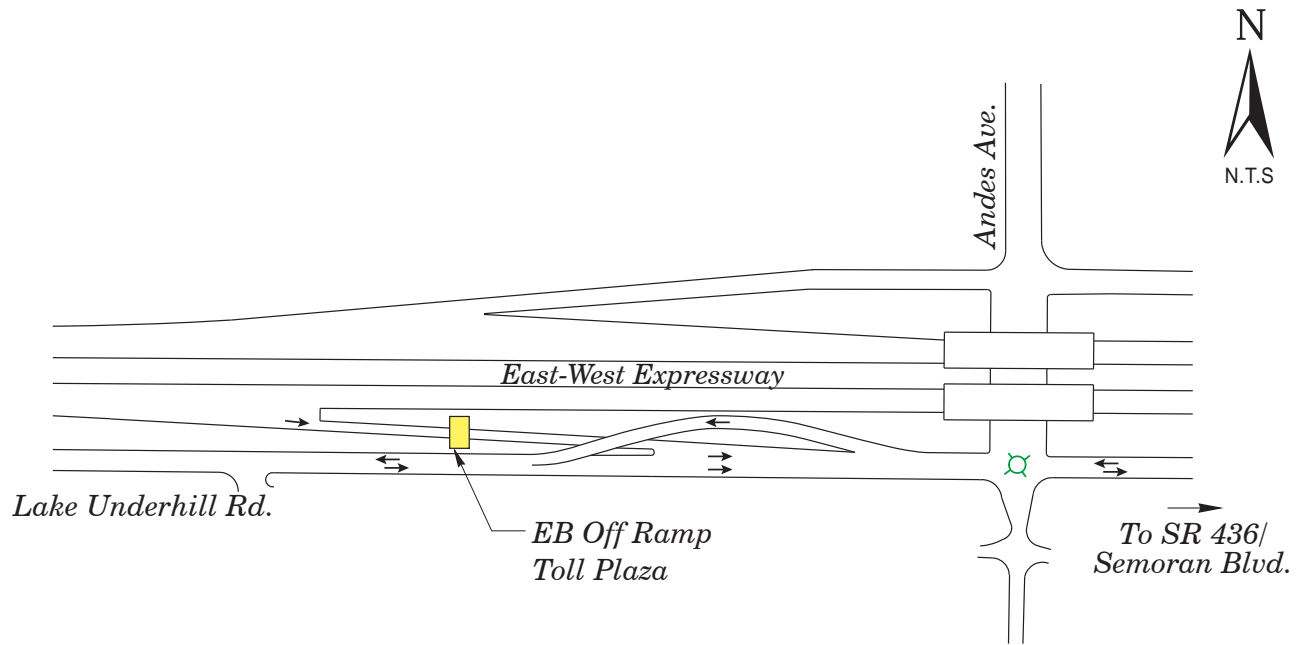

FARE STRUCTURE ALL VEHICLES	
Cash	Electronic
\$ 1.25	\$ 1.09

\* Changeable Message Sign

ANDES AVE. / LAKE UNDERHILL RD.  
SR 436 / SEMORAN BLVD.  
EASTBOUND OFF RAMP

Reports to Conway West Mainline Toll Plaza

Note: All Changeable Message Signs (CMS) can display three messages: EXACT COINS, CHANGE RECEIPTS, E-PASS ONLY

T:\00CEA\NOCEA MANUAL\ST01\Facilities Reference Book\2016 Toll Manual - 3/10/16-CP

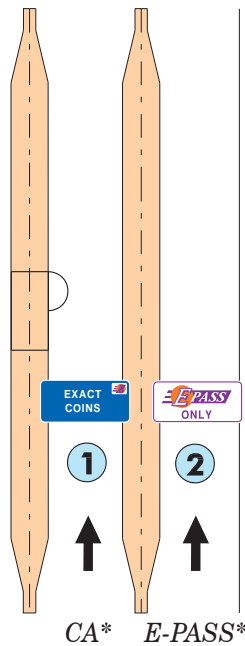
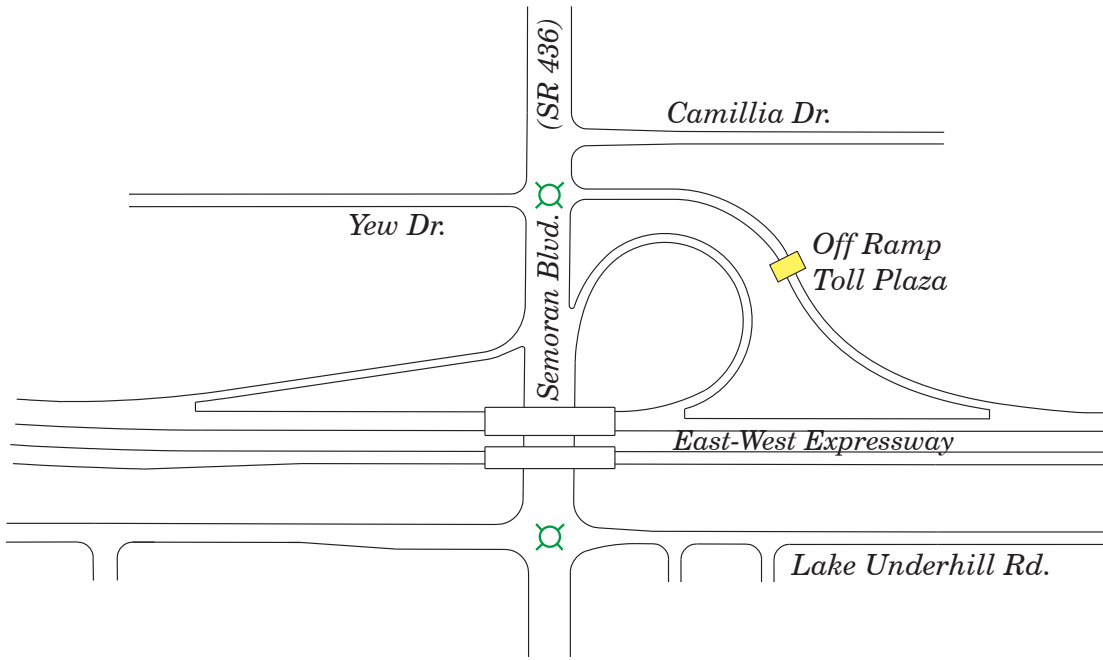

FARE STRUCTURE ALL VEHICLES	
Cash	Electronic
\$ 1.00	\$ 0.82

**SR 436 / SEMORAN  
WESTBOUND OFF RAMP**

Reports to Conway West Mainline Toll Plaza

\* All Changeable Message Signs (CMS) can display three messages: EXACT COINS, CHANGE RECEIPTS, E-PASS ONLY

T:\00CEANOCEA MANUAL\ST01\Facilities Reference Book\2016 Toll Manual - 3/10/16-CP

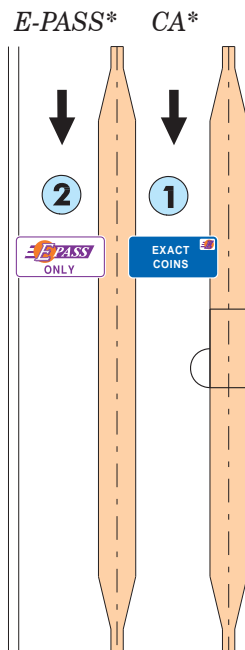
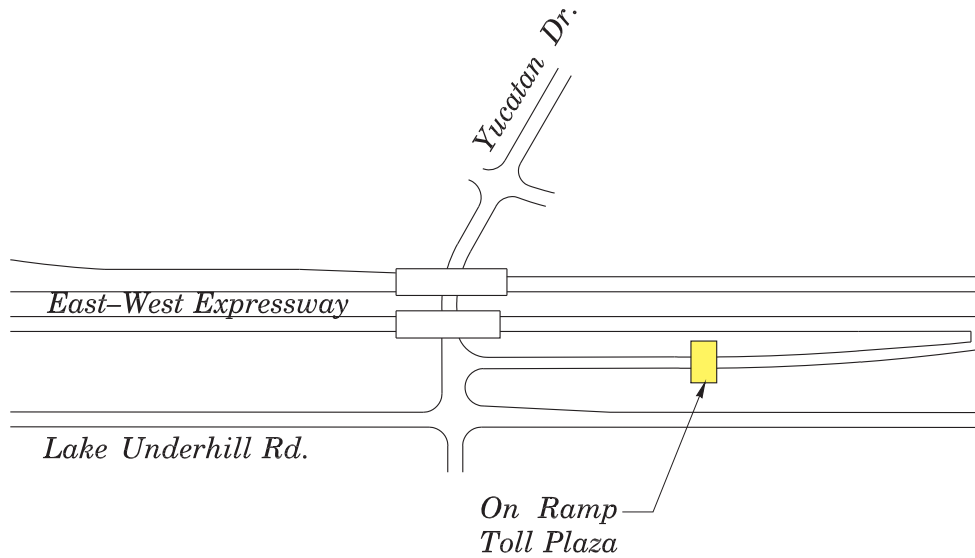

FARE STRUCTURE ALL VEHICLES	
Cash	Electronic
\$ 1.00	\$ 0.82

SR 436/YUCATAN  
ON RAMP

Reports to Conway West Mainline Toll Plaza

\* All Changeable Message Signs (CMS) can display three messages: EXACT COINS, CHANGE RECEIPTS, E-PASS ONLY

T:\00CEANOCEA MANUAL\ST01\Facilities Reference Book\2016 Tolls Manual - 3/10/16-CP



↑  
**To SR 417 (GreeneWay) & Downtown Orlando**  
 Next Interchange: Dean Rd.  
 Next Mainline Plaza: Conway East & West Mainline  
 Next Ramp Plaza: Dean EB-ON/WB-OFF



↓  
**To SR 50, UCF & Titusville**  
 Next Interchange: Rouse Rd.  
 Next Mainline Plaza: None  
 Next Ramp Plaza: Rouse EB-ON/WB-OFF

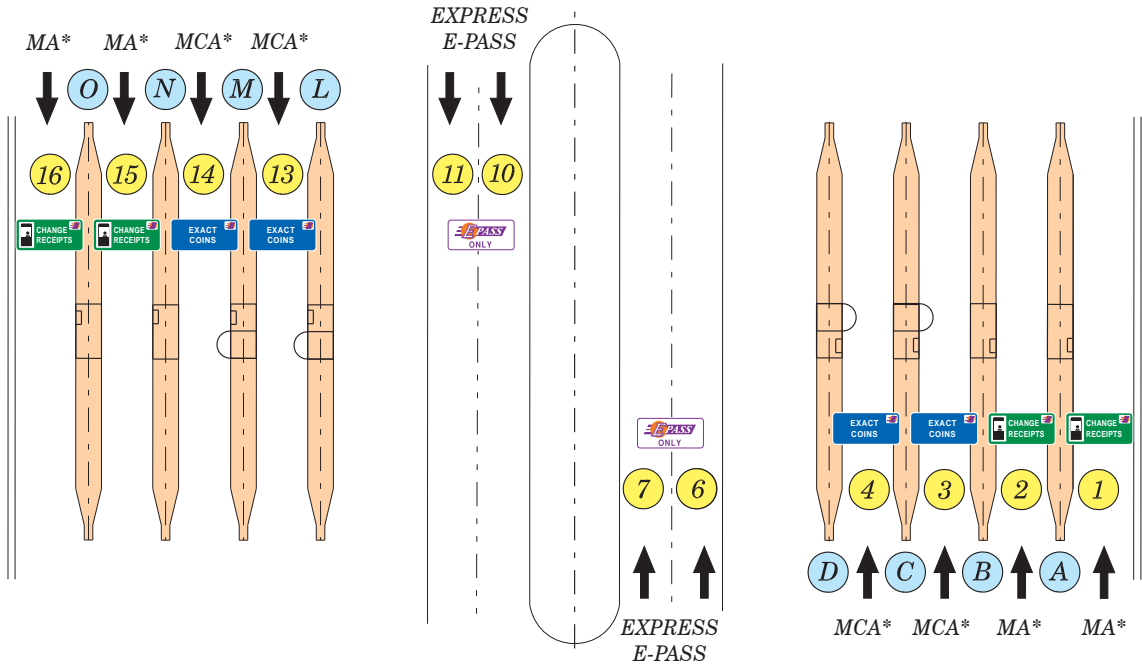

Note: All Changeable Message Signs (CMS) can display three messages: EXACT COINS, CHANGE RECEIPTS, E-PASS ONLY

<u>FARE STRUCTURE</u>		
	<u>Cash</u>	<u>Electronic</u>
2 Axles	\$ 1.00	\$ 0.82
3 Axles	\$ 1.75	\$ 1.64
4 Axles	\$ 2.00	\$ 1.91
5 Axles or more	\$ 2.50	\$ 2.46

- LANES OF EQUIPMENT
- 4 Express E-PASS (E-PASS only)
  - 4 Booths with Automatic Coin Machines with E-PASS (MCA)
  - 4 Manned Booths with E-PASS (MA)
  - \* Changeable Message Sign

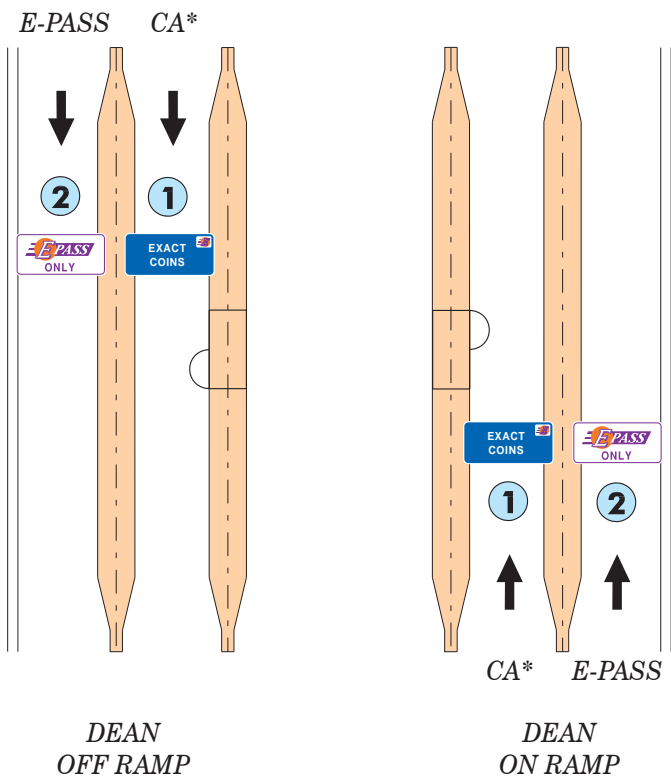
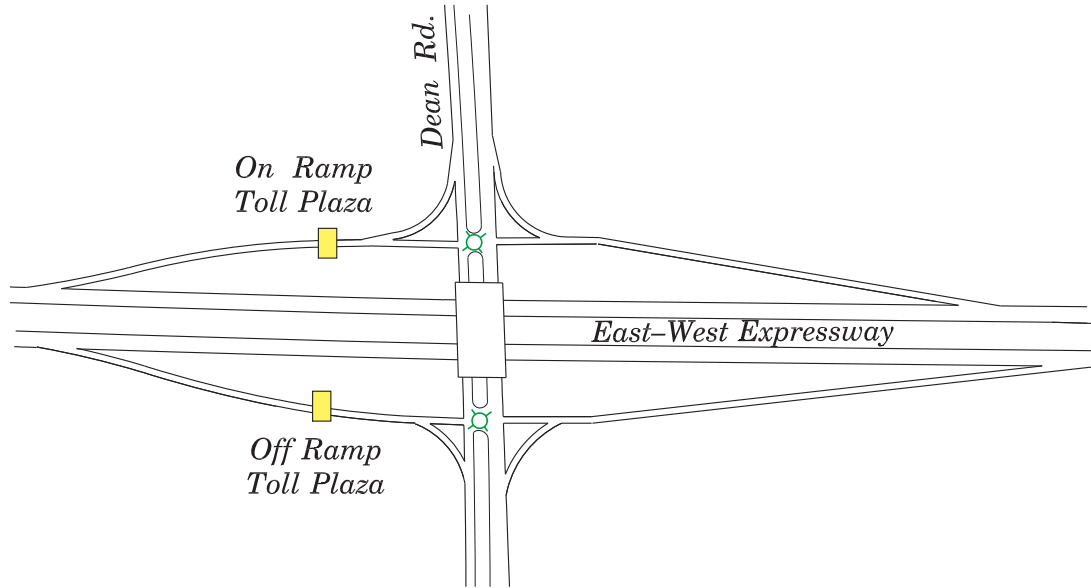

FARE STRUCTURE ALL VEHICLES	
Cash	Electronic
\$ 0.75	\$ 0.55

\* Changeable Message Sign

Note: All Changeable Message Signs (CMS) can display three messages: EXACT COINS, CHANGE RECEIPTS, E-PASS ONLY

Reports to Dean Mainline Toll Plaza

T:\00CEANOCEA MANUAL\ST01\Facilities Reference Book\2016 Toll Manual - 3/10/16-CP

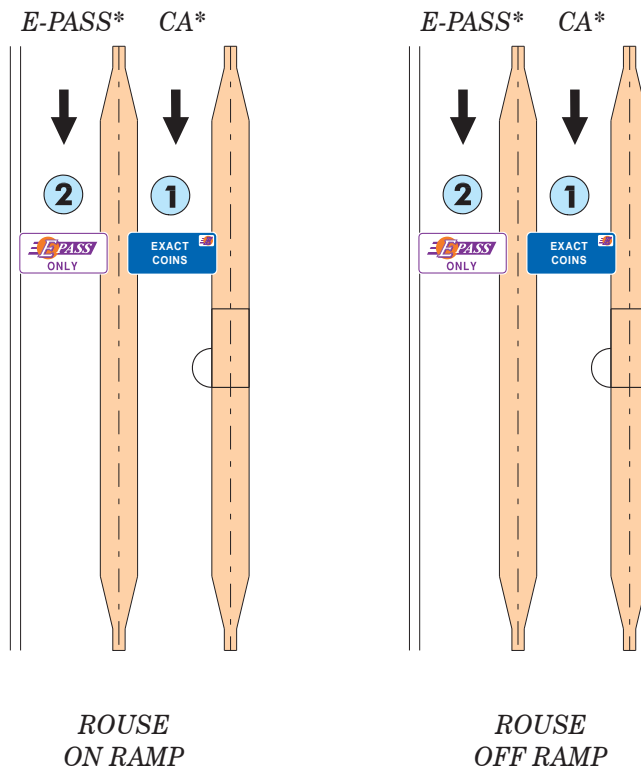
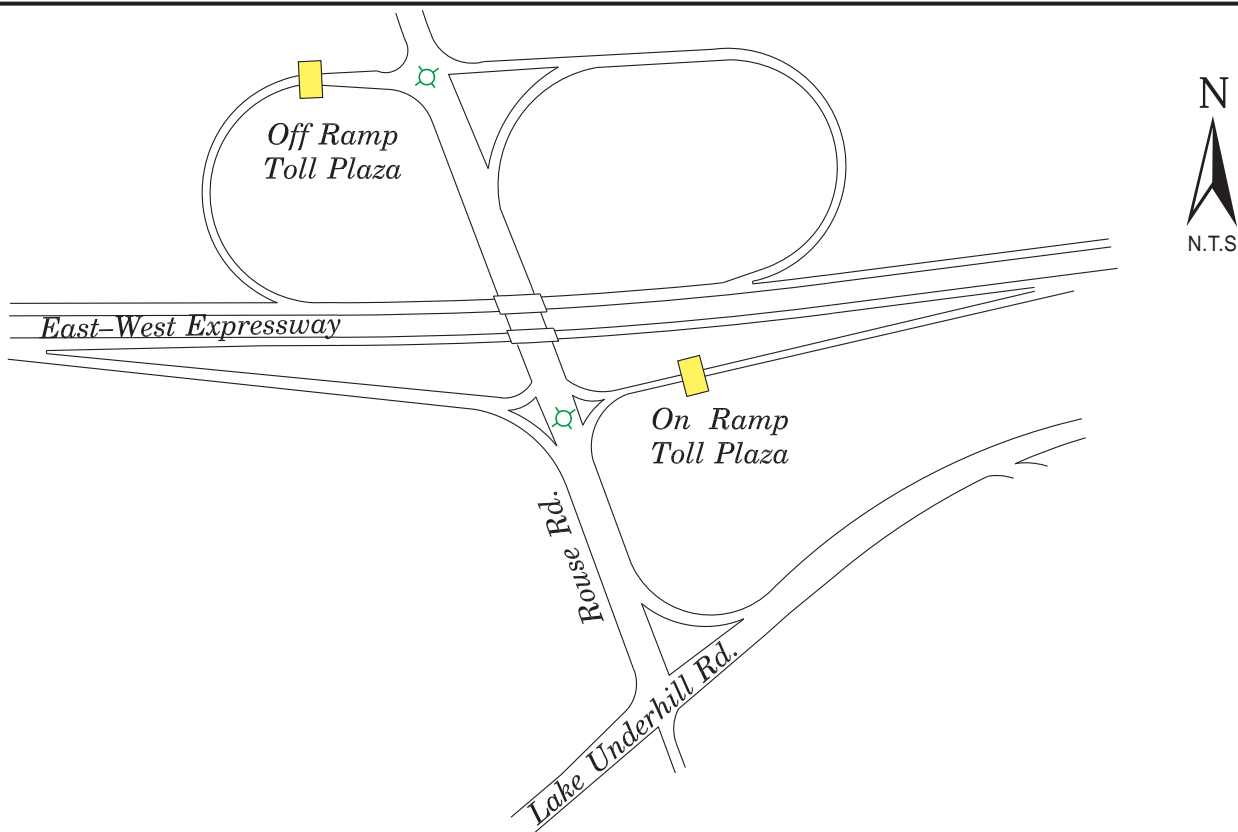

FARE STRUCTURE ALL VEHICLES	
Cash	Electronic
\$ 0.75	\$ 0.55

\* Changeable Message Sign

Note: All Changeable Message Signs (CMS) can display three messages: EXACT COINS, CHANGE RECEIPTS, E-PASS ONLY

Reports to Dean Mainline Toll Plaza

T:\00CEANOCEA MANUAL\STall Facilities Reference Book\2016 Toll Manual - 3/10/16-CP

# John Land Apopka Expressway



## Mainline Toll Plaza and Associated Tolloed Ramps

### LEGEND

*For Lane Designations for all Plazas*

*CA - Exact Coin with E-PASS*

*MA - Change Receipts (Manned) with E-PASS*

*MCA - Booth with Manual Lane Terminal,  
Automatic Coin Machine and E-PASS*



To SR 429, Apopka

Next Interchange: SR 429  
 Next Mainline Plaza: None  
 Next Ramp Plaza: None

To US 441, I-4, Maitland, US 17/92

Next Interchange: Hiwassee Rd.  
 Next Mainline Plaza: None  
 Next Ramp Plaza: Hiwassee Rd.  
 EB-ON/WB-OFF

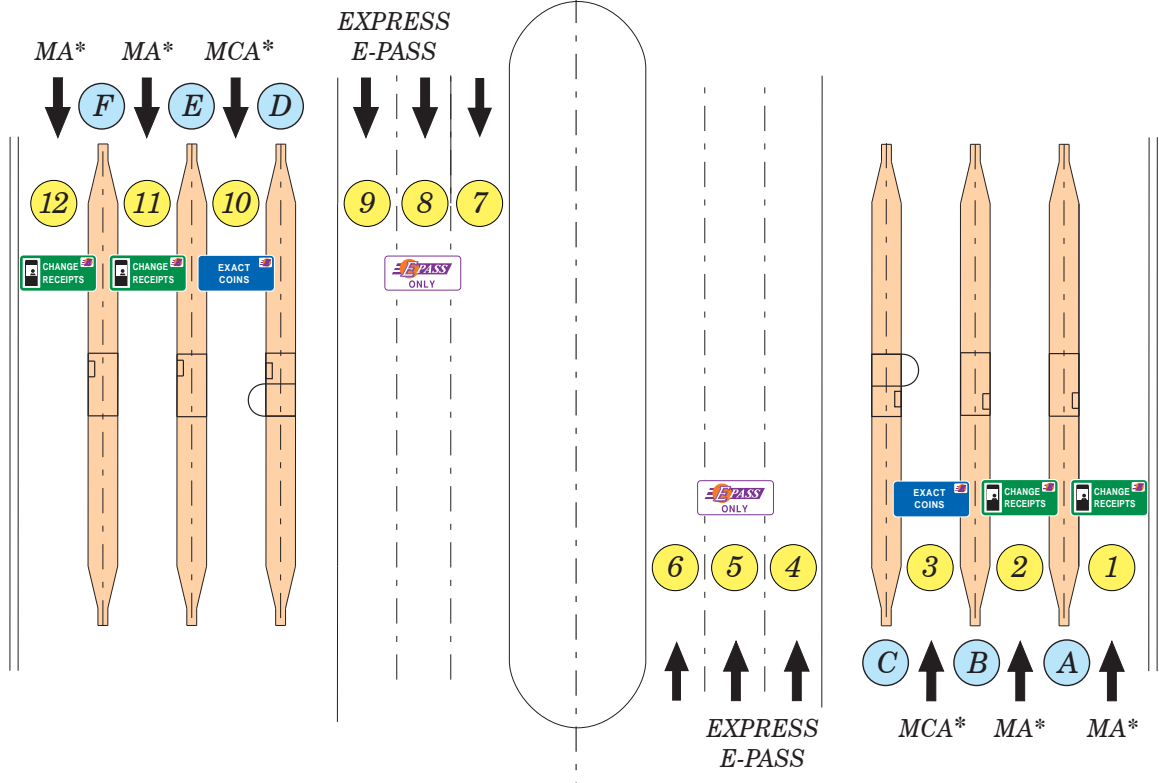

**FARE STRUCTURE**

	Cash	Electronic
2 Axles	\$ 1.25	\$ 1.09
3 Axles	\$ 1.75	\$ 1.64
4 Axles	\$ 2.25	\$ 2.18
5 Axles or more	\$ 2.75	\$ 2.73

- LANES OF EQUIPMENT**
- 4 Manned Booths with E-PASS (MA)
  - 2 Booths with ACM's and E-PASS
  - 6 Express E-PASS (E-PASS only)
  - \* Changeable Message Sign

Note: All Changeable Message Signs (CMS) can display three messages: EXACT COINS, CHANGE RECEIPTS, E-PASS ONLY

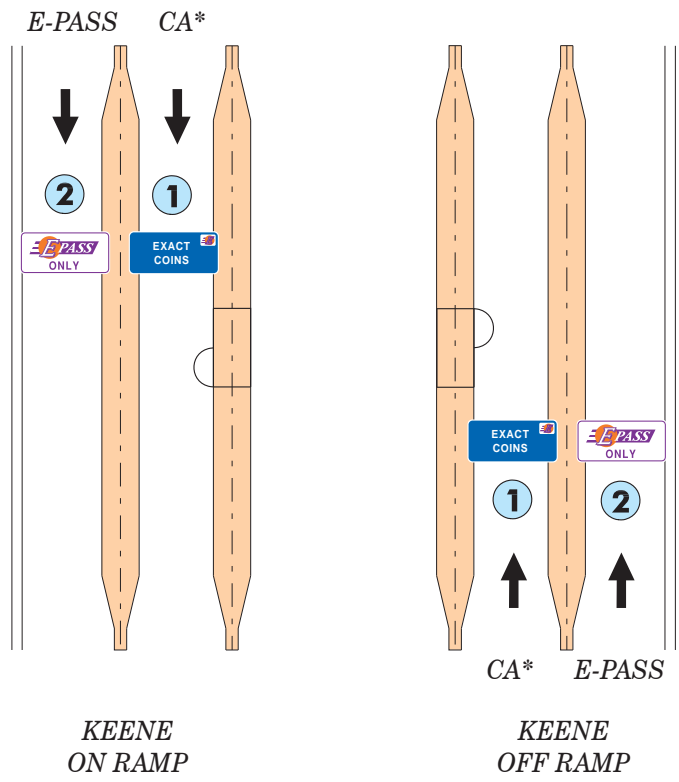
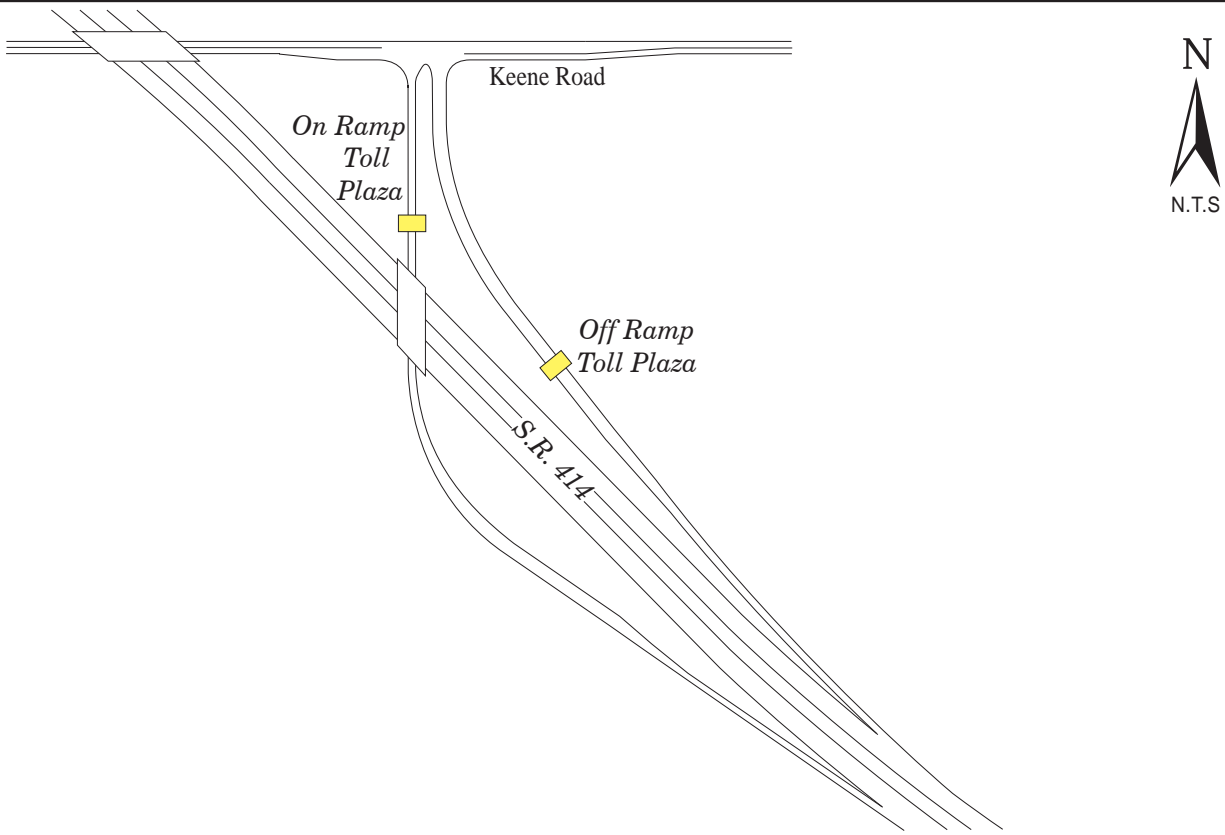

FARE STRUCTURE ALL VEHICLES	
Cash	Electronic
\$ 0.75	\$ 0.55

\* Changeable Message Sign

Note: All Changeable Message Signs (CMS) can display three messages: EXACT COINS, CHANGE RECEIPTS, E-PASS ONLY

Reports to Coral Hills Mainline Toll Plaza

T:\00CEANOCEA MANUAL\Still Facilities Reference Book\2016 Toll Manual - 3/10/16-CP

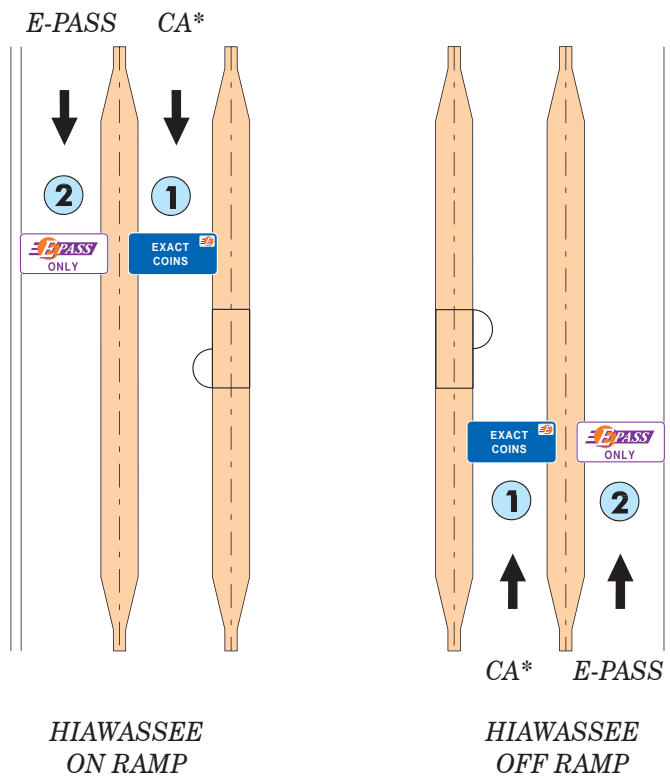
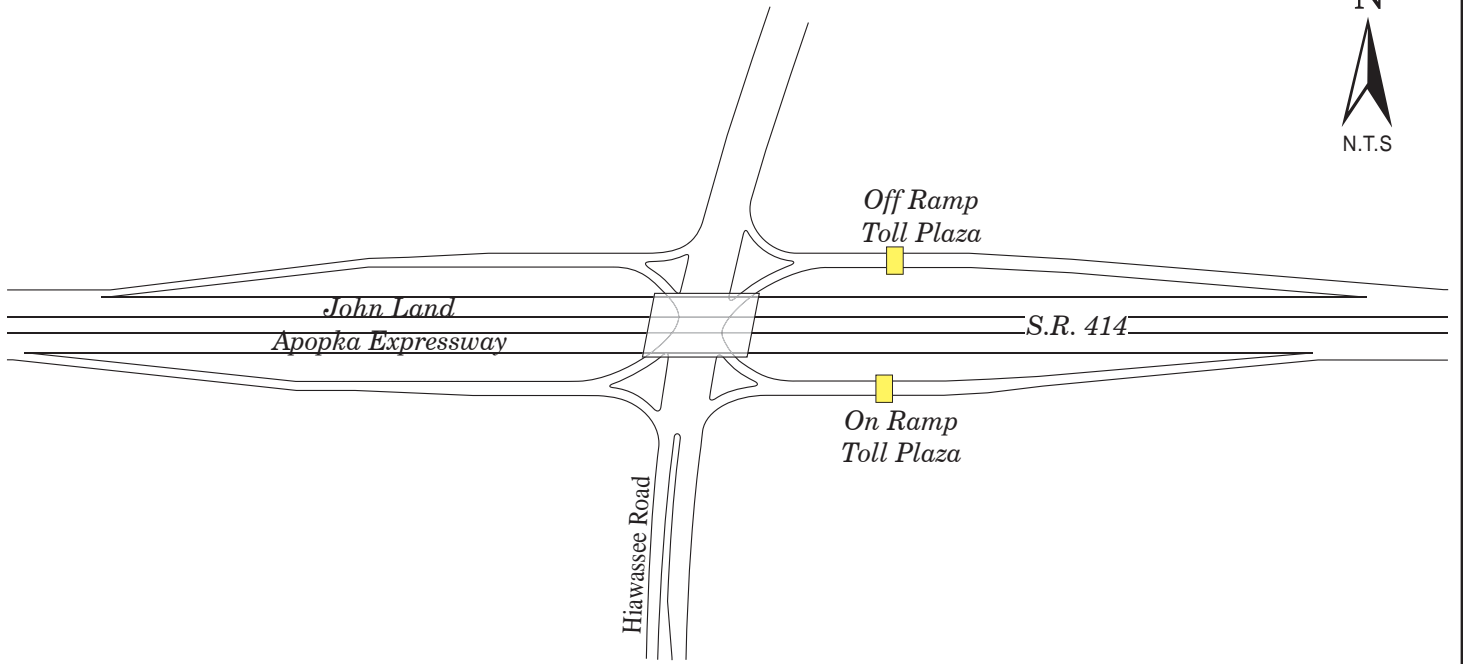

FARE STRUCTURE ALL VEHICLES	
Cash	Electronic
\$ 0.50	\$ 0.28

\* Changeable Message Sign

Note: All Changeable Message Signs (CMS) can display three messages: EXACT COINS, CHANGE RECEIPTS, E-PASS ONLY

Reports to Coral Hills Mainline Toll Plaza

T:\DOCEANODOCEA MANUAL\STall Facilities Reference Book\2016 Toll Manual - 3/10/16-CP

# Central Florida GreeneWay



## Mainline Toll Plazas and Associated Tolloed Ramps

### LEGEND

*For Lane Designations for all Plazas*

*CA - Exact Coin with E-PASS*

*MA - Change Receipts (Manned) with E-PASS*

*MCA - Booth with Manual Lane Terminal,  
Automatic Coin Machine and E-PASS*





↑  
**To Orlando Int'l Airport,  
 SR 528 (Beachline), Sanford**  
*Next Interchange: John Young Pkwy.  
 Next Mainline Plaza: Boggy Creek Mainline  
 Next Ramp Plaza: John Young Pkwy.  
 EB-ON/WB-OFF*

↓  
**To International Drive &  
 I-4 (Walt Disney World)**  
*Next Interchange: International Drive  
 Next Mainline Plaza: Celebration Mainline  
 (Turnpike)  
 Next Ramp Plaza: Osceola Parkway (Turnpike)  
 EB-OFF/WB-ON*

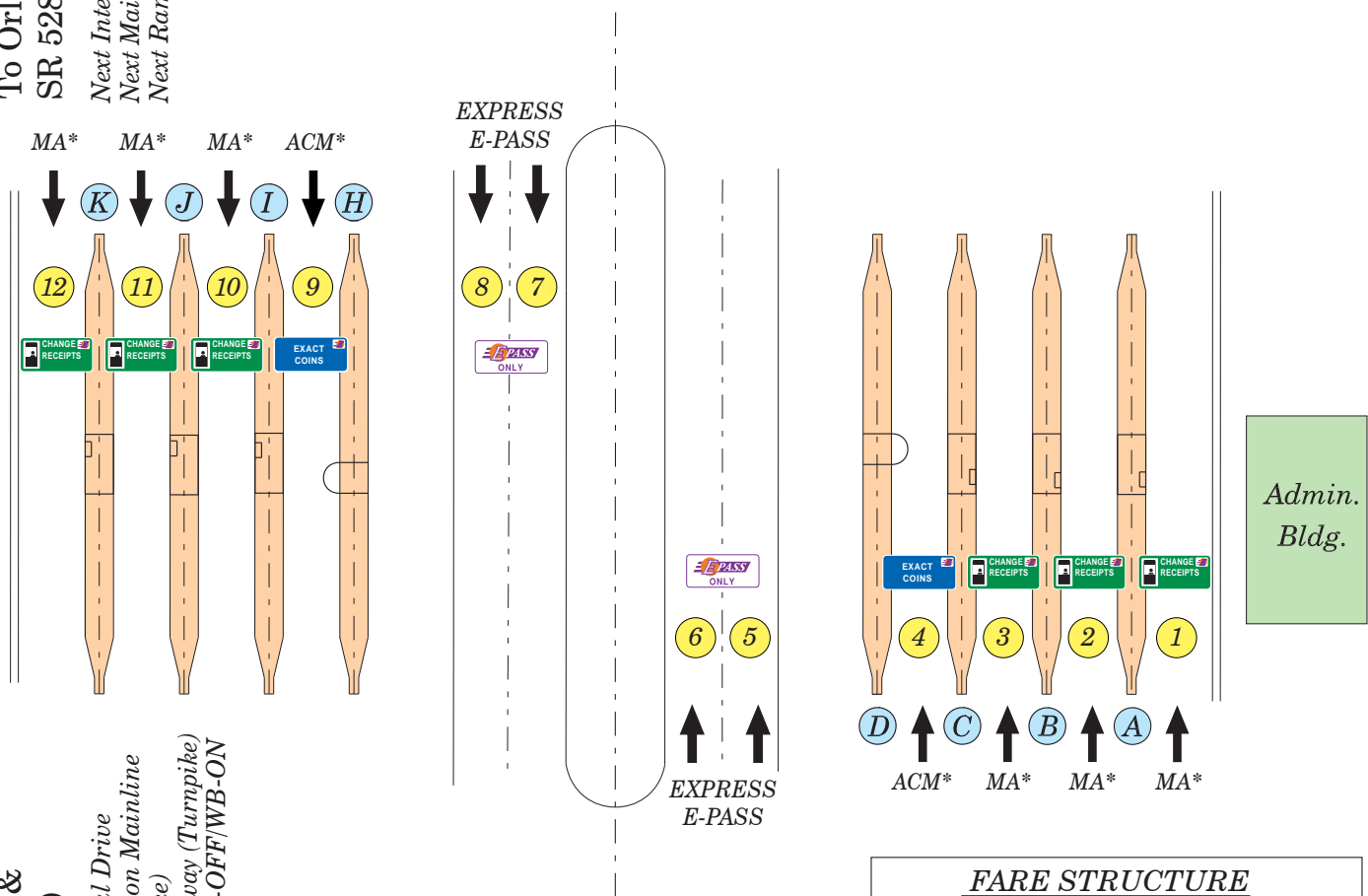

**FARE STRUCTURE**

	Cash	Electronic
2 Axles	\$ 1.50	\$ 1.37
3 Axles	\$ 2.00	\$ 1.91
4 Axles	\$ 2.50	\$ 2.46
5 Axles or more	\$ 3.00	\$ 3.00

- LANES OF EQUIPMENT**
- 6 Manned Booths with E-PASS (MA)
  - 2 ACM's with (E-PASS)
  - 4 Express E-PASS only
  - \* Changeable Message Sign

*Note: All Changeable Message Signs (CMS) can display three messages: EXACT COINS, CHANGE RECEIPTS, E-PASS ONLY*

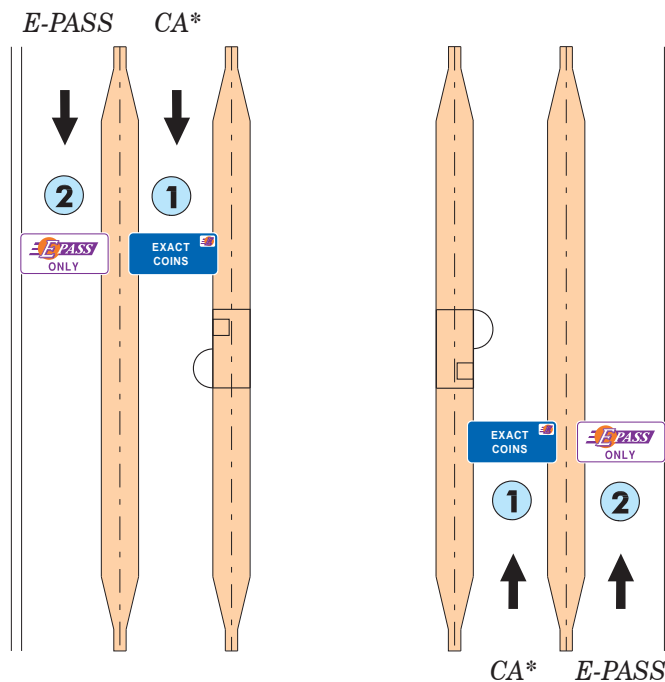
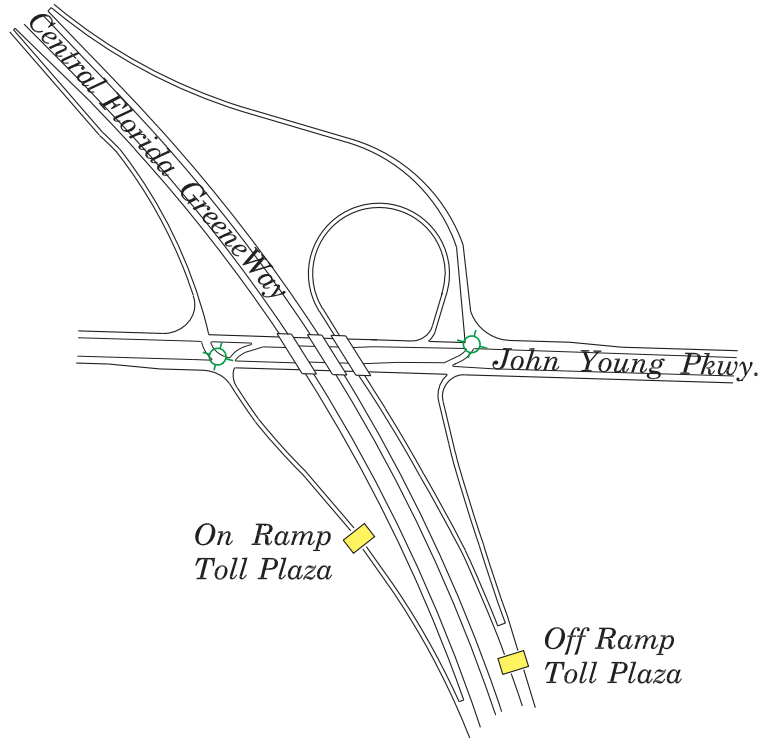

JOHN YOUNG PARKWAY  
ON RAMP

JOHN YOUNG PARKWAY  
OFF RAMP

Reports to John Young Mainline Toll Plaza

FARE STRUCTURE ALL VEHICLES	
Cash	Electronic
\$ 1.00	\$ 0.82

\* Changeable Message Sign

Note: All Changeable Message Signs (CMS) can display three messages: EXACT COINS, CHANGE RECEIPTS, E-PASS ONLY

T:\00CEANOCEA MANUAL\Stall Facilities Reference Book\2016 Toll Manual - 3/10/16-CP

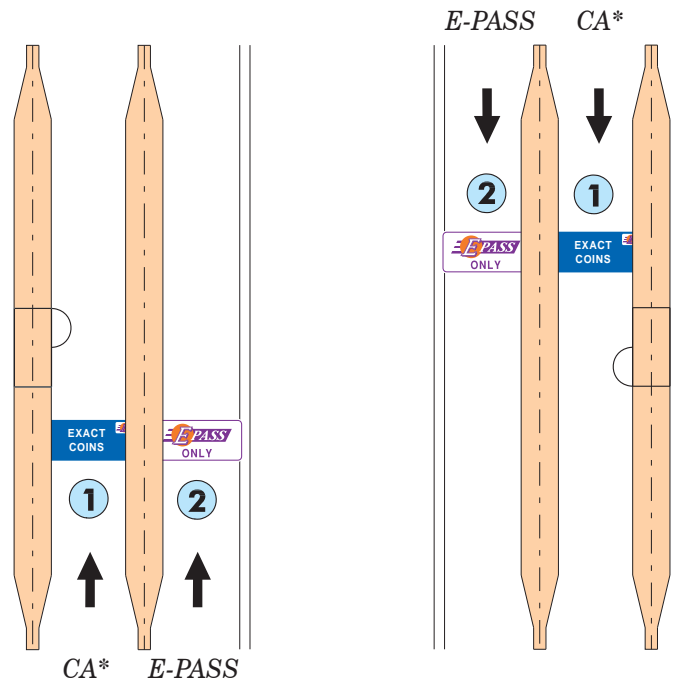
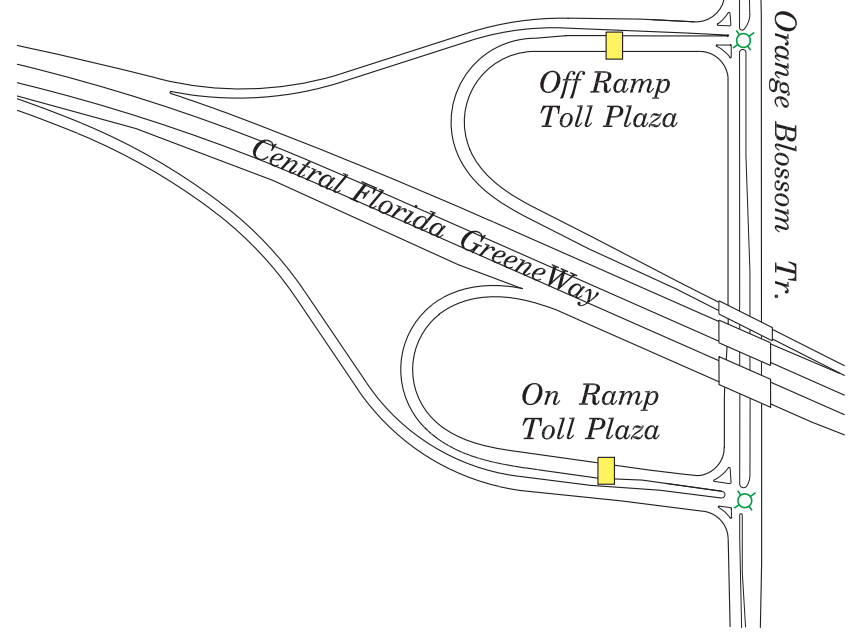

FARE STRUCTURE ALL VEHICLES	
Cash	Electronic
\$ 0.75	\$ 0.55

\* Changeable Message Sign

OBT  
ON RAMP

OBT  
OFF RAMP

Reports to John Young Mainline Toll Plaza

Note: All Changeable Message Signs (CMS) can display three messages: EXACT COINS, CHANGE RECEIPTS, E-PASS ONLY

T:\DOCEANODOCEA MANUAL\STall Facilities Reference Book\2016 Toll Manual - 3/10/16-CP

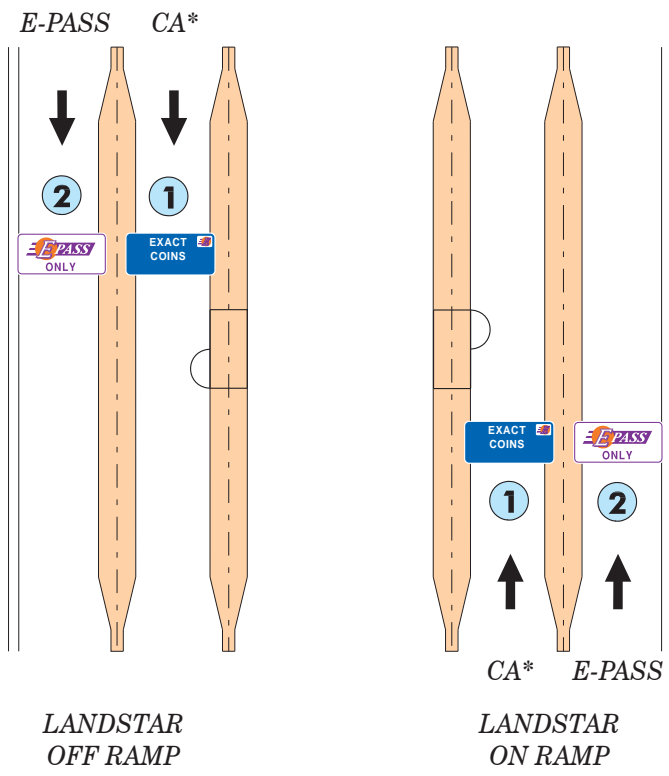
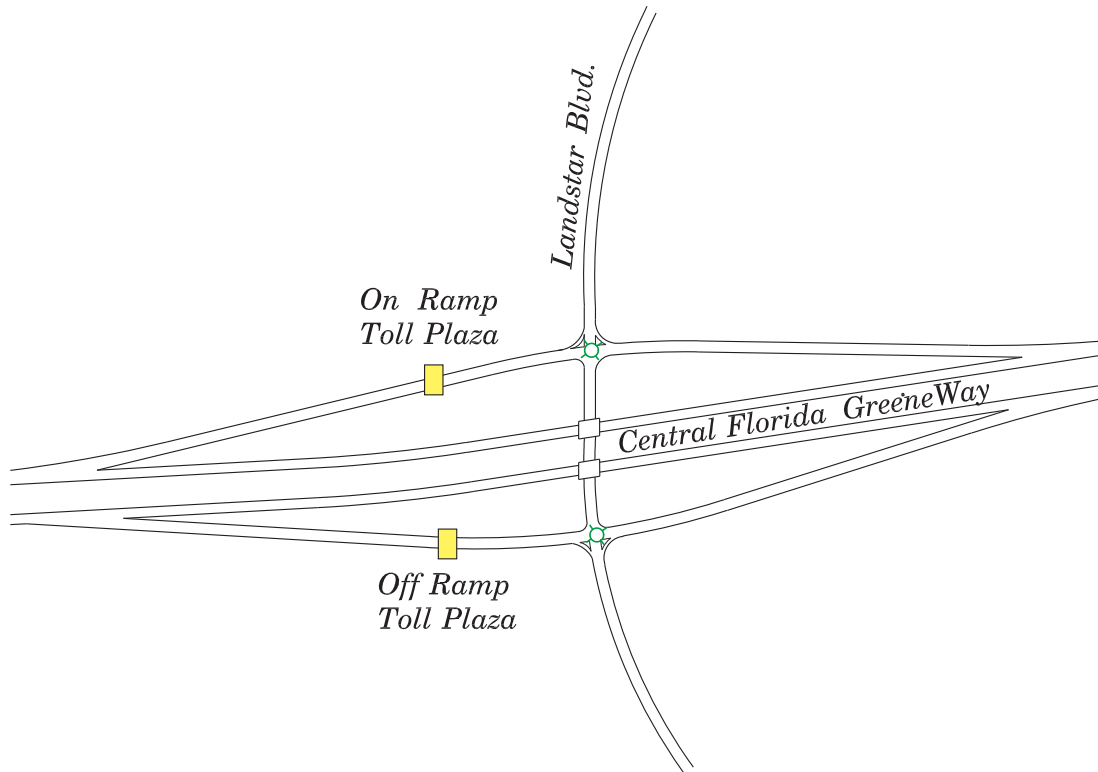

FARE STRUCTURE ALL VEHICLES	
Cash	Electronic
\$ 0.50	\$ 0.50

Reports to John Young Mainline Toll Plaza

Note: All Changeable Message Signs (CMS) can display three messages: EXACT COINS, CHANGE RECEIPTS, E-PASS ONLY

T:\DOCEANODOCEA MANUAL\Still Facilities Reference Book\2016 Toll Manual - 3/10/16-CP



↑  
**To Orlando Int'l. Airport,  
 SR 528 (Beachline), Sanford**  
 Next Interchange: Boggy Creek Rd.  
 Next Mainline Plaza: Curry Ford Mainline  
 Next Ramp Plaza: Boggy Creek  
 EB-ON/WB-OFF

↓  
**To International Drive & I-4  
 (Walt Disney World Area)**  
 Next Interchange: Landstar Blvd.  
 Next Mainline Plaza: John Young Mainline  
 Next Ramp Plaza: Landstar  
 WB-ON/EB-OFF

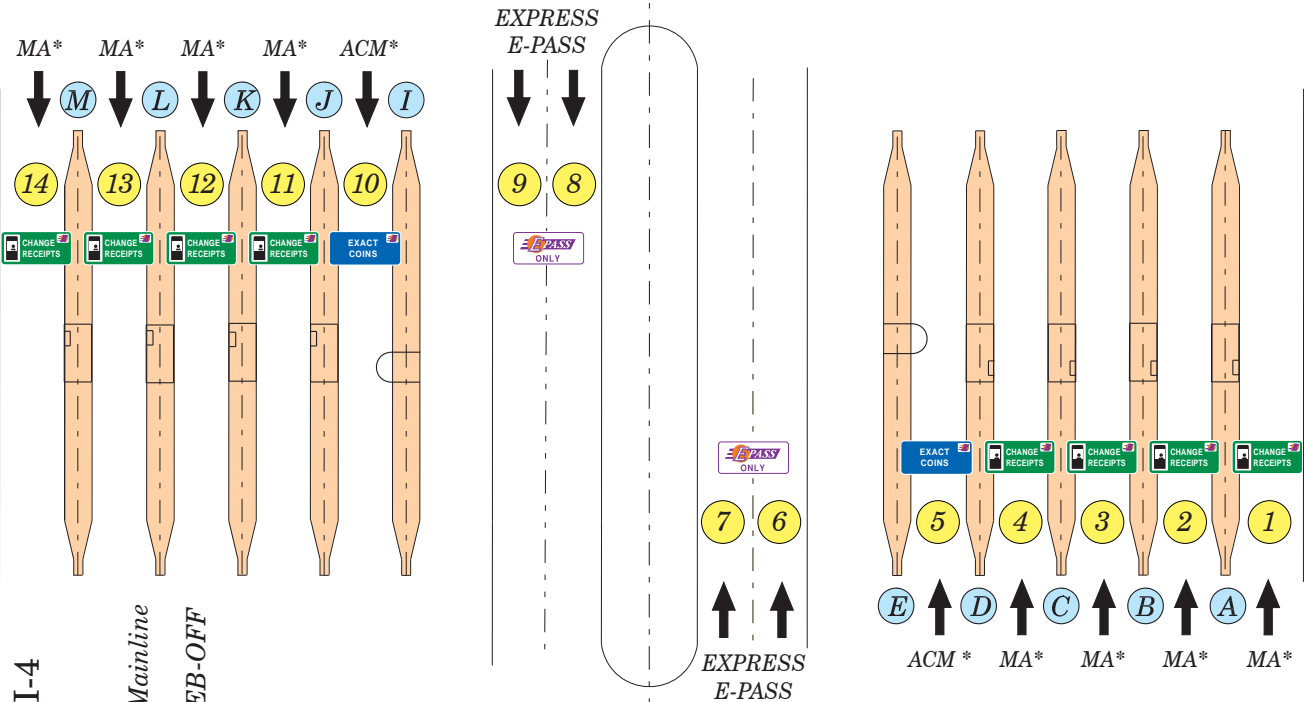

**FARE STRUCTURE**

	Cash	Electronic
2 Axles	\$ 1.50	\$ 1.37
3 Axles	\$ 2.00	\$ 1.91
4 Axles	\$ 2.50	\$ 2.46
5 Axles or more	\$ 3.00	\$ 3.00

- LANES OF EQUIPMENT**
- 8 Manned Booths with E-PASS (MA)
  - 2 ACM with E-PASS
  - 4 Express E-PASS
  - \* Changeable Message Sign

*Note: All Changeable Message Signs (CMS) can display three messages: EXACT COINS, CHANGE RECEIPTS, E-PASS ONLY*

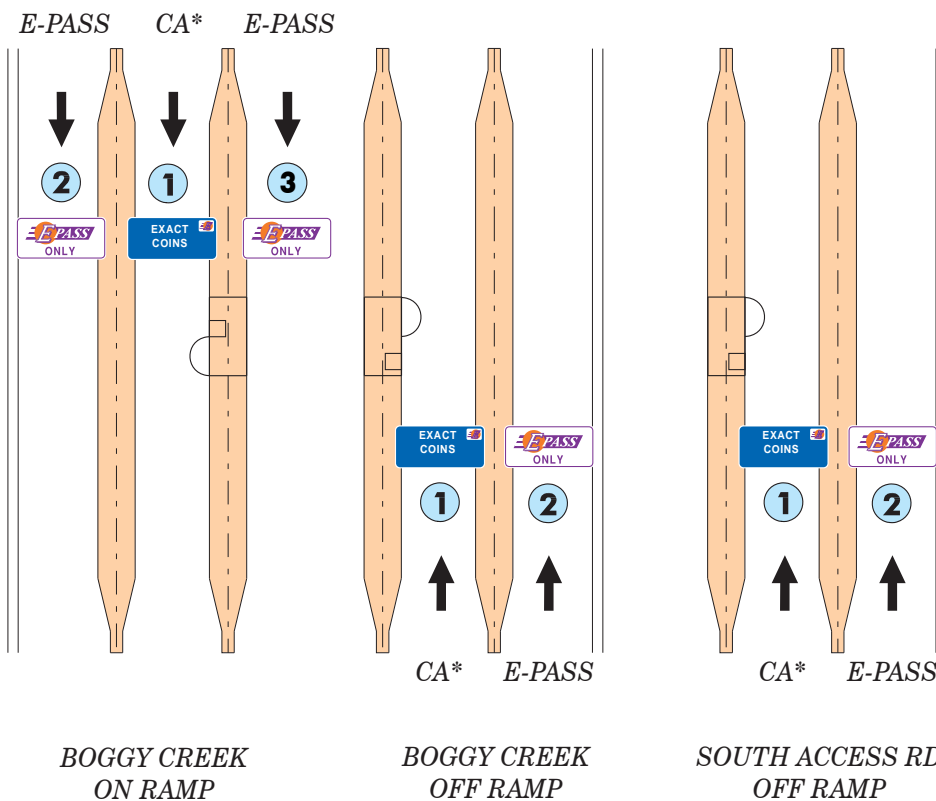
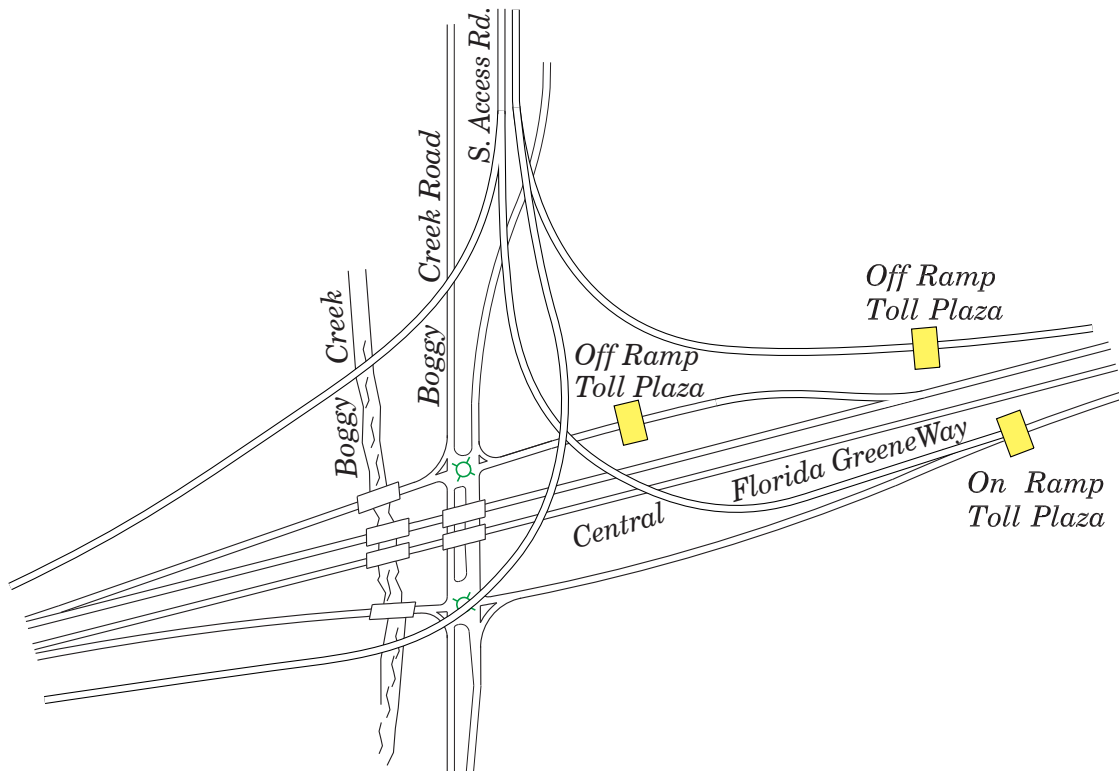

FARE STRUCTURE ALL VEHICLES	
Cash	Electronic
\$ 1.25	\$ 1.09

\* Changeable Message Sign (ACM/CA)

Note: All Changeable Message Signs (CMS) can display three messages: EXACT COINS, CHANGE RECEIPTS, E-PASS ONLY

Reports to Boggy Creek Mainline Toll Plaza

T:\DOCEANODOCEA MANUAL\Still Facilities Reference Book\2016 Toll Manual - 3/10/16-CP

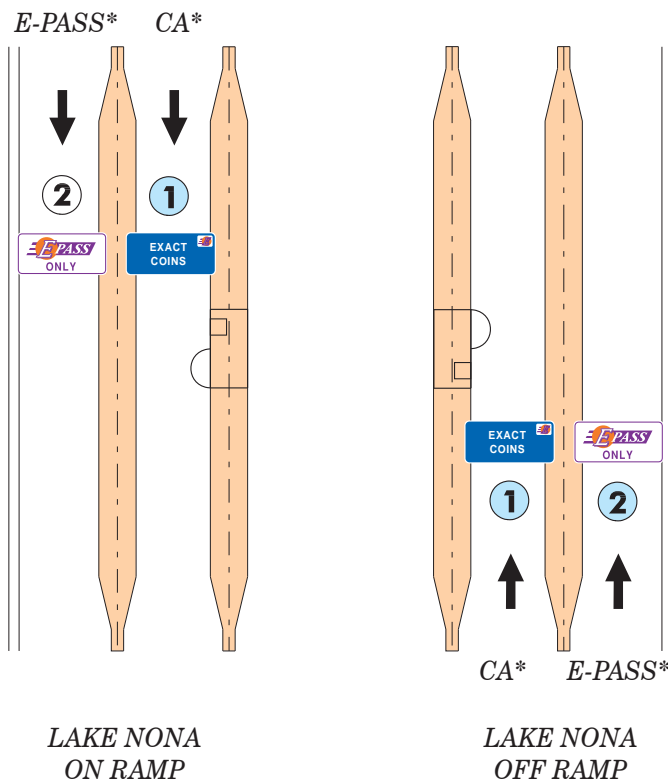
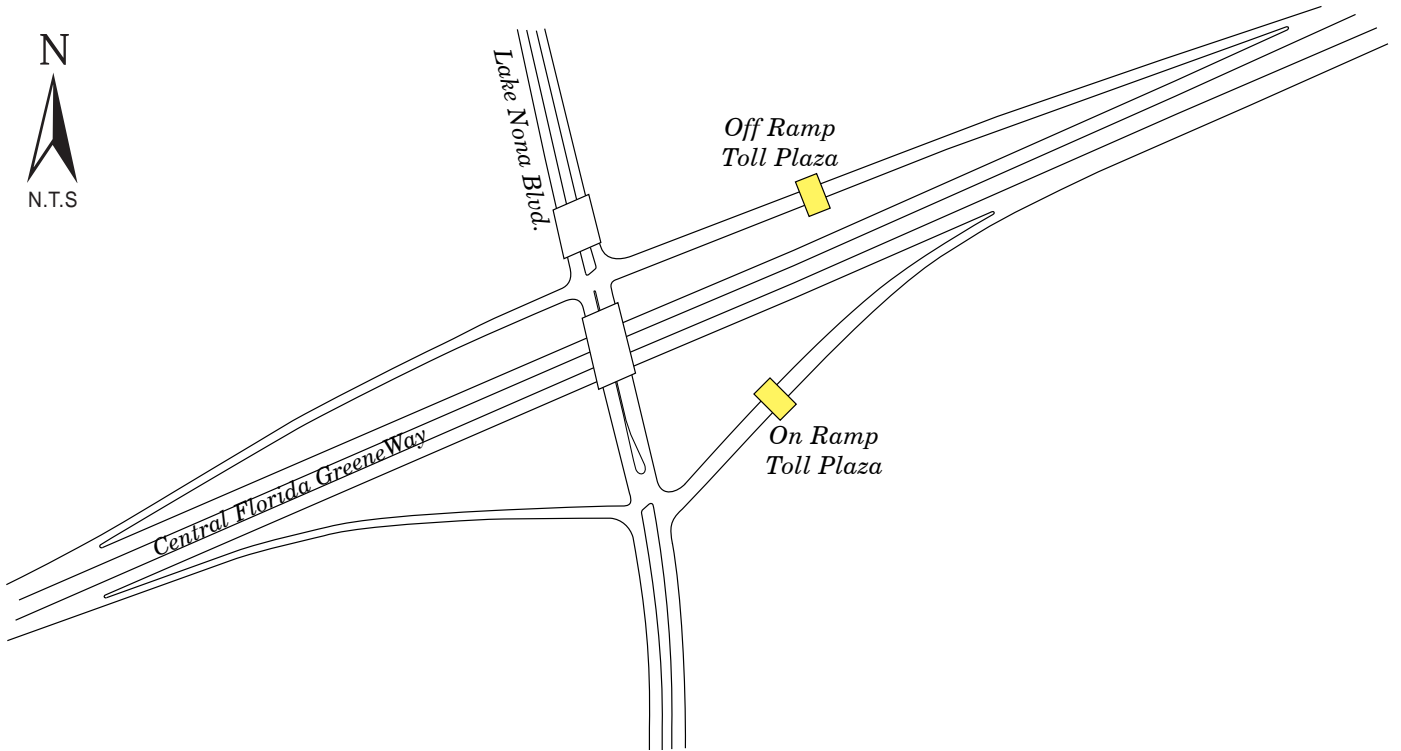

FARE STRUCTURE ALL VEHICLES	
Cash	Electronic
\$ 1.00	\$ 0.82

\* Changeable Message Sign

Reports to Boggy Creek Mainline Toll Plaza

Note: All Changeable Message Signs (CMS) can display three messages: EXACT COINS, CHANGE RECEIPTS, E-PASS ONLY

T:\DOCEANODOCEA MANUAL\STall Facilities Reference Book\2016 Toll Manual - 3/10/16-CP

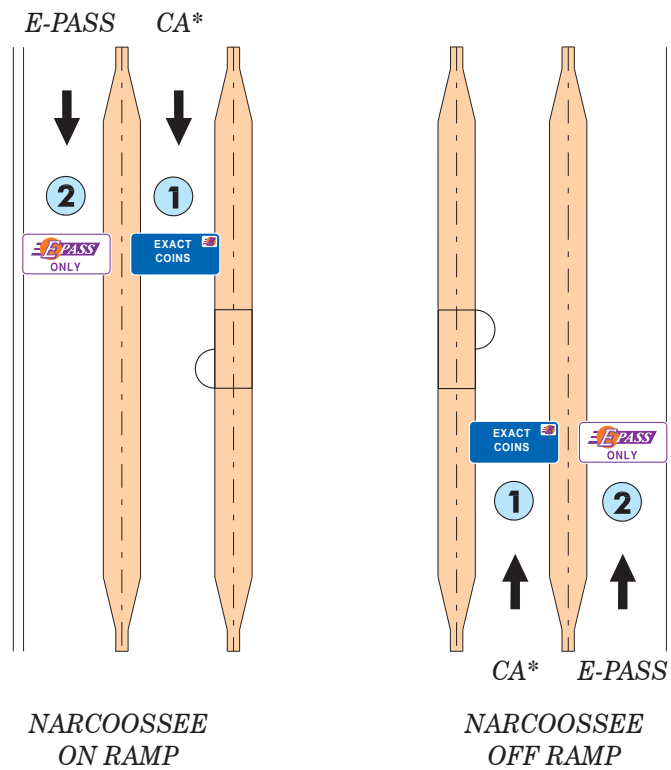
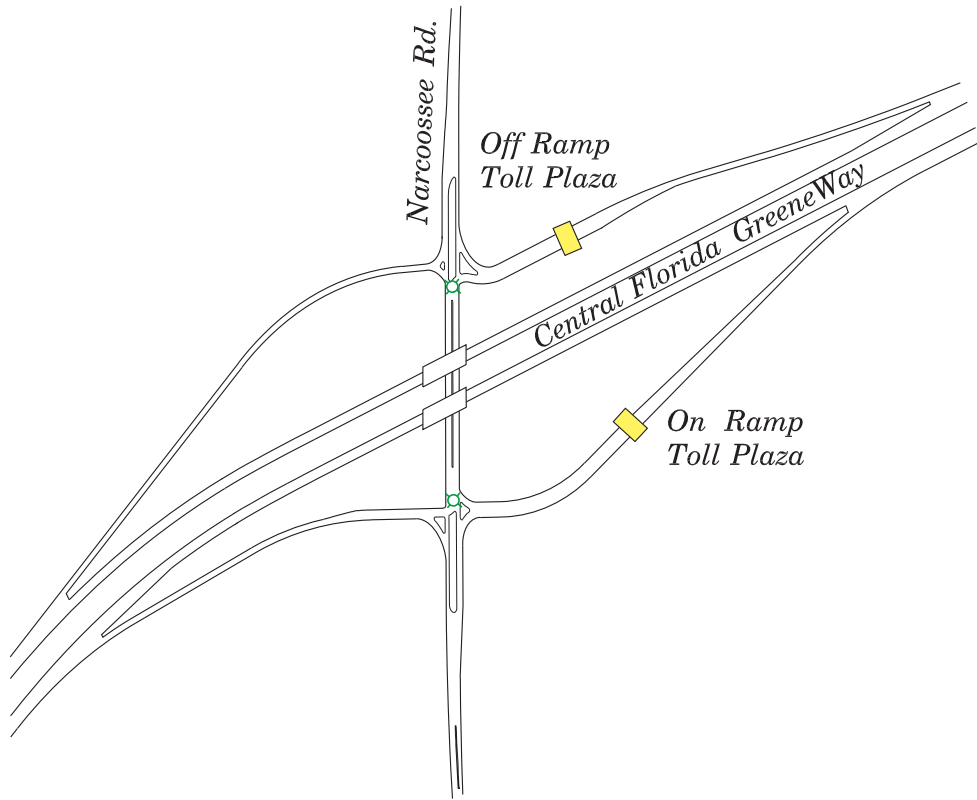

FARE STRUCTURE ALL VEHICLES	
Cash	Electronic
\$ 1.00	\$ 0.82

\* Changeable Message Sign

Reports to Boggy Creek Mainline Toll Plaza

Note: All Changeable Message Signs (CMS) can display three messages: EXACT COINS, CHANGE RECEIPTS, E-PASS ONLY

T:\00CEANOCEA MANUAL\ST01\Facilities Reference Book\2016 Toll Manual - 3/10/16-CP



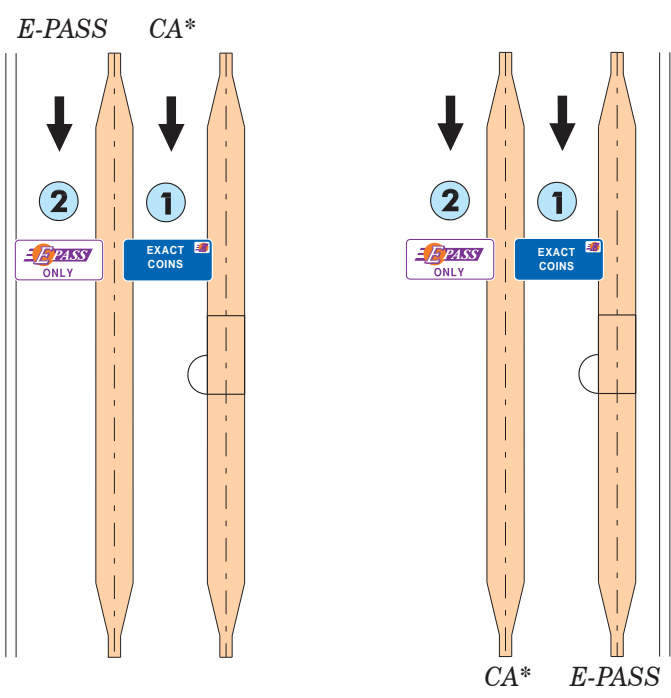
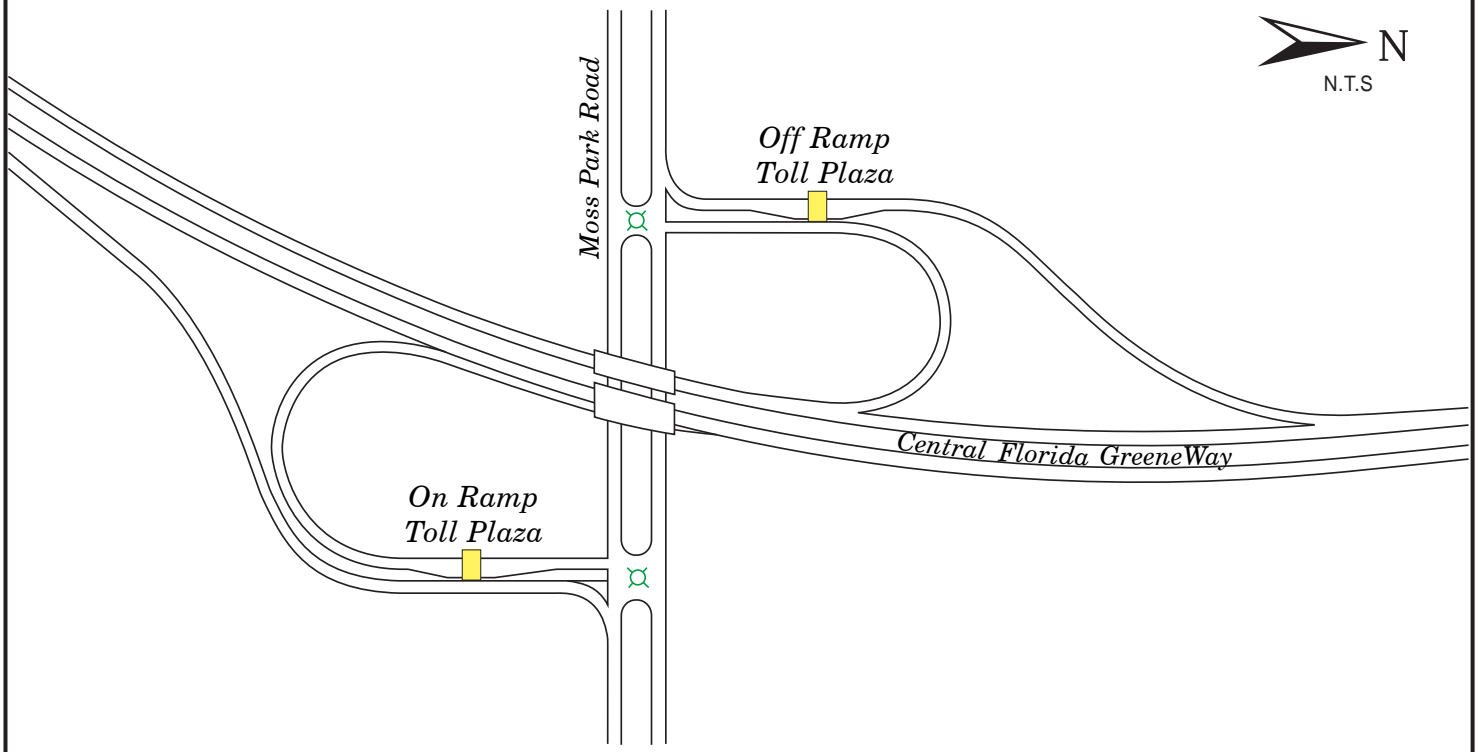

MOSS PARK  
OFF RAMP

MOSS PARK  
ON RAMP

Reports to Boggy Creek Mainline Toll Plaza

FARE STRUCTURE ALL VEHICLES	
Cash	Electronic
\$ 0.75	\$ 0.55

\* Changeable Message Sign

Note: All Changeable Message Signs (CMS) can display three messages: EXACT COINS, CHANGE RECEIPTS, E-PASS ONLY

T:\DOCEANODOCEA MANUAL\STall Facilities Reference Book\2016 Toll Manual - 3/10/16-CP

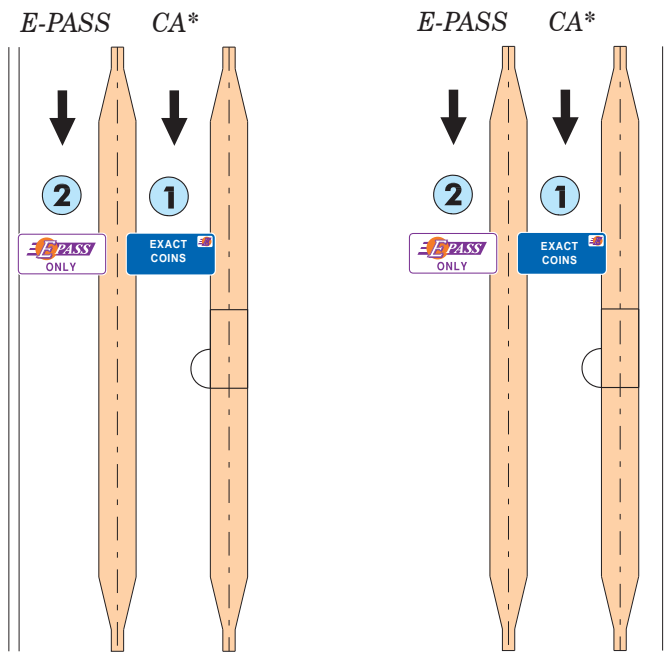
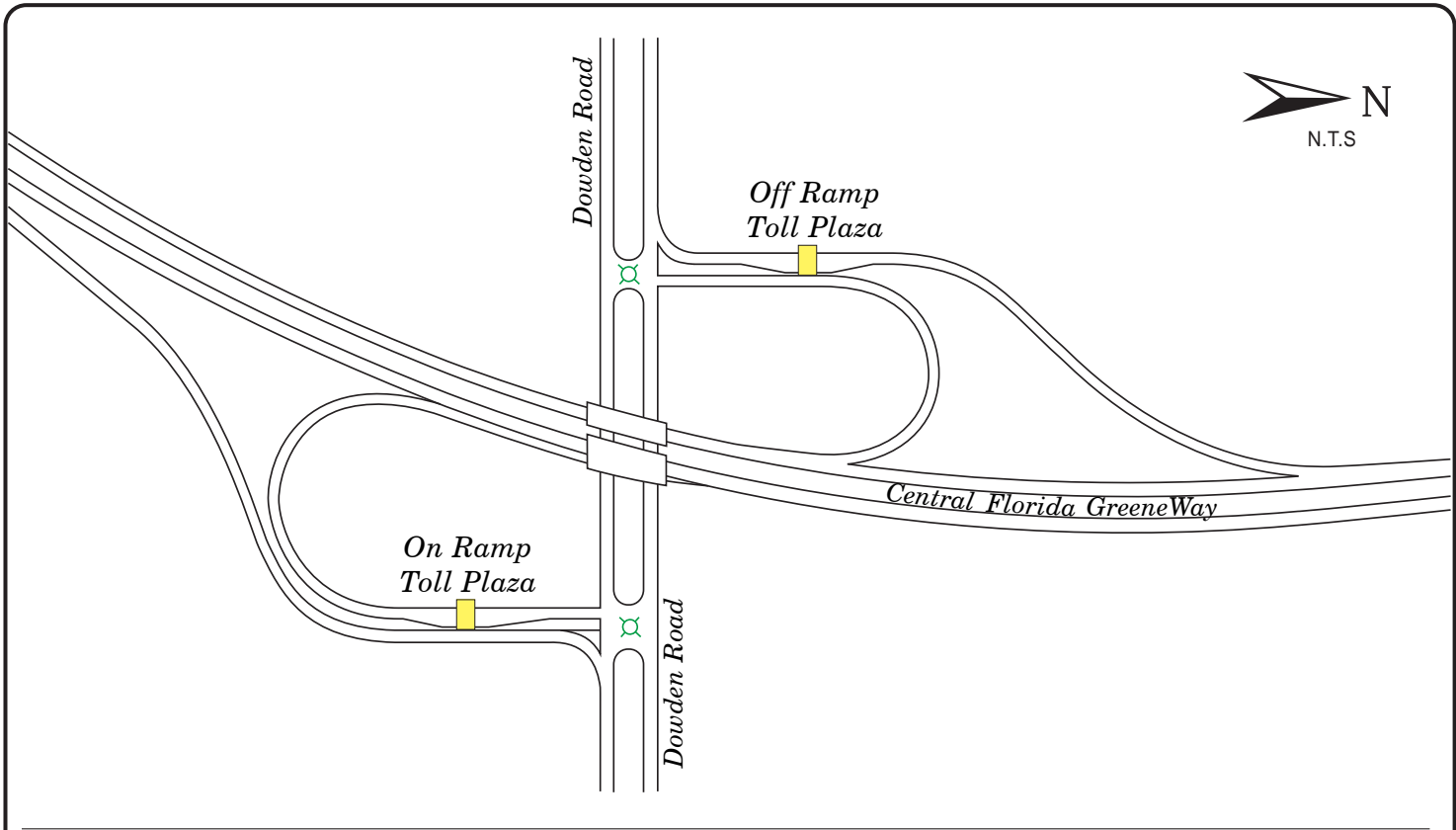

DOWDEN ROAD  
OFF RAMP

DOWDEN ROAD  
ON RAMP

Reports to Boggy Creek Mainline Toll Plaza

FARE STRUCTURE ALL VEHICLES	
Cash	Electronic
\$ 0.75	\$ 0.55

\* Changeable Message Sign

Note: All Changeable Message Signs (CMS) can display three messages: EXACT COINS, CHANGE RECEIPTS, E-PASS ONLY

T:\DOCEANODOCEA MANUAL\STall Facilities Reference Book\2016 Toll Manual - 3/10/16-CP

**To SR 528 (Beachline)  
Orlando International Airport  
& I-4 (Walt Disney World)**

*Next Interchange: Lee Vista Boulevard  
Next Mainline Plaza: Boggy Creek Mainline  
Next Ramp Plaza: Lee Vista Boulevard  
NB-OFF/SB-ON*

**To SR 408 (East-West  
Expressway, SR 50 & Sanford)**

*Next Interchange: Curry Ford Road  
Next Mainline Plaza: University Mainline  
Next Ramp Plaza: Curry Ford Road  
NB-ON/SB-OFF*

Admin.  
Bldg.

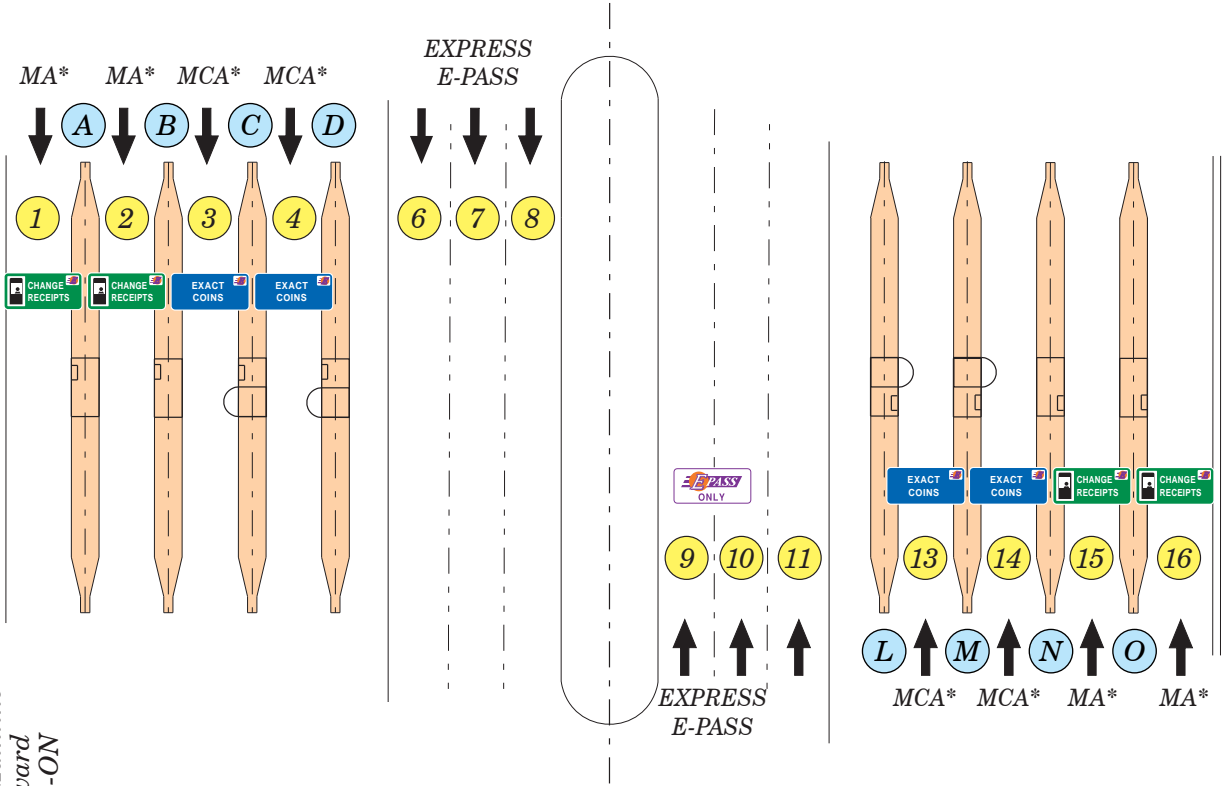

**FARE STRUCTURE**

	Cash	Electronic
2 Axles	\$ 1.00	\$ 0.82
3 Axles	\$ 1.75	\$ 1.64
4 Axles	\$ 2.00	\$ 1.91
5 Axles or more	\$ 2.50	\$ 2.46

**LANES OF EQUIPMENT**

- 6 Express E-PASS (E-PASS only)
- 4 Booths with Automatic Coin Machines with E-PASS (MCA)
- 4 Manned Booths with E-PASS (MA)
- \* Changeable Message Sign

*Note: All Changeable Message Signs (CMS) can display three messages: EXACT COINS, CHANGE RECEIPTS, E-PASS ONLY*

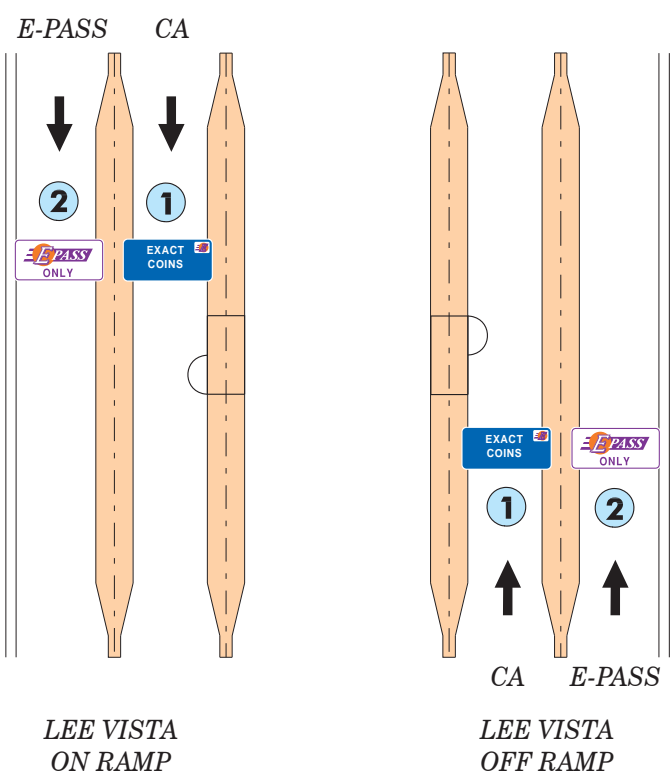
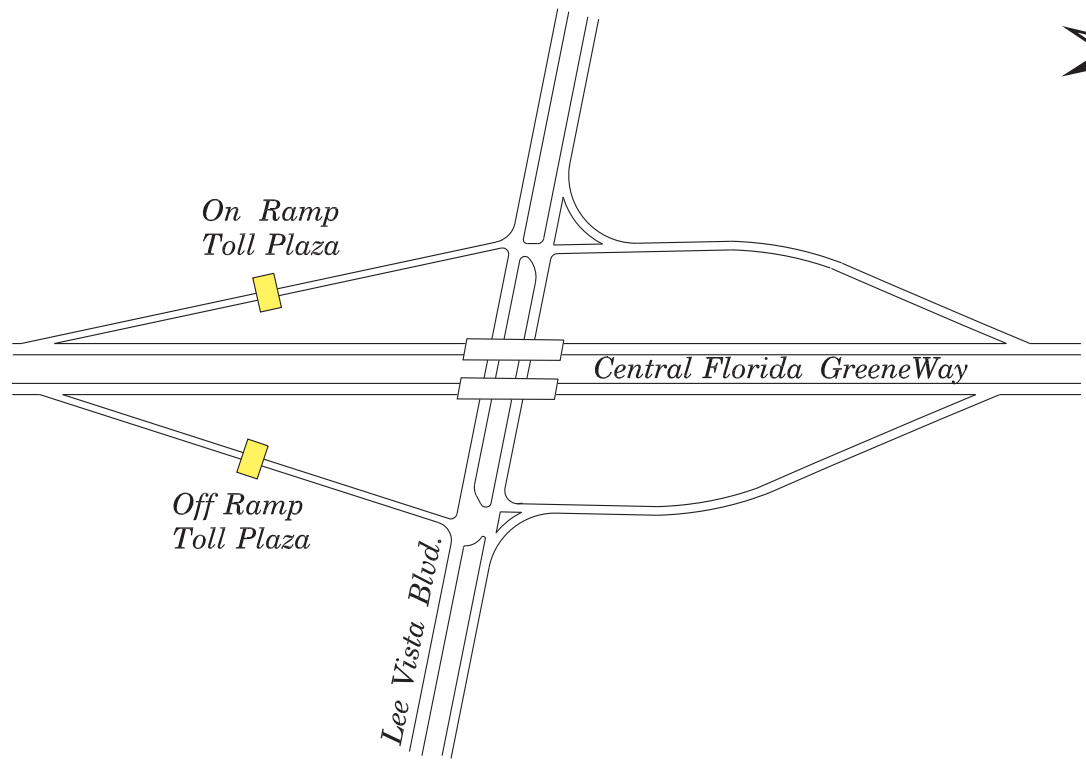

FARE STRUCTURE ALL VEHICLES	
Cash	Electronic
\$ 0.75	\$ 0.55

LEE VISTA  
ON RAMP

LEE VISTA  
OFF RAMP

Reports to Curry Ford Mainline Toll Plaza

T:\DOCEAN\DOCEA MANUAL\ST\Toll Facilities Reference Book\2016 Toll Manual - 3/10/16-CP

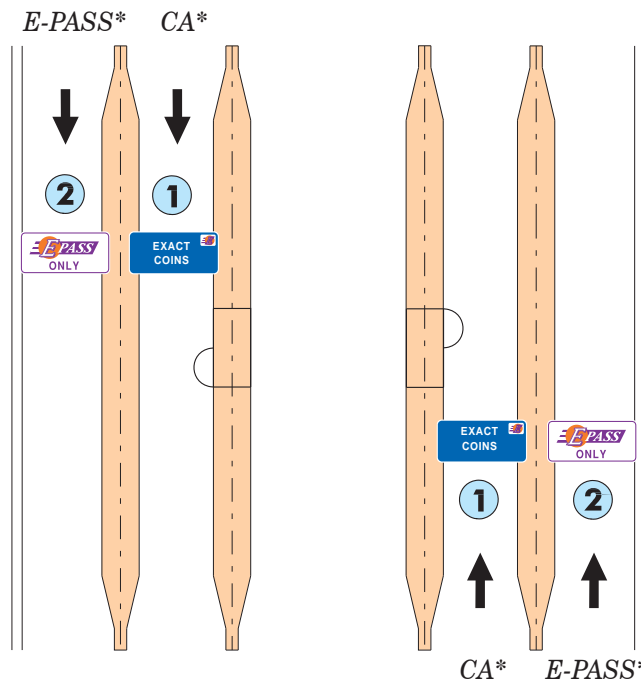
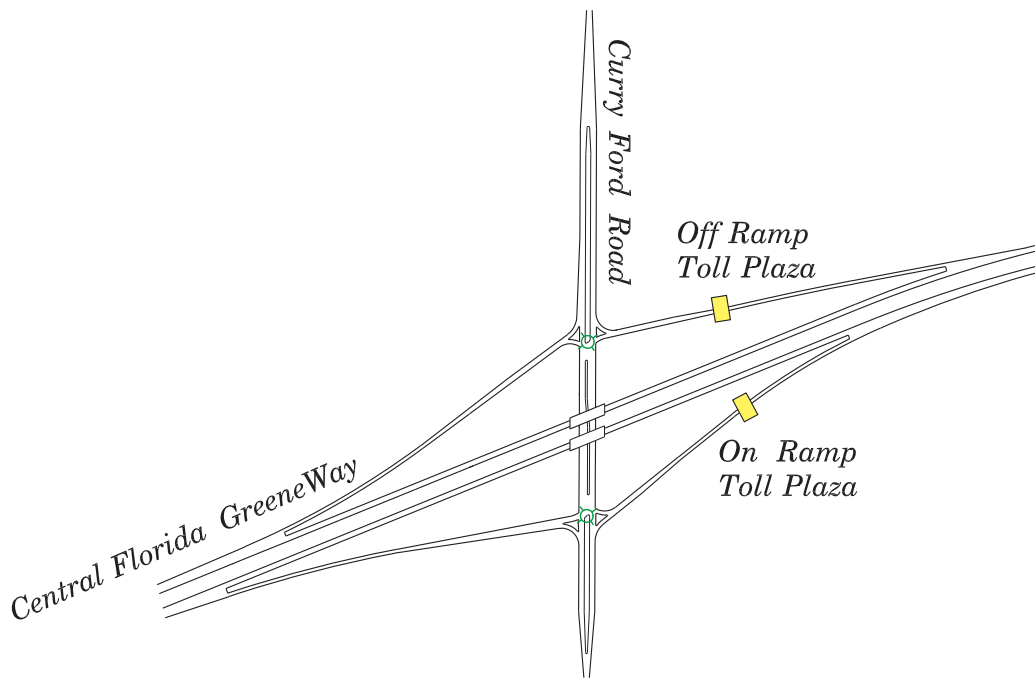

CURRY FORD  
OFF RAMP

CURRY FORD  
ON RAMP

Reports to Curry Ford Mainline Toll Plaza

FARE STRUCTURE ALL VEHICLES	
Cash	Electronic
\$ 0.75	\$ 0.55

\* Changeable Message Sign

Note: All Changeable Message Signs (CMS) can display three messages: EXACT COINS, CHANGE RECEIPTS, E-PASS ONLY

↑  
**To US 17, 92 & US 441**  
 Next Interchange: University Boulevard  
 Next Mainline Plaza: Lake Jessup Mainline (Turnpike)  
 Next Ramp Plaza: Aloma Ave. (Turnpike)  
 NB-OFF/SB-ON

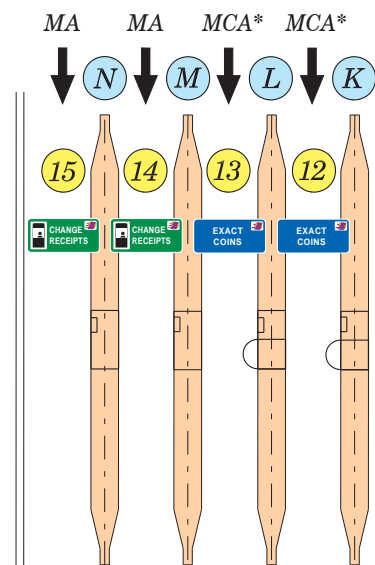

↓  
**To SR 50 (Colonial Drive), SR 408 & SR 528**  
 Next Interchange: SR 50  
 Next Mainline Plaza: Curry Ford Mainline  
 Next Ramp Plaza: SR 50 (Colonial Drive)  
 NB-OFF/SB-ON

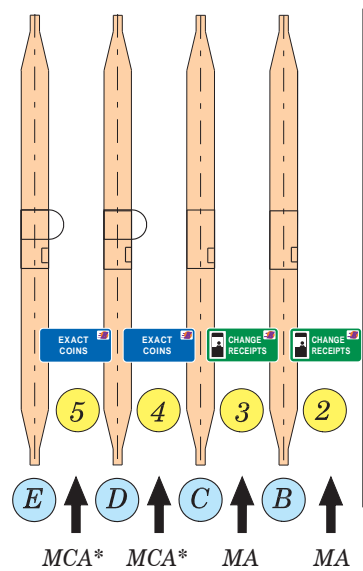
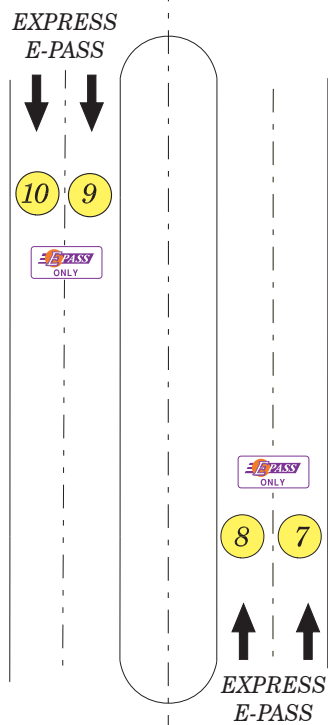

<u>FARE STRUCTURE</u>		
	<u>Cash</u>	<u>Electronic</u>
2 Axles	\$ 1.00	\$ 0.82
3 Axles	\$ 1.75	\$ 1.64
4 Axles	\$ 2.00	\$ 1.91
5 Axles or more	\$ 2.50	\$ 2.46

- LANES OF EQUIPMENT
- 4 Express E-PASS (E-PASS only)
  - 4 Booths with Automated Coin Machines with E-PASS (MCA)
  - 4 Manned Booths with E-PASS (MA)
  - \* Changeable Message Sign

Note: All Changeable Message Signs (CMS) can display three messages: EXACT COINS, CHANGE RECEIPTS, E-PASS ONLY

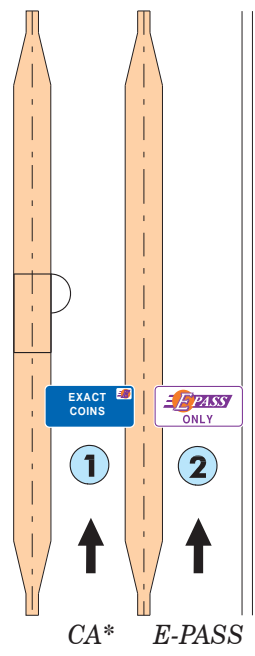
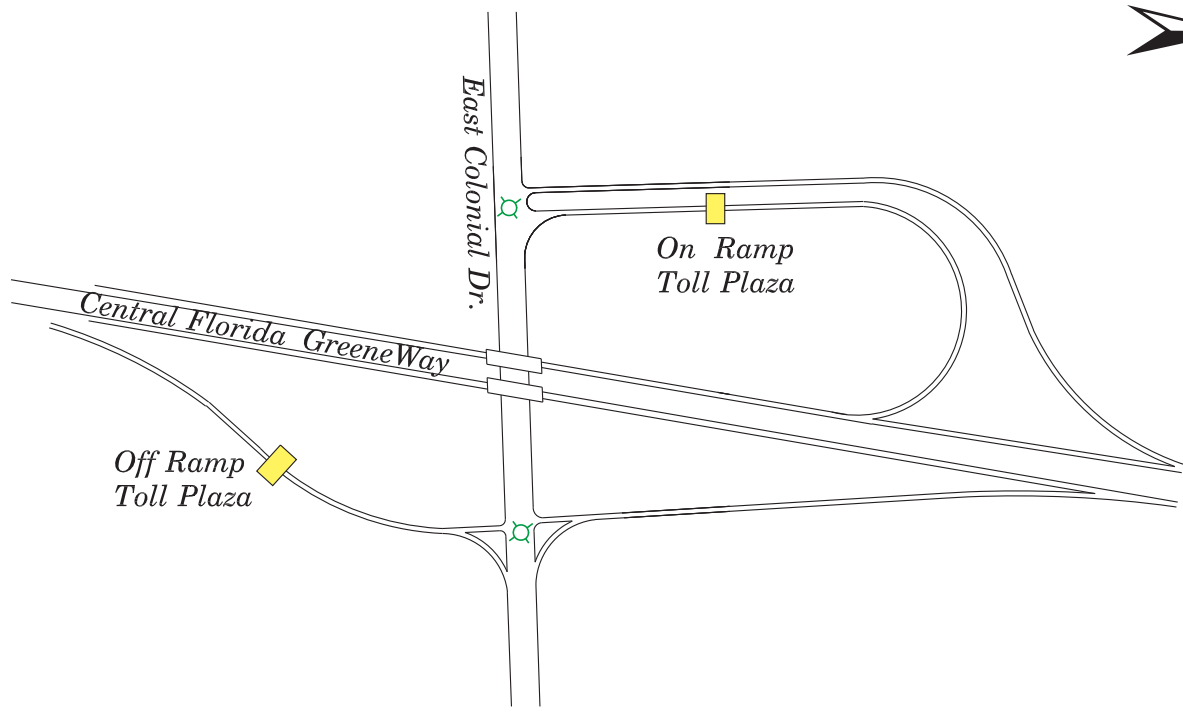

EAST COLONIAL  
ON RAMP

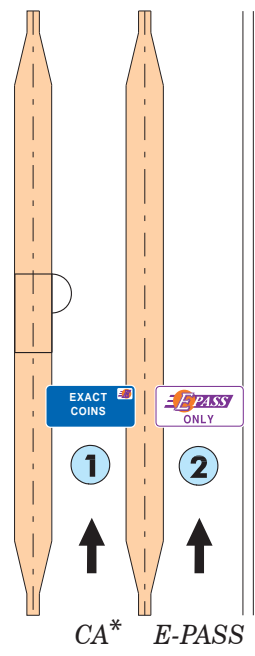

EAST COLONIAL  
OFF RAMP

Reports to University Mainline Toll Plaza

FARE STRUCTURE ALL VEHICLES	
Cash	Electronic
\$ 0.75	\$ 0.55

\* Changeable Message Sign

Note: All Changeable Message Signs (CMS) can display three messages: EXACT COINS, CHANGE RECEIPTS, E-PASS ONLY

T:\00CEANODOCEA MANUAL\ST01 Toll Facilities Reference Book\2016 Toll Manual - 3/10/16-CP

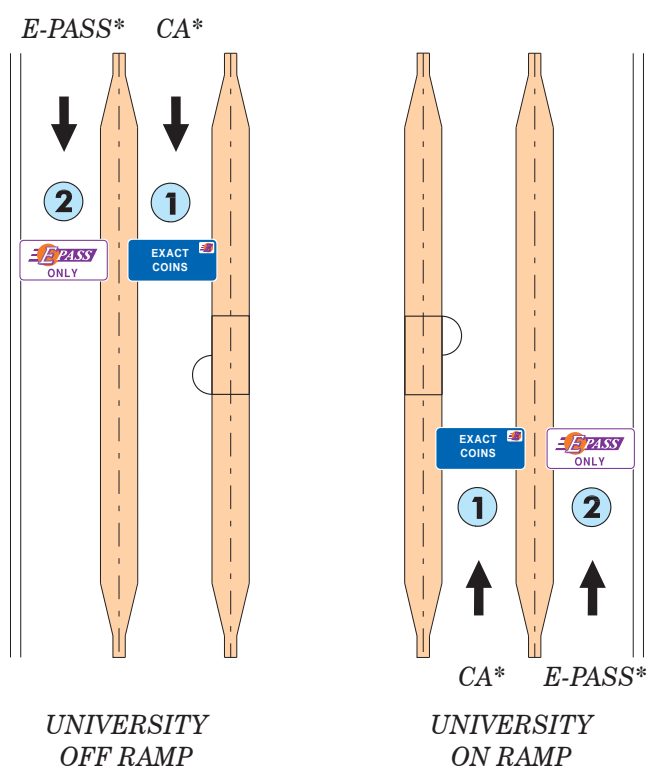
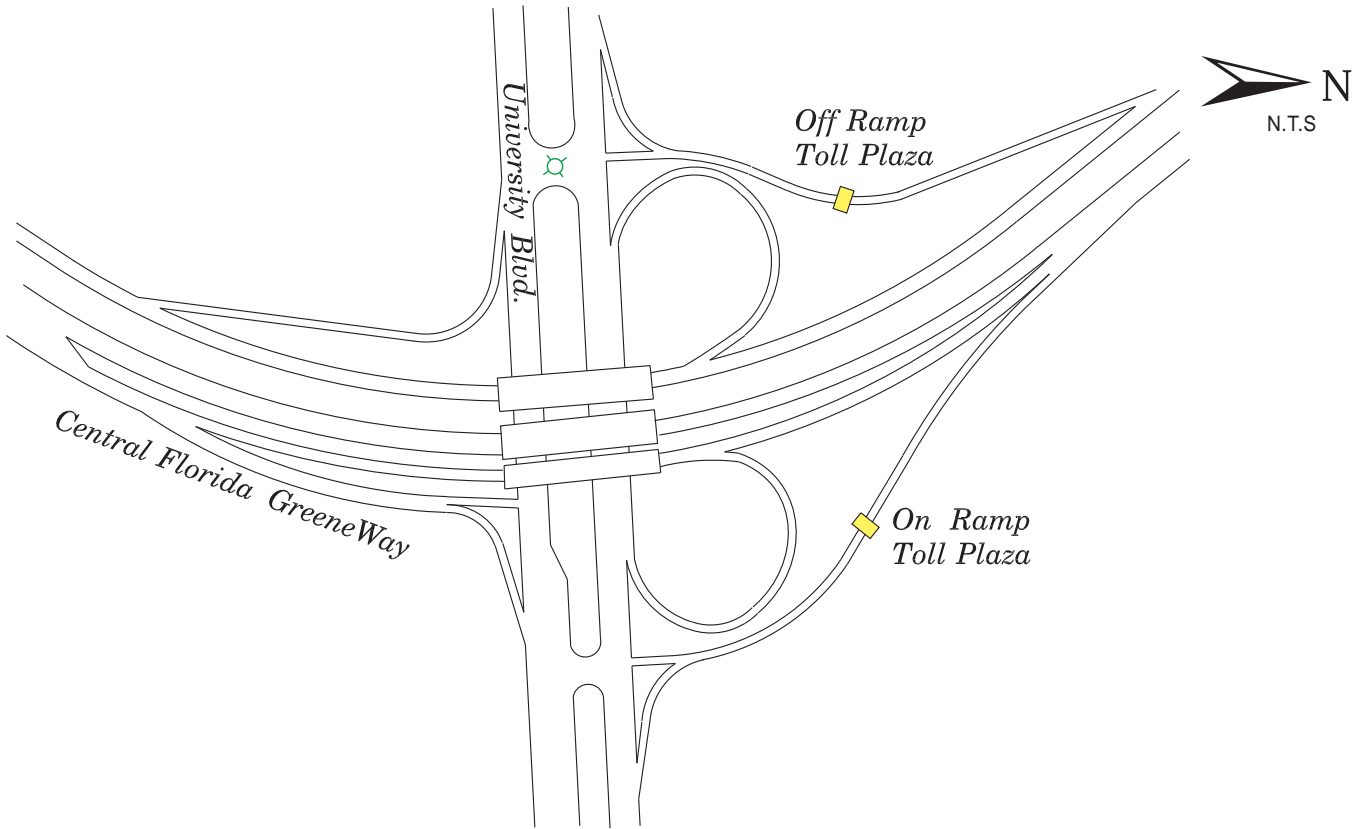

FARE STRUCTURE ALL VEHICLES	
Cash	Electronic
\$ 0.75	\$ 0.55

\* Changeable Message Sign

Reports to University Mainline Toll Plaza

Note: All Changeable Message Signs (CMS) can display three messages: EXACT COINS, CHANGE RECEIPTS, E-PASS ONLY

T:\00CEANOCEA MANUAL\Stall Facilities Reference Book\2016 Toll Manual - 3/10/16-CP



# Western Beltway



## Mainline Toll Plazas and Associated Tolloed Ramps

LEGEND

*For Lane Designations for all Plazas*

*CA - Exact Coin with E-PASS*

*MA - Change Receipts (Manned) with E-PASS*

*MCA - Booth with Manual Lane Terminal,  
Automatic Coin Machine and E-PASS*

**To Florida's Turnpike, S.R. 50 & Apopka (US 441)**  
 Next Interchange: C.R. 535  
 Next Mainline Plaza: Forest Lake Mainline  
 Next Ramp Plaza: C.R. 535  
 NB-ON / SB-OFF

**To New Independence Parkway, U.S. 192 & I-4**  
 Next Interchange: New Independence Pkwy.  
 Next Mainline Plaza: SR 429 South Mainline (Turnpike)  
 Next Ramp Plaza: New Independence Pkwy.  
 SB-ON / NB-OFF

Admin.  
Bldg.

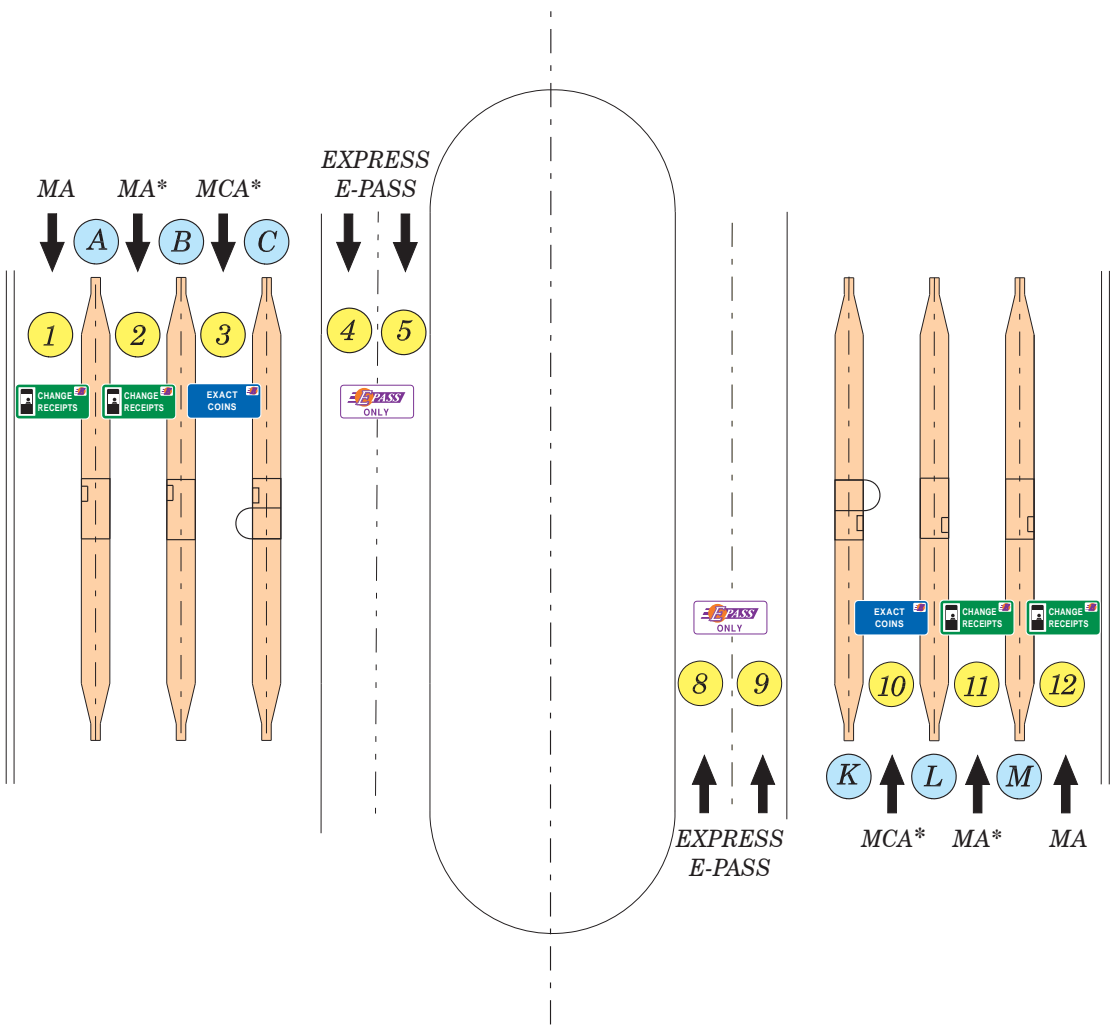

**FARE STRUCTURE**

	<u>Cash</u>	<u>Electronic</u>
2 Axles	\$ 1.50	\$ 1.37
3 Axles	\$ 2.00	\$ 1.91
4 Axles	\$ 2.50	\$ 2.46
5 Axles or more	\$ 3.00	\$ 3.00

- LANES OF EQUIPMENT**
- 4 Manned Booths with E-PASS (MA)
  - 2 Booths with ACM and E-PASS
  - 4 Express E-PASS (E-PASS only)
  - \* Changeable Message Sign

*Note: All Changeable Message Signs (CMS) can display three messages: EXACT COINS, CHANGE RECEIPTS, E-PASS ONLY*

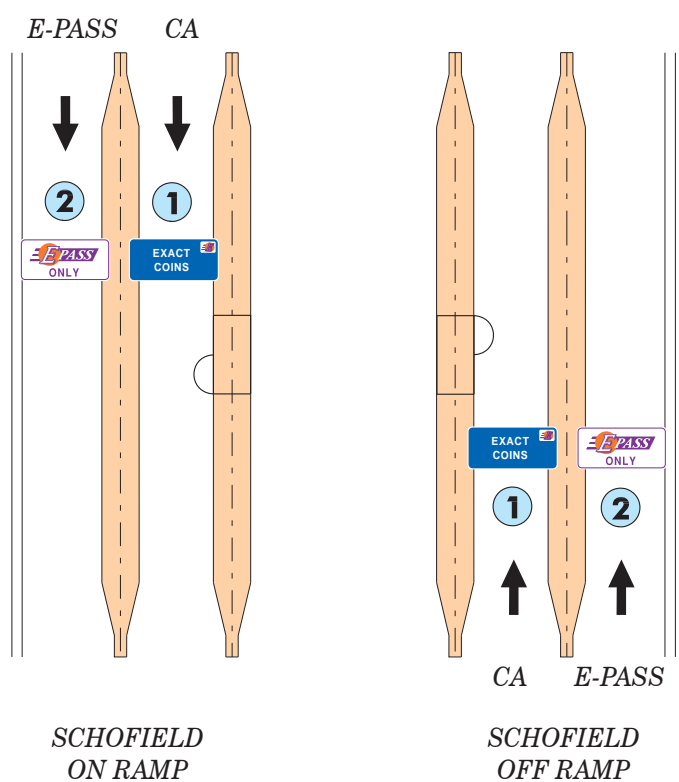
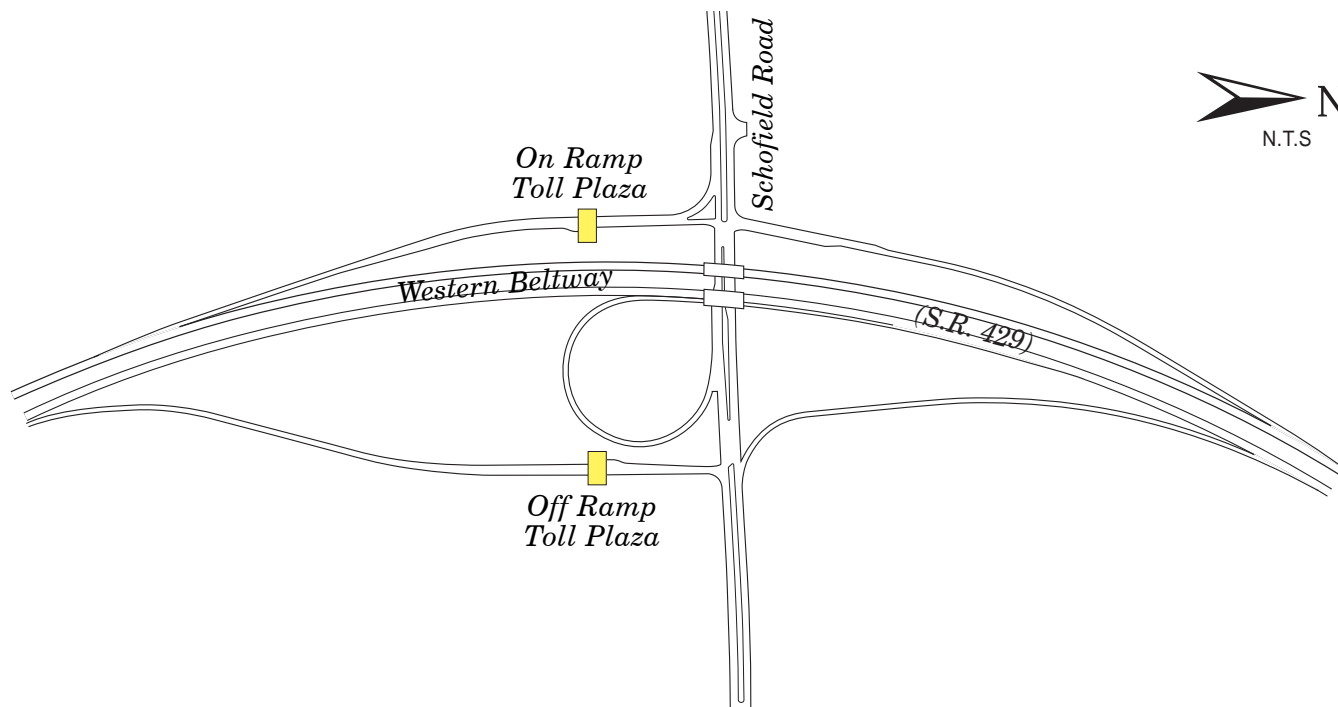

FARE STRUCTURE ALL VEHICLES	
Cash	Electronic
\$ 0.75	\$ 0.50

Reports to Independence Mainline Toll Plaza

T:\DOCEANODOCEA MANUAL\Still Facilities Reference Book\2016 Toll Manual - 3/10/16-CP

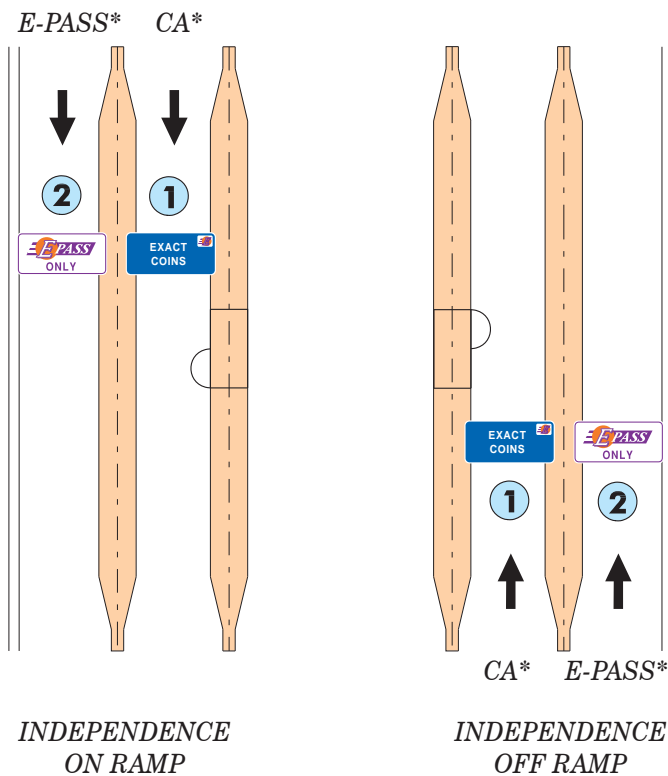
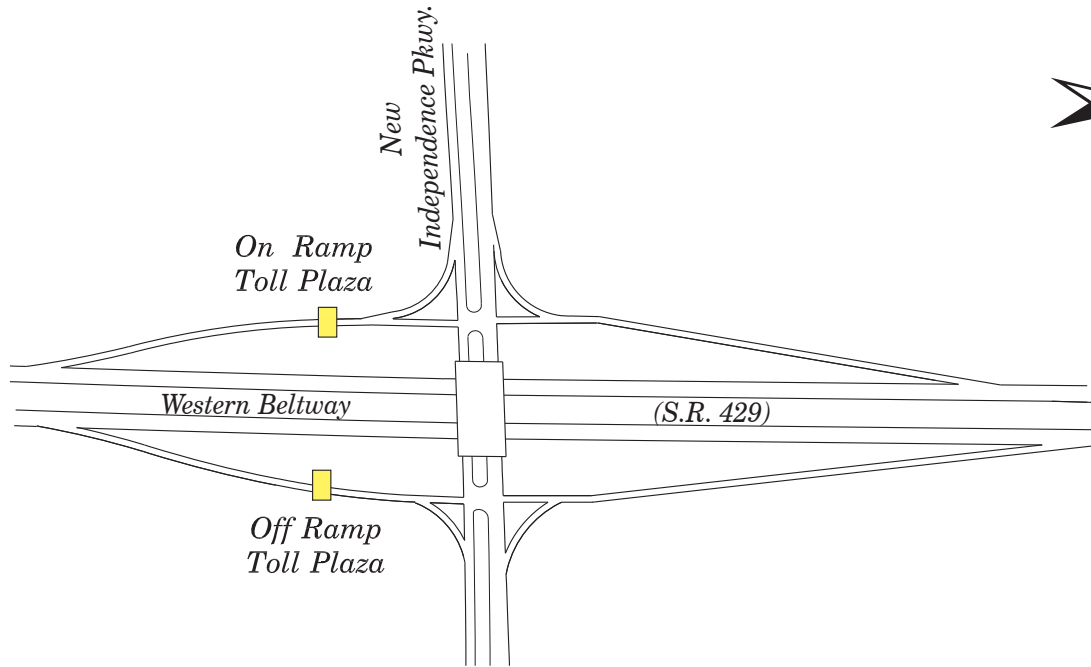

FARE STRUCTURE ALL VEHICLES	
Cash	Electronic
\$ 1.00	\$ 0.82

\* Changeable Message Sign

Note: All Changeable Message Signs (CMS) can display three messages: EXACT COINS, CHANGE RECEIPTS, E-PASS ONLY

Reports to Independence Mainline Toll Plaza

T:\DOCEANODOCEA MANUAL\ST01 Toll Facilities Reference Book\2016 Toll Manual - 3/10/16-CP

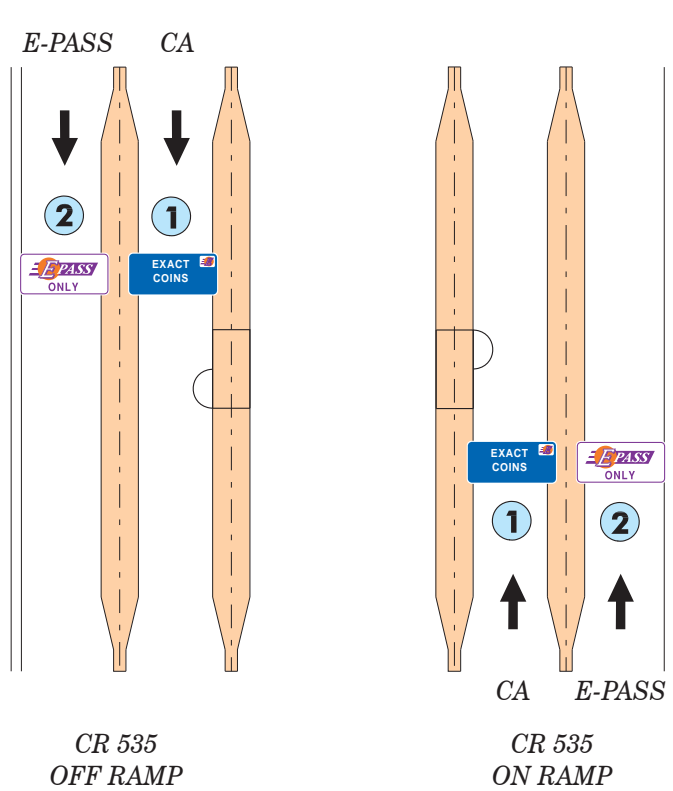
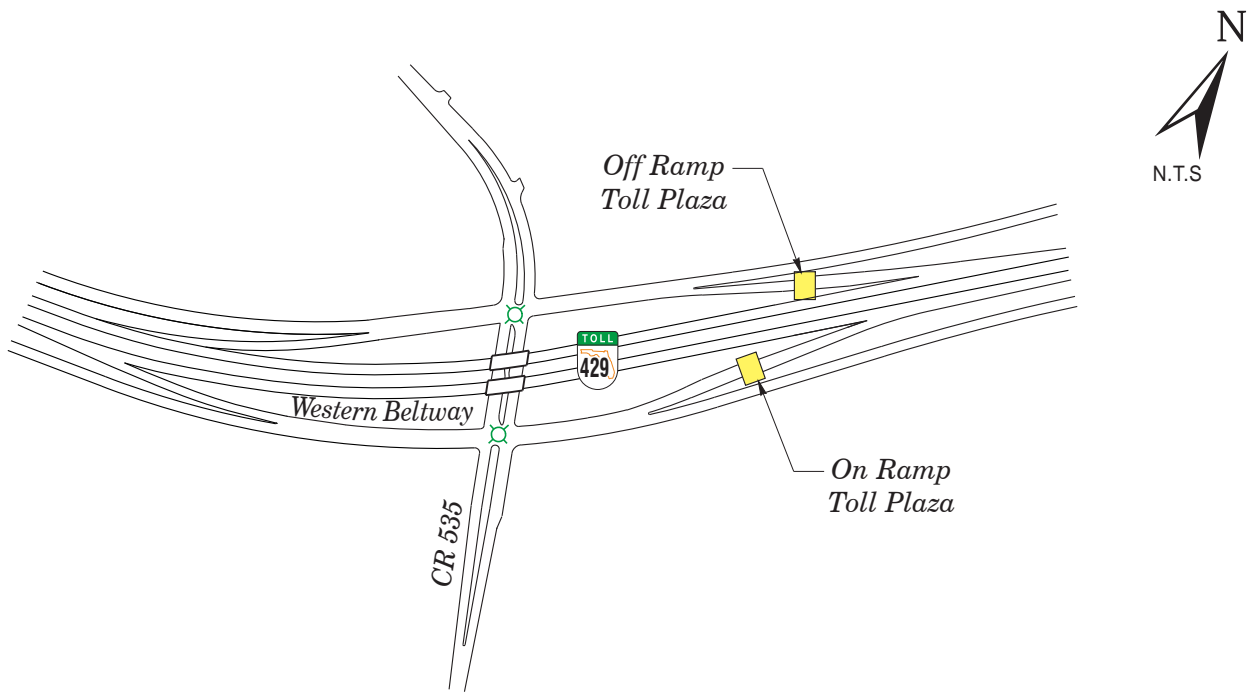

FARE STRUCTURE ALL VEHICLES	
Cash	Electronic
\$ 0.75	\$ 0.55

Reports to Independence Mainline Toll Plaza

T:\00CEANOCEA MANUAL\Still Facilities Reference Book\2016 Toll Manual - 3/10/16-CP

↑  
**To US 441, Apopka**  
 Next Interchange: CR 437A  
 Next Mainline Plaza: None  
 Next Ramp Plaza: None

↓  
**To SR 50 & Florida's Turnpike**  
 Next Interchange: West Rd.  
 Next Mainline Plaza: Independence Mainline  
 Next Ramp Plaza: West Rd.  
 NB-OFF/SB-ON

Admin.  
Bldg.

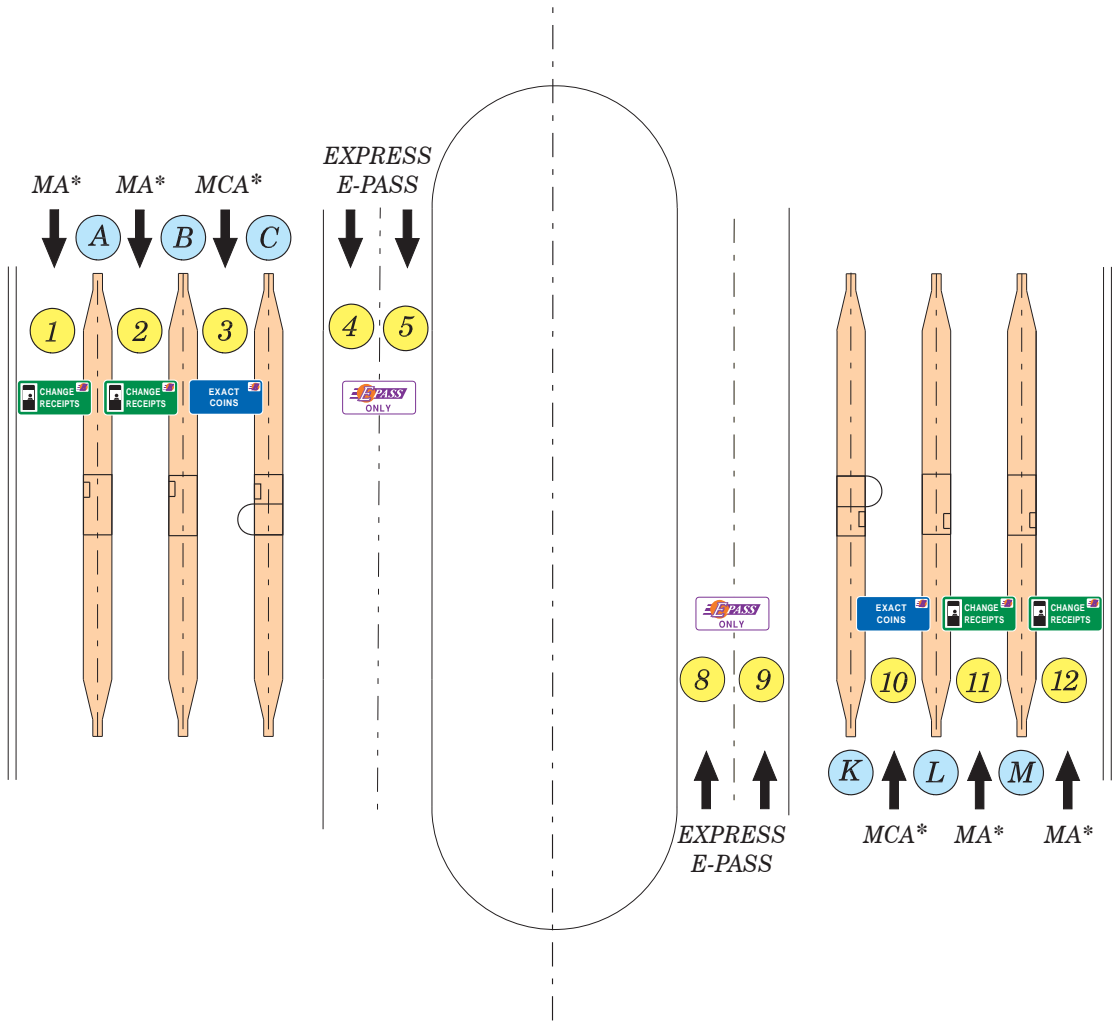

**FARE STRUCTURE**

	Cash	Electronic
2 Axles	\$ 1.50	\$ 1.37
3 Axles	\$ 2.00	\$ 1.91
4 Axles	\$ 2.50	\$ 2.46
5 Axles or more	\$ 3.00	\$ 3.00

- LANES OF EQUIPMENT**
- 4 Manned Booth with E-PASS (MA)
  - 2 Booths with ACM and E-PASS
  - 4 Express E-PASS (E-PASS only)
  - \* Changeable Message Sign

Note: All Changeable Message Signs (CMS) can display three messages: EXACT COINS, CHANGE RECEIPTS, E-PASS ONLY

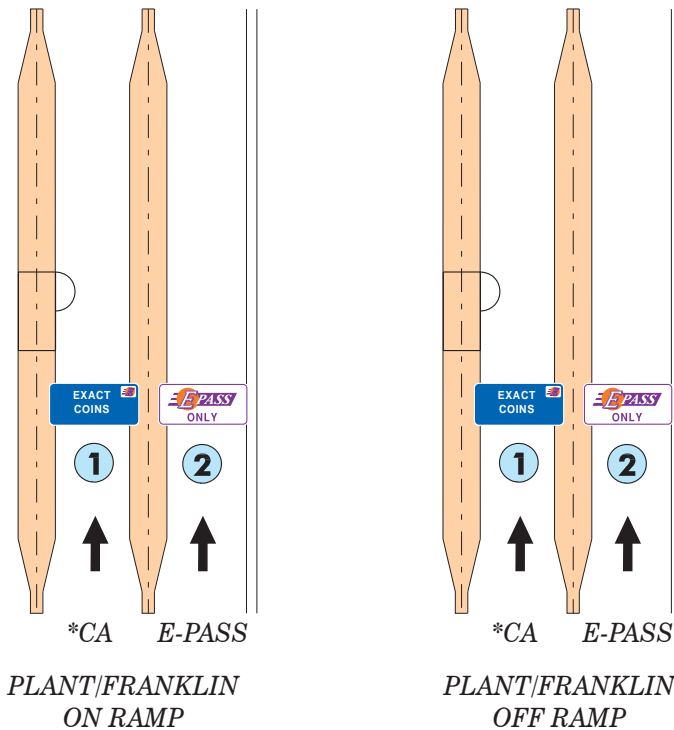
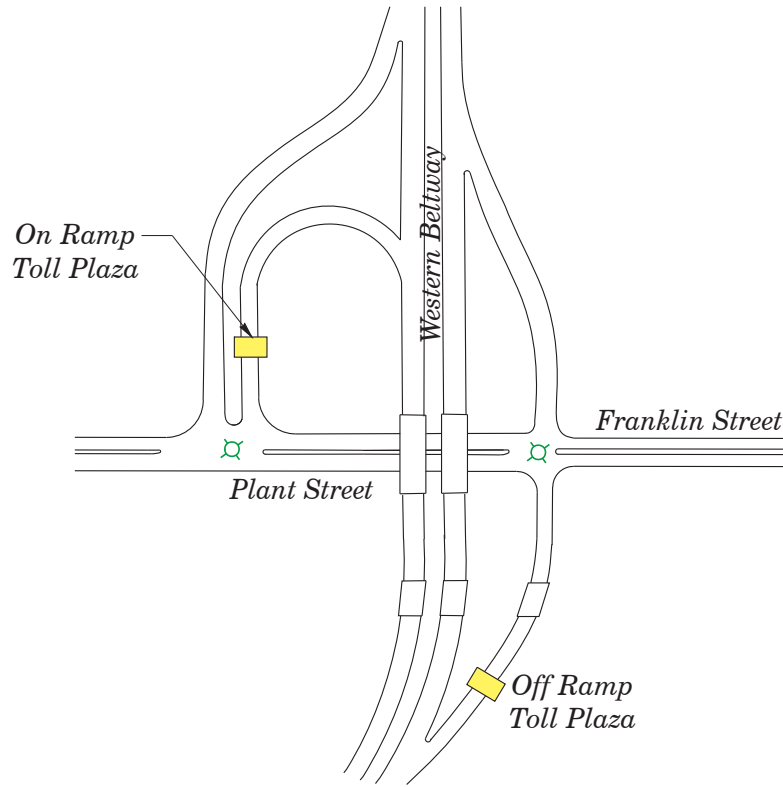

FARE STRUCTURE ALL VEHICLES	
Cash	Electronic
\$ 0.50	\$ 0.28

\* Changeable Message Sign

Note: All Changeable Message Signs (CMS) can display three messages: EXACT COINS, CHANGE RECEIPTS, E-PASS ONLY

Reports to Forest Lake Mainline Toll Plaza

T:\00CEANOCEA MANUAL\Stall Facilities Reference Book\2016 Toll Manual - 3/10/16-CP

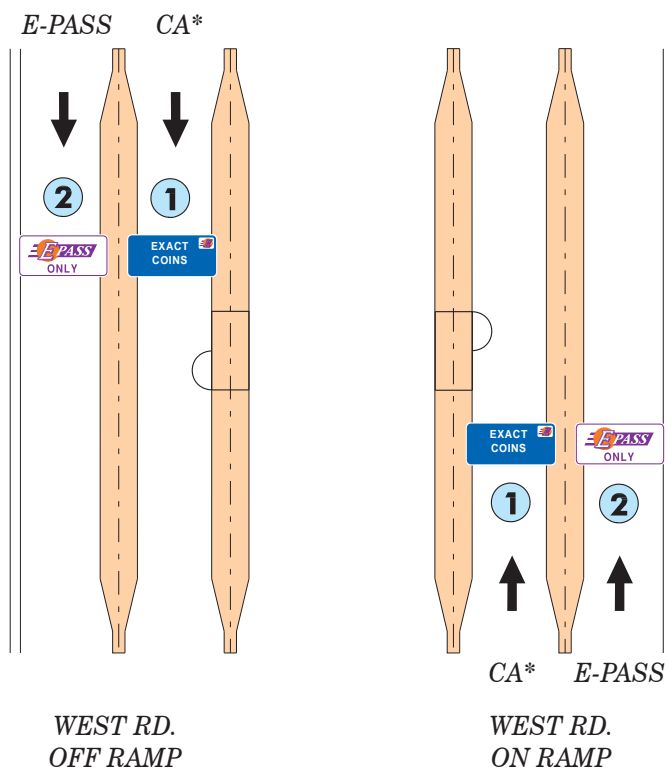
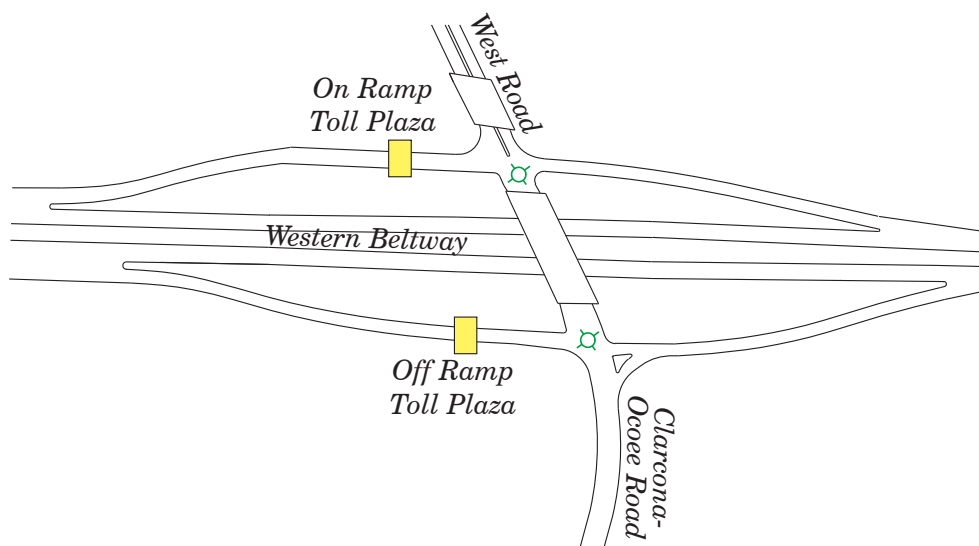

FARE STRUCTURE ALL VEHICLES	
Cash	Electronic
\$ 1.00	\$ 0.82

\* Changeable Message Sign

Note: All Changeable Message Signs (CMS) can display three messages: EXACT COINS, CHANGE RECEIPTS, E-PASS ONLY

Reports to Forest Lake Mainline Toll Plaza

T:\OCEANOCEA MANUAL\STall Facilities Reference Book\2016 Toll Manual - 3/10/16-CP



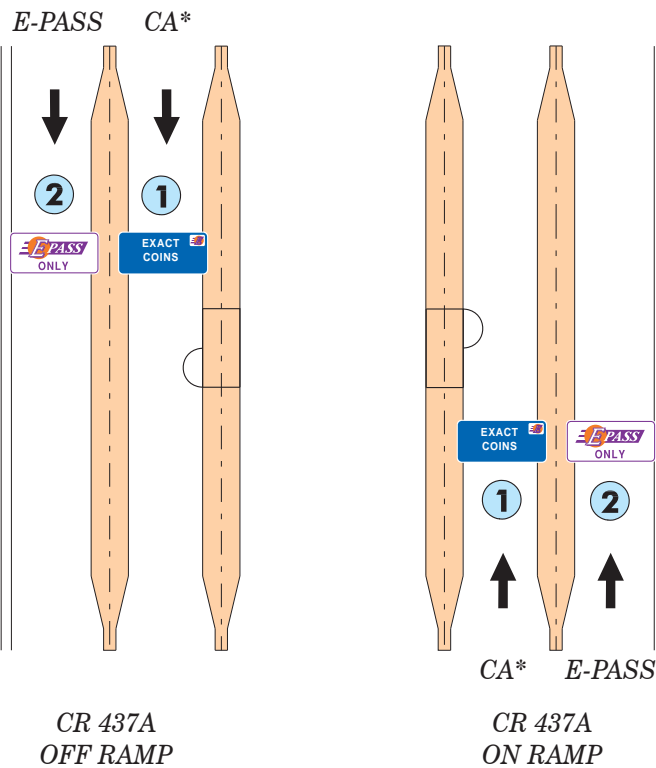
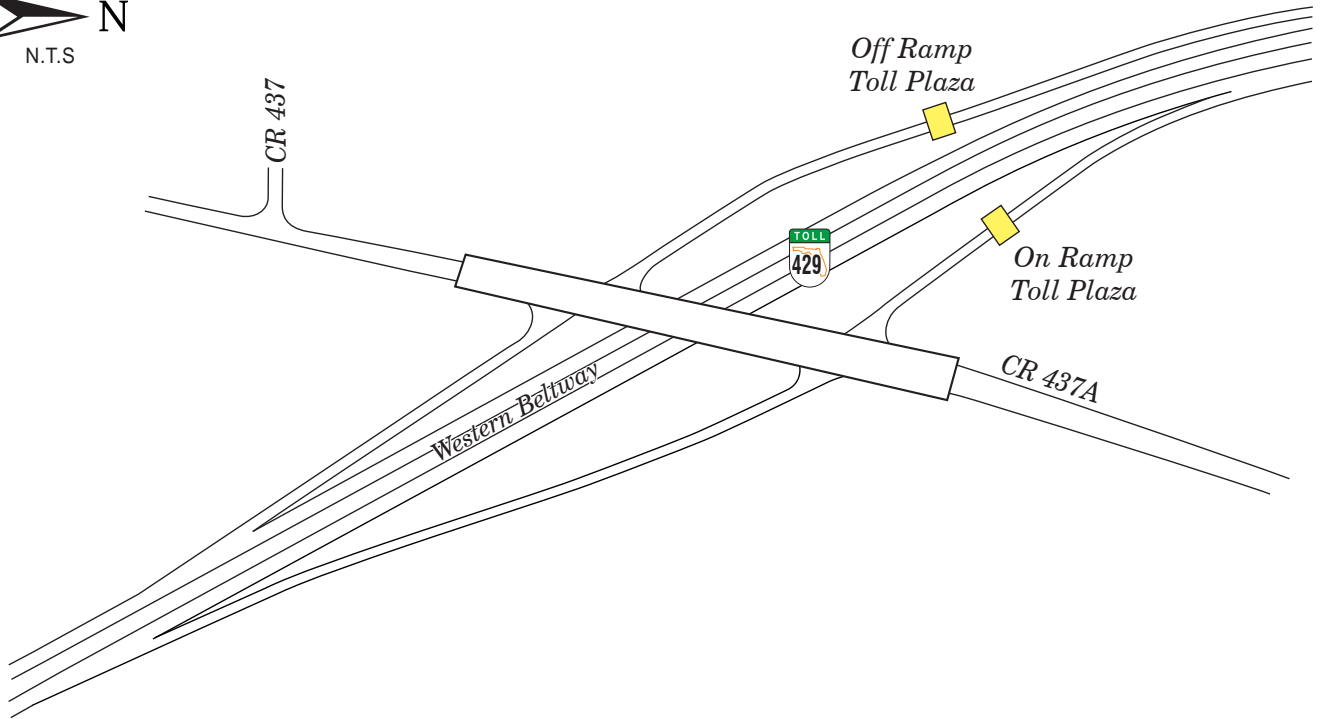

FARE STRUCTURE ALL VEHICLES	
Cash	Electronic
\$ 0.75	\$ 0.55

\* Changeable Message Sign

Note: All Changeable Message Signs (CMS) can display three messages: EXACT COINS, CHANGE RECEIPTS, E-PASS ONLY

Reports to Forest Lake Mainline Toll Plaza

T:\00CEANOCEA MANUAL\ST01 Toll Facilities Reference Book\2016 Toll Manual - 3/10/16-CP

# Beachline Expressway



## Mainline Toll Plazas and Associated Tolled Ramps

### LEGEND

*For Lane Designations for all Plazas*

*CA - Exact Coin with E-PASS*

*MA - Change Receipts (Manned) with E-PASS*

*MCA - Booth with Manual Lane Terminal,  
Automatic Coin Machine and E-PASS*

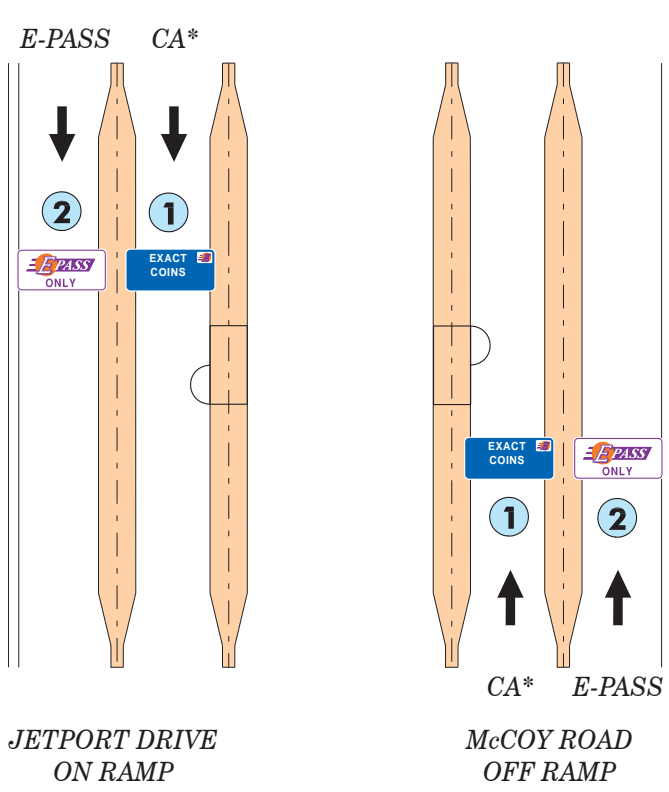
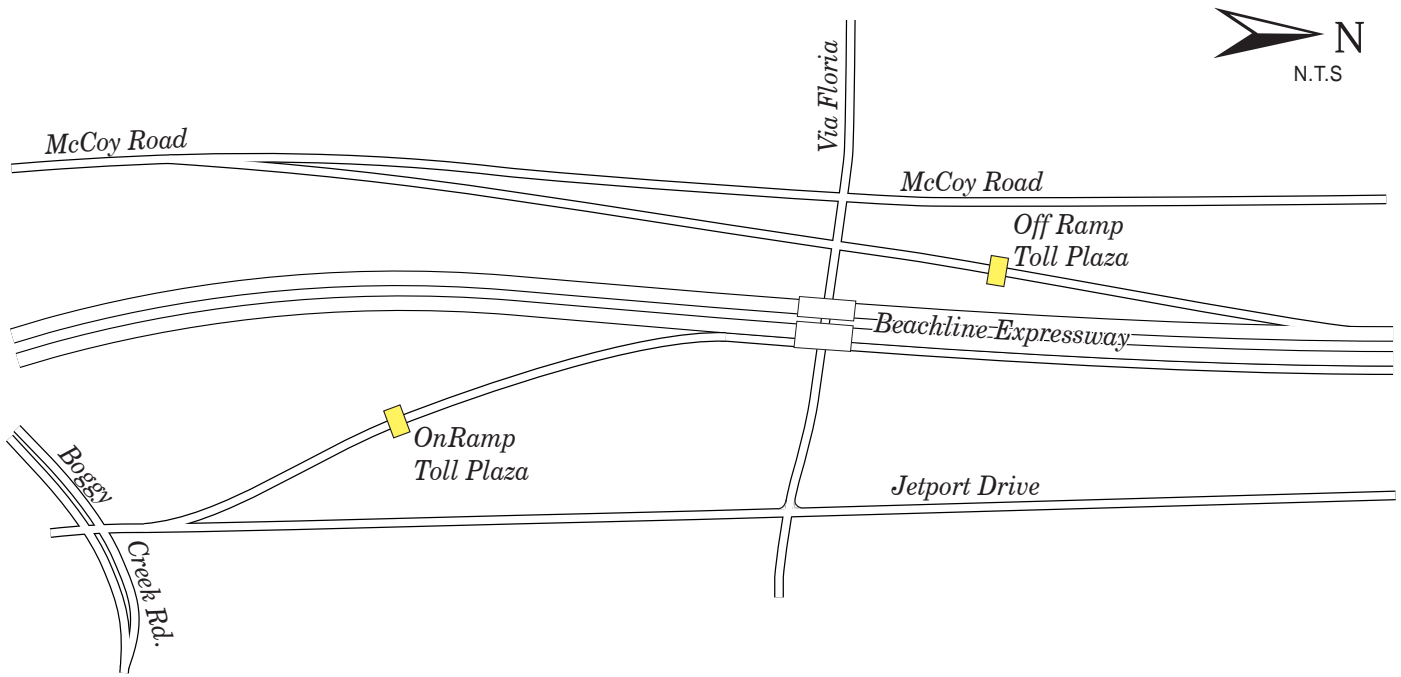

Reports to Beachline Mainline Toll Plaza

FARE STRUCTURE ALL VEHICLES	
Cash	Electronic
\$ 1.25	\$ 1.09

\* Changeable Message Sign

Note: All Changeable Message Signs (CMS) can display three messages: EXACT COINS, CHANGE RECEIPTS, E-PASS ONLY

T:\00CEANOCCEA MANUAL\Still Facilities Reference Book\2016 Toll Manual - 3/10/16-CP

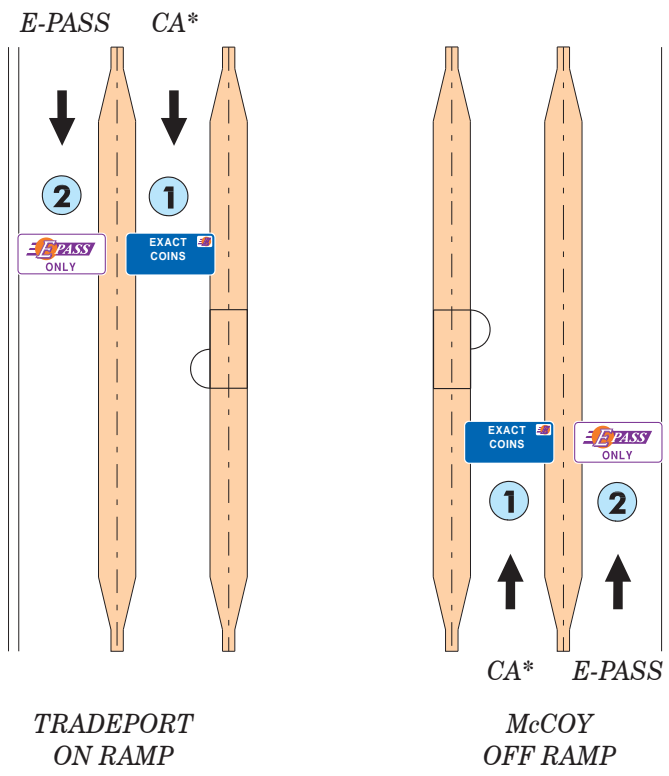
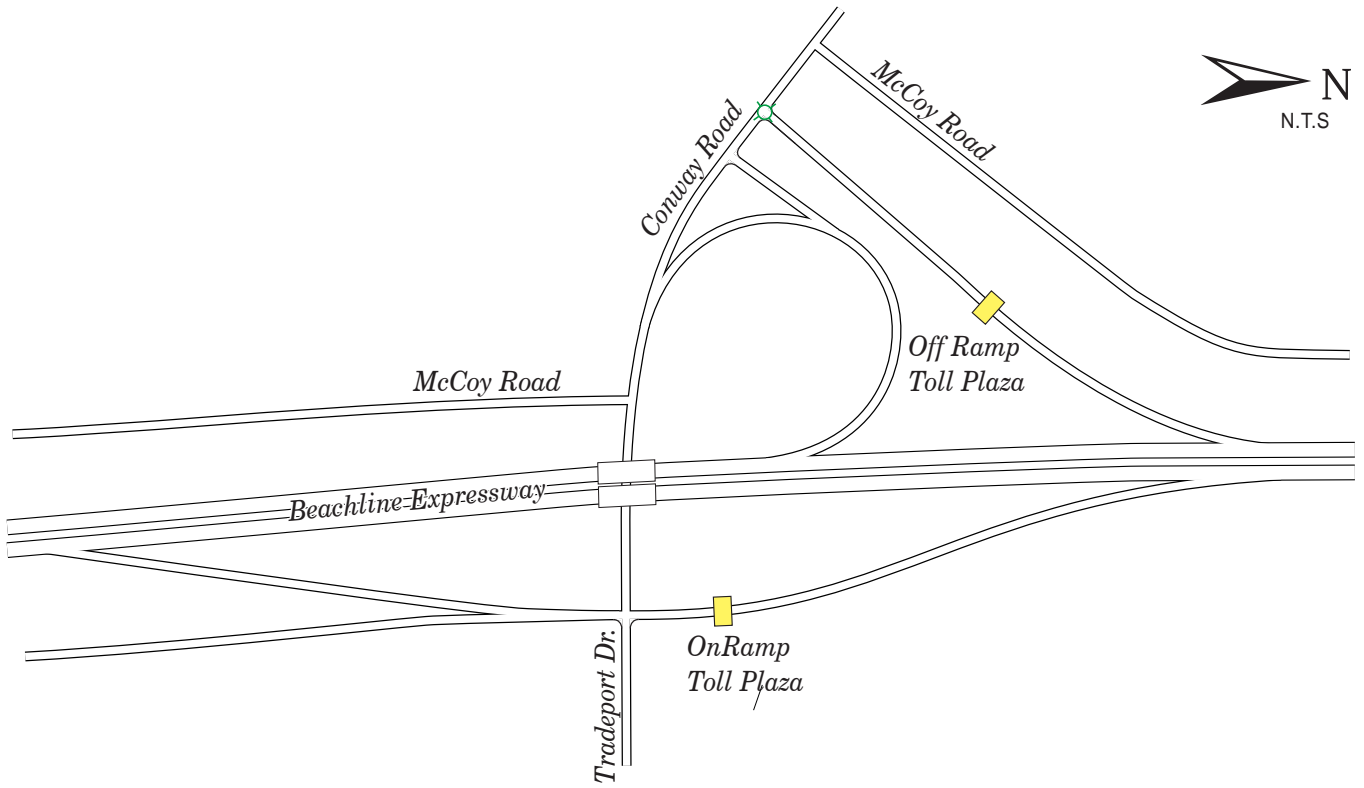

FARE STRUCTURE ALL VEHICLES	
Cash	Electronic
\$ 1.25	\$ 1.09

\* Changeable Message Sign

Note: All Changeable Message Signs (CMS) can display three messages: EXACT COINS, CHANGE RECEIPTS, E-PASS ONLY

Reports to Beachline Mainline Toll Plaza

T:\DOCEANODOCEA MANUAL\Still Facilities Reference Book\2016 Toll Manual - 3/10/16-CP

↑  
To SR 520, I-95 & Port Canaveral  
To SR 417 (GreeneWay), SR 436 (Semoran Blvd) & Orlando Int'l Airport  
↓

Next Interchange: ICP Blvd  
Next Mainline Plaza: None  
Next Ramp Plaza: ICP  
EB-ON/WB-OFF

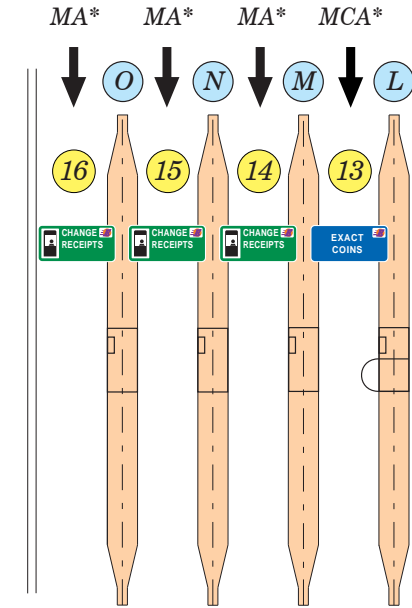

Next Interchange: SR 417 (GreeneWay)  
Next Mainline Plaza: Beachline Airport Mainline  
Next Ramp Plaza: None

EXPRESS  
E-PASS

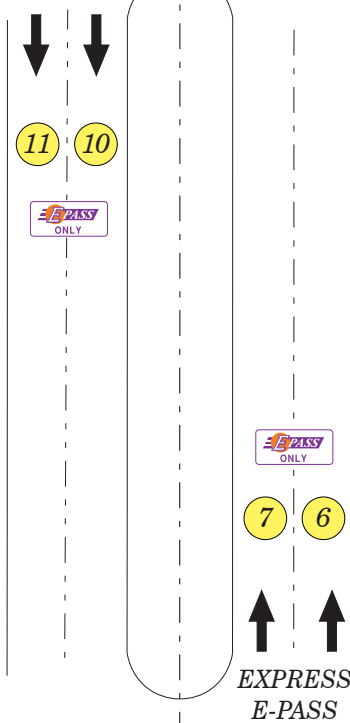

EXPRESS  
E-PASS

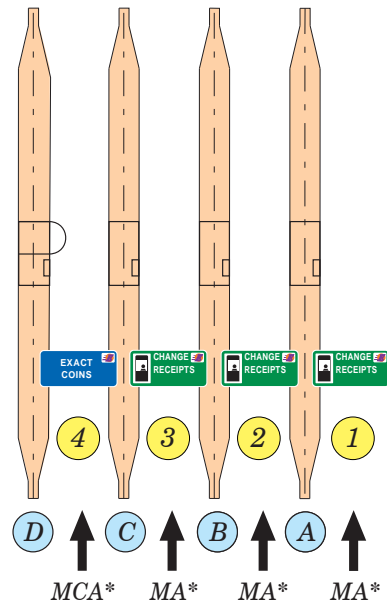

MCA\* MA\* MA\* MA\*

Admin.  
Blg.

Note: All Changeable Message Signs (CMS) can display three messages: EXACT COINS, CHANGE RECEIPTS, E-PASS ONLY

**FARE STRUCTURE**

	Cash	Electronic
2 Axles	\$ 1.00	\$ 0.87
3 Axles	\$ 1.75	\$ 1.71
4 Axles	\$ 2.00	\$ 2.00
5 Axles or more	\$ 2.75	\$ 2.55

**LANES OF EQUIPMENT**

- 6 Manned Booths with E-PASS (MA)
- 2 Booths with ACM's and E-PASS
- 4 Express E-PASS (E-PASS only)
- \* Changeable Message Sign



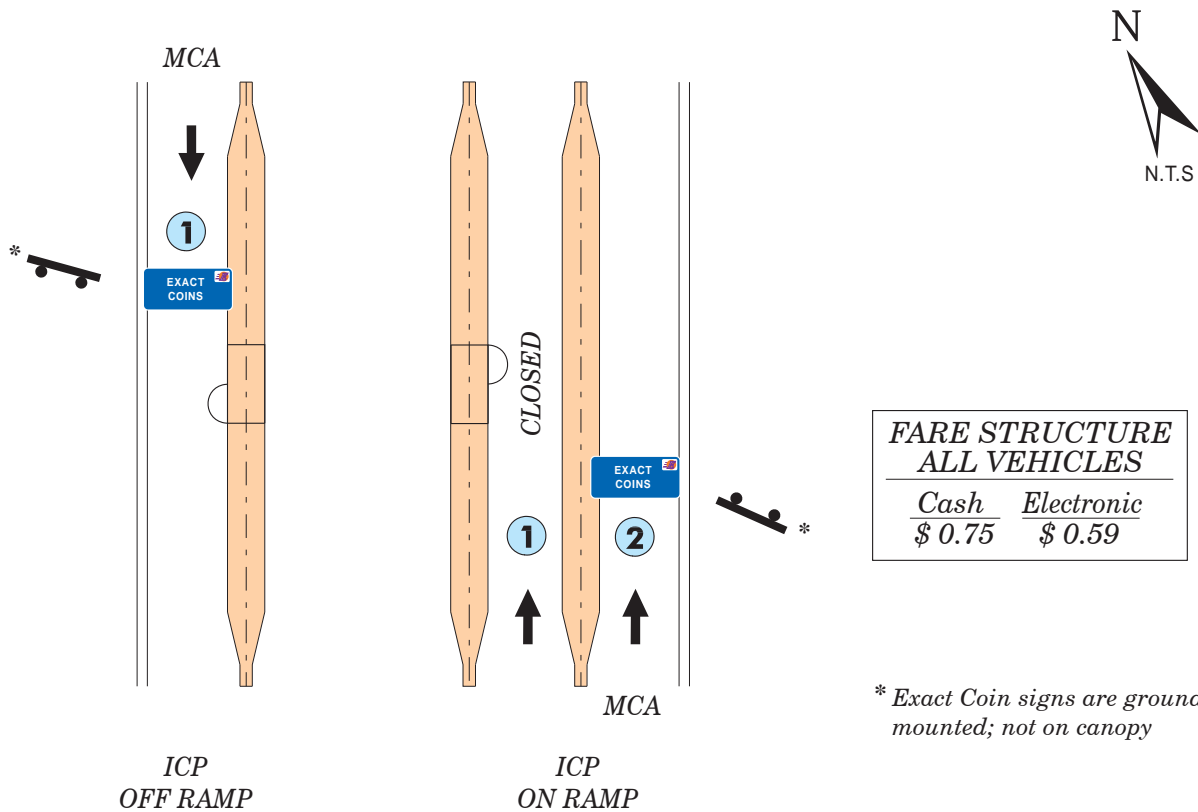
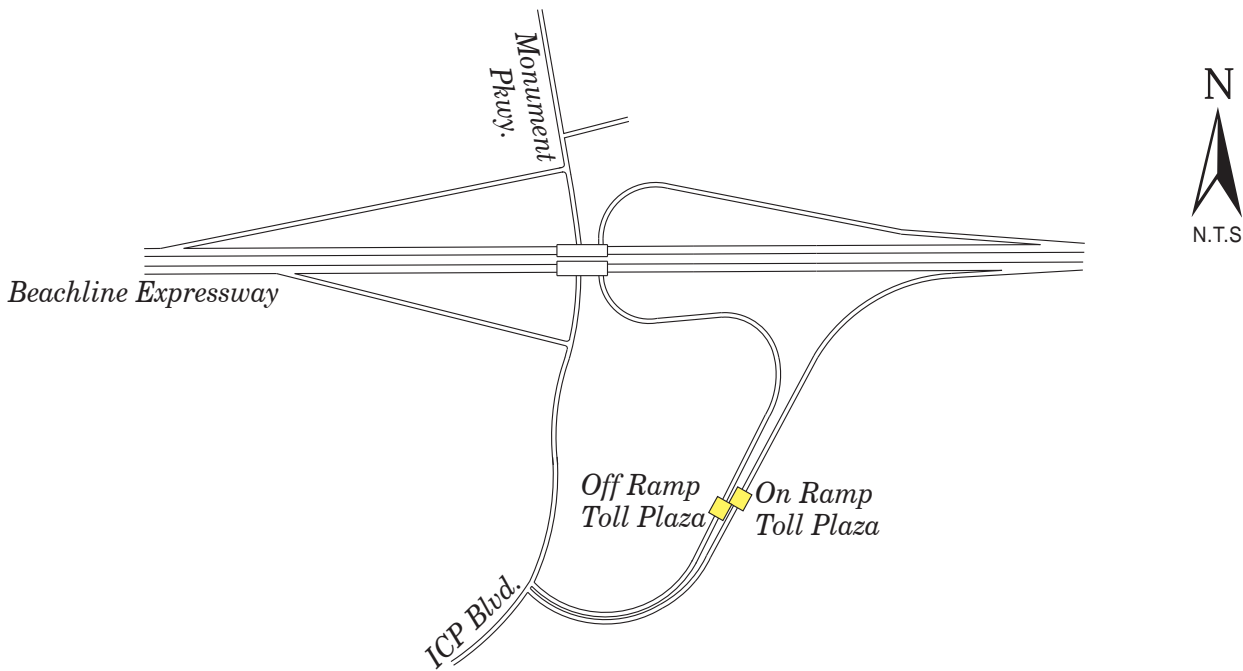

FARE STRUCTURE ALL VEHICLES	
Cash	Electronic
\$ 0.75	\$ 0.59

\* Exact Coin signs are ground mounted; not on canopy

Reports to Beachline Mainline Toll Plaza

Note: All Changeable Message Signs (CMS) can display three messages: EXACT COINS, CHANGE RECEIPTS, E-PASS ONLY

T:\00CEA\NOCEA MANUAL\ST\Toll Facilities Reference Book\2016 Toll Manual - 3/10/16-CP

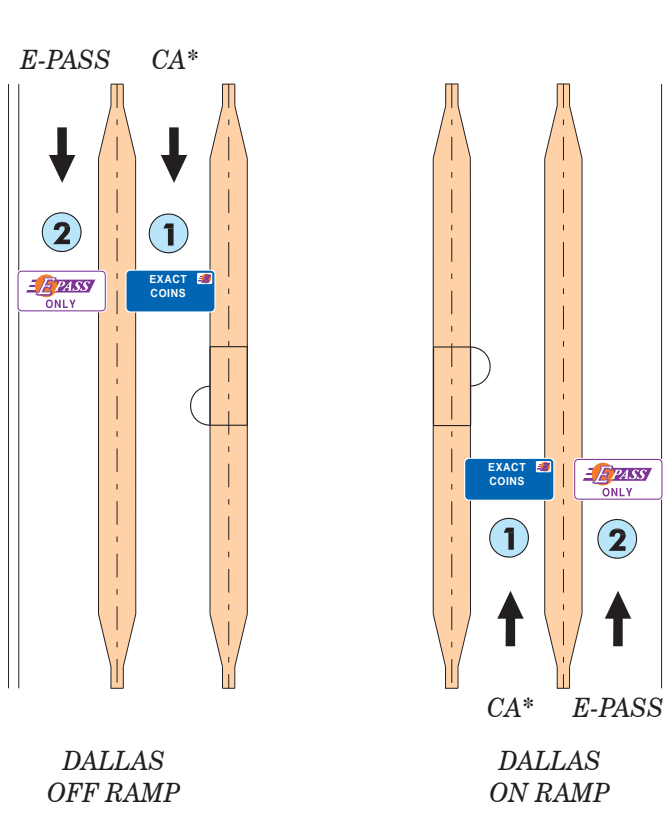
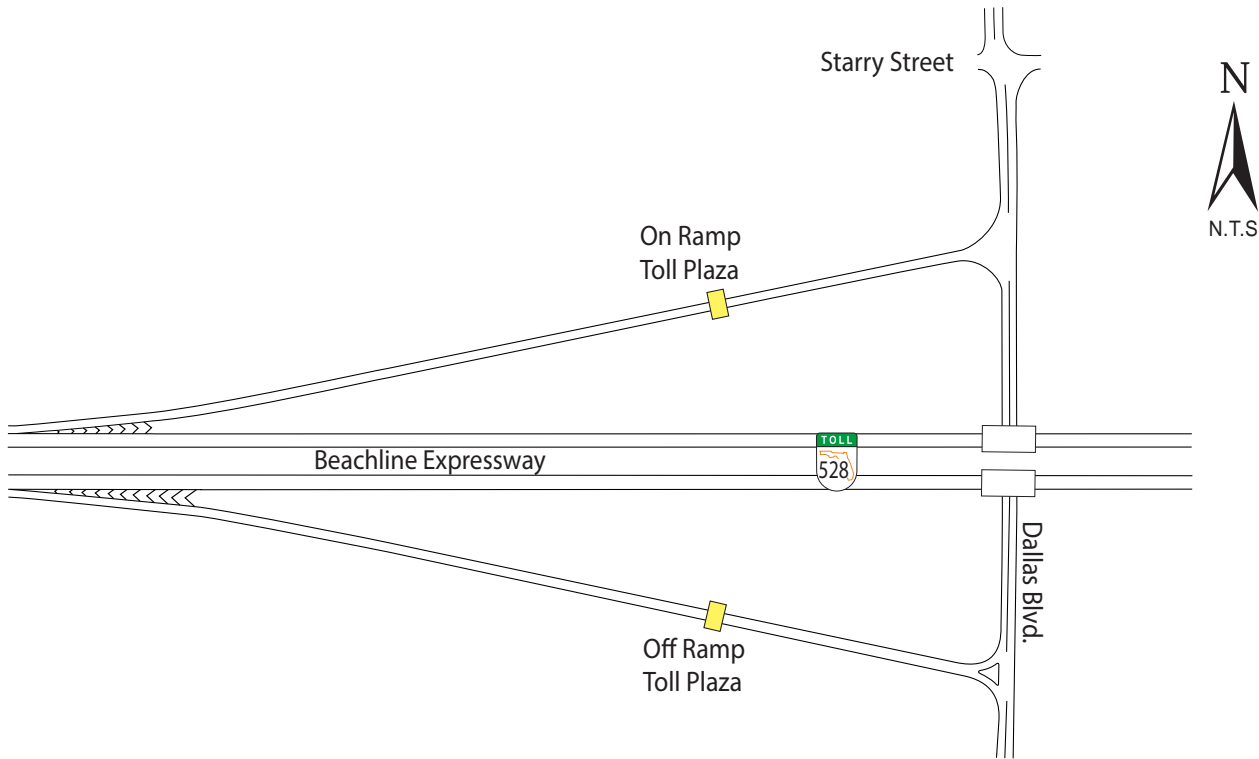

**FARE STRUCTURE  
ALL VEHICLES**

Cash	Electronic
\$ 0.50	\$ 0.50

\* Changeable Message Sign

Note: All Changeable Message Signs (CMS) can display three messages: EXACT COINS, CHANGE RECEIPTS, E-PASS ONLY

Reports to Dallas Blvd. Mainline Toll Plaza

T:\00CEANOCEA MANUAL\ST\Toll Facilities Reference Book\2016 Toll Manual - 3/10/16-CP



To SR 520, I-95 &  
Port Canaveral

Next Interchange: SR 520  
Next Mainline Plaza: None  
Next Ramp Plaza: None  
EB-ON/WB-OFF



Admin.  
Blg.

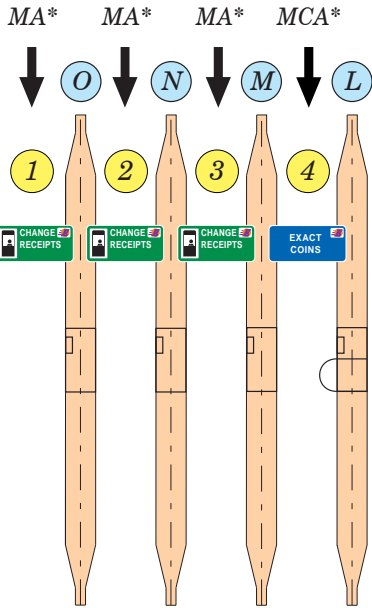

EXPRESS  
E-PASS

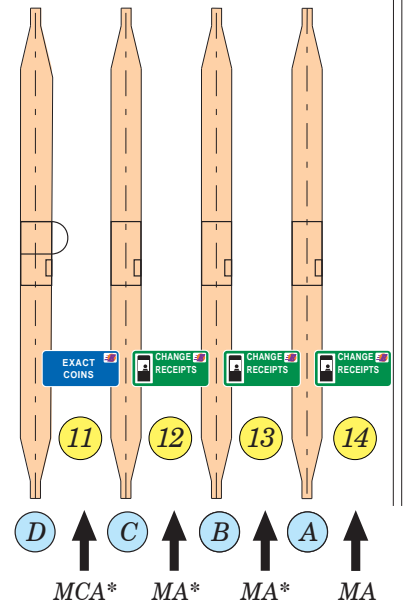
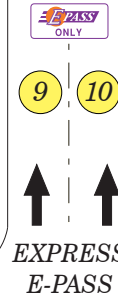
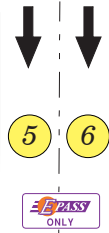

To SR 417 (GreeneWay),  
SR 436 (Semoran Blvd)  
& Orlando Int'l Airport

Next Interchange: Dallas Blvd.  
Next Mainline Plaza: Beachline Mainline  
Next Ramp Plaza: Dallas Blvd.

Note: All Changeable Message Signs (CMS) can display three messages: EXACT COINS, CHANGE RECEIPTS, E-PASS ONLY

**FARE STRUCTURE**

	Cash	Electronic
2 Axles	\$ 1.00	\$ 0.76
3 Axles	\$ 1.25	\$ 1.01
4 Axles	\$ 1.50	\$ 1.26
5 Axles or more	\$ 1.50	\$ 1.26

**LANES OF EQUIPMENT**

- 6 Manned Booths with E-PASS (MA)
- 2 Booths with ACM's and E-PASS
- 4 Express E-PASS (E-PASS only)
- \* Changeable Message Sign



# Goldenrod Road Extension



## Mainline Toll Plaza

**LEGEND**

*For Lane Designations for all Plazas*

*CA - Exact Coin with E-PASS*

*MA - Change Receipts (Manned) with E-PASS*

*MCA - Booth with Manual Lane Terminal,  
Automatic Coin Machine and E-PASS*

**To Orlando International Airport**  
**SR 528 - (Beachline Expressway)**



**Lee Vista Blvd.**  
**To SR 15 (Hoffner Ave.)**  
**Curry Ford Rd. & SR 408**

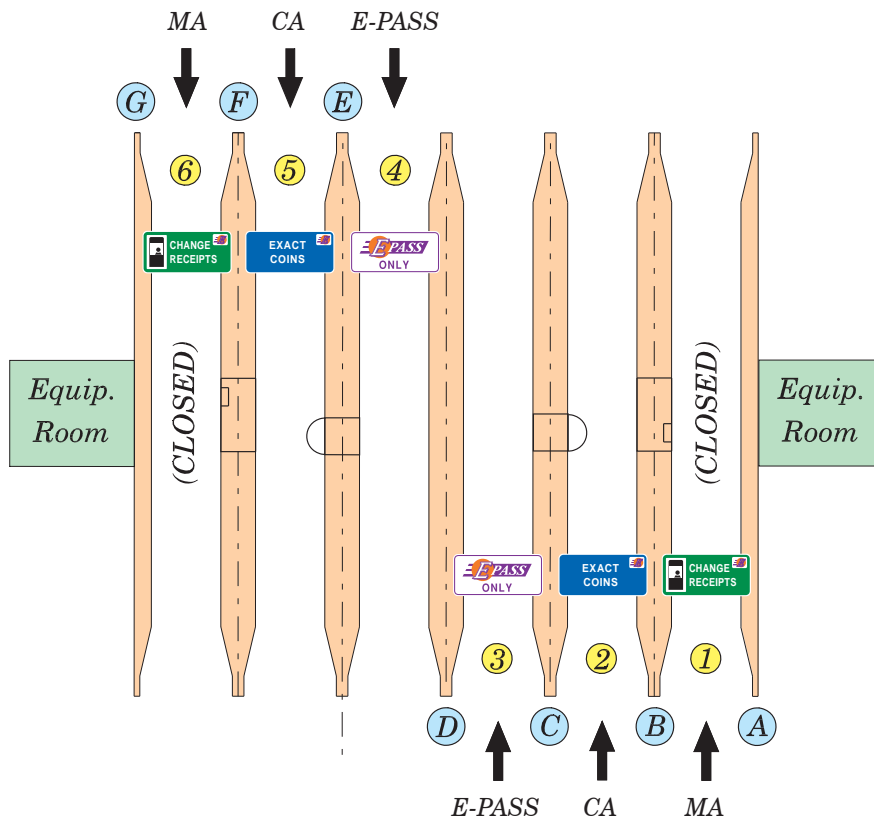

<b>FARE STRUCTURE</b>	
<b>ALL VEHICLES</b>	
<i>Cash</i>	<i>Electronic</i>
\$ 0.50	\$ 0.50

**LANES OF EQUIPMENT**

- 2 Automatic Coin Machines with E-PASS (CA)
- 2 Dedicated E-PASS (E-PASS only)

*Note: All Changeable Message Signs (CMS) can display three messages: EXACT COINS, CHANGE RECEIPTS, E-PASS ONLY*

*Reports to Curry Ford Mainline Toll Plaza*