

# Toll Facilities Reference Manual



**CENTRAL  
FLORIDA  
EXPRESSWAY  
AUTHORITY**

UPDATE January 2022

# TABLE OF CONTENTS

	<u>Page(s)</u>
Overview.....	i
Key Addresses and Telephone Numbers .....	i
E-PASS Service Center .....	i
Mainline Toll Plaza Information.....	ii-iv
Legend .....	v
SR 408 - Mainline Toll Plazas and Associated Ramps .....	1-19
SR 414 - Mainline Toll Plazas and Associated Ramps .....	20-23
SR 417 - Mainline Toll Plazas and Associated Ramps .....	24-40
SR 429 - Mainline Toll Plazas and Associated Ramps .....	41-52
SR 453 - Mainline Toll Plazas .....	53-54
SR 528 - Mainline Toll Plazas and Associated Ramps .....	55-62
SR 538 - Mainline Toll Plazas .....	63-65
SR 551 - Goldenrod - Mainline Toll Plaza .....	66-67
SR 552 - Mainline Toll Plaza and Associated Ramps .....	68-70

# Central Florida Expressway Authority Toll Facilities Reference Manual

## Overview

This Toll Facilities Reference Manual provides pertinent information in a condensed format relevant to the toll plazas on the Central Florida Expressway System.

## Key Addresses & Telephone Numbers

The address and telephone number for the Central Florida Expressway Authority and the E-PASS Service Center are provided below. ***Please note that the information shown for the mainline plazas is for official business only.***

Central Florida Expressway Authority  
4974 ORL Tower Road  
Orlando, FL 32807  
407-690-5000  
[www.cfxway.com](http://www.cfxway.com)

## E-PASS Customer Service Center

E-PASS Service Center  
525 South Magnolia Ave  
Orlando, FL 32801

Hours of Operation: 8:00 a.m. to 6:00 p.m. Monday through Friday  
9:00 a.m. to 1:00 p.m. Saturday

E-PASS Service Center Phone Number: (407) 823-EPASS (823-7277) or 1-800-353-7277

## Mainline Toll Plaza Information



SR 408 (East West Expressway)  
Hiawassee Mainline Toll Plaza  
8302 East West Expressway Hiawassee Main Plaza  
Orlando, FL 32835



SR 408 (East West Expressway)  
Pine Hills Mainline Toll Plaza  
4700 East West Expressway Pine Hills Main Plaza  
Orlando, FL 32808



SR 408 (East West Expressway)  
Conway West Mainline Toll Plaza  
4901 SR 408 (East West Expressway) Main Plaza  
Orlando, FL 32807



SR 408 (East West Expressway)  
Conway East Mainline Toll Plaza  
5320 SR 408 (East West Expressway) Main Plaza  
Orlando, FL 32807



SR 408 (East West Expressway)  
Dean Mainline Toll Plaza  
10500 East West Expressway Dean Main Plaza  
Orlando, FL 32825



SR 414 (Apopka Expressway)  
Coral Hills Mainline Toll Plaza  
2401 State Road 414  
Apopka, FL 32703



SR 417 (Central Florida GreeneWay)  
John Young Parkway Mainline Toll Plaza  
14200 GreeneWay  
Orlando, FL 32837



SR 417 (Central Florida GreeneWay)  
Boggy Creek Mainline Toll Plaza  
13700 GreeneWay  
Orlando, FL 32824

## Mainline Toll Plaza Information



SR 417 (Central Florida GreeneWay)  
Curry Ford Mainline Toll Plaza  
5300 GreeneWay  
Orlando, FL 32829



SR 417 (Central Florida GreeneWay)  
University Mainline Toll Plaza  
2600 GreeneWay  
Orlando, FL 32817



SR 429 (Western Beltway)  
Forest Lake Mainline Toll Plaza  
3170 N. SR 429  
Ocoee, FL 34761



SR 429 (Western Beltway)  
Independence Mainline Toll Plaza  
4002 SR 429  
Winter Garden, FL 34787



SR 429 (Western Beltway)  
Ponkan Mainline Toll Plaza  
3150 W Ponkan Rd  
Apopka, FL 32712



SR 429 (Western Beltway)  
Mt. Plymouth Mainline Toll Plaza  
6580 Mount Plymouth Road  
Apopka, FL 32712



SR 453 (Wekiva Parkway)  
Coronado Mainline Toll Plaza  
22500 Coronado Somerset Dr.  
Sorrento, FL 32776

## Mainline Toll Plaza Information



SR 528 (Beachline Expressway)  
Dallas Mainline Toll Plaza  
12799 SR 528  
Orlando, FL 32833



SR 528 (Beachline Expressway)  
Beachline Mainline Toll Plaza  
12500 Beachline Expressway  
Orlando, FL 32832



SR 538 (Poinciana Parkway)  
Marigold Mainline Toll Plaza  
MM: 3.0



SR 538 (Poinciana Parkway)  
KOA Mainline Toll Plaza  
MM: 5.5



SR 552 (Osceola Parkway)  
Shingle Creek Mainline Toll Plaza  
3451 W Osceola Pkwy  
Kissimmee, FL 34741

# LEGEND



Infinity Lane  
Number

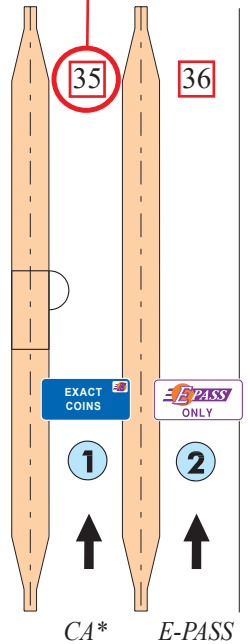

OFF RAMP  
R02  
PID: \*\*\*

Ramp Number and  
Infinity Plaza ID

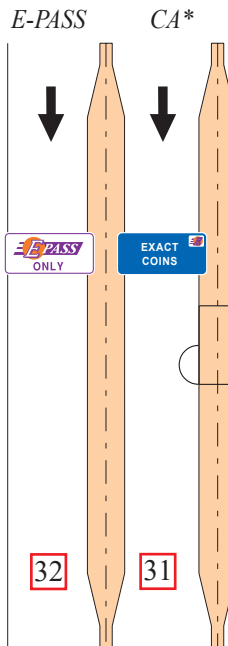

ON RAMP  
R01  
PID: \*\*\*

Reports to Mainline Toll Plaza



CFX Organizational ID  
and Mainline Facility

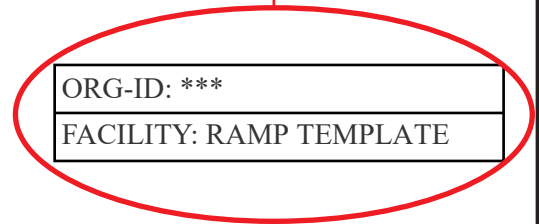

\* Changeable Message Sign

Note: All Changeable Message Signs (CMS) can display three messages: EXACT COINS, CHANGE RECEIPTS, E-PASS ONLY

# East-West Expressway



## Mainline Toll Plazas and Associated Ramps

LEGEND

*For Lane Designations for all Plazas*

*CA - Exact Coin with E-PASS*

*MA - Change Receipts (Staffed) with E-PASS*

*MCA - Booth with Manual Lane Terminal,  
Automatic Coin Machine and E-PASS*





To Florida's Turnpike & SR 50

Next Interchange: Good Homes Road



Admin. Bldg.

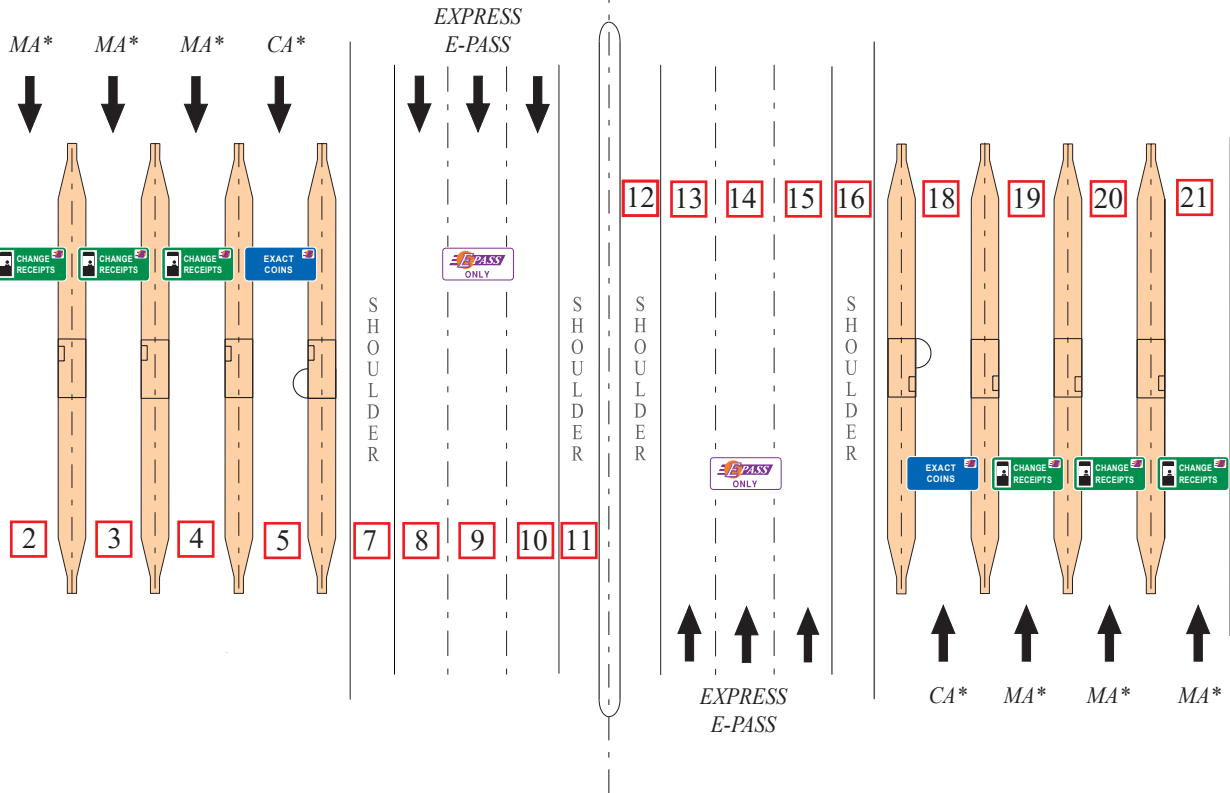

To I-4 (Downtown Orlando)

Next Interchange: Hiwassee Rd.

Next Mainline Plaza: Pine Hills Mainline

Next Ramp Plaza: Hiwassee Rd. EB-ON/

WB-OFF



Note: All Changeable Message Signs (CMS) can display three messages: EXACT COINS, CHANGE RECEIPTS, E-PASS ONLY

ORG-ID: 5	PID: 320
FACILITY: SR 408 - HIWASSEE	

LANES OF EQUIPMENT

- 6 Staffed Booth with E-PASS (MA)
- 2 Booths with Automatic Coin Machines with E-PASS (CA)
- 6 Express E-PASS (E-PASS only)
- \* Changeable Message Sign

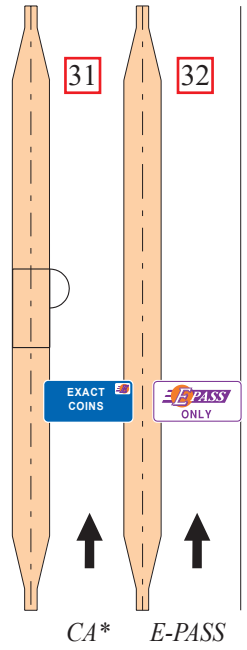
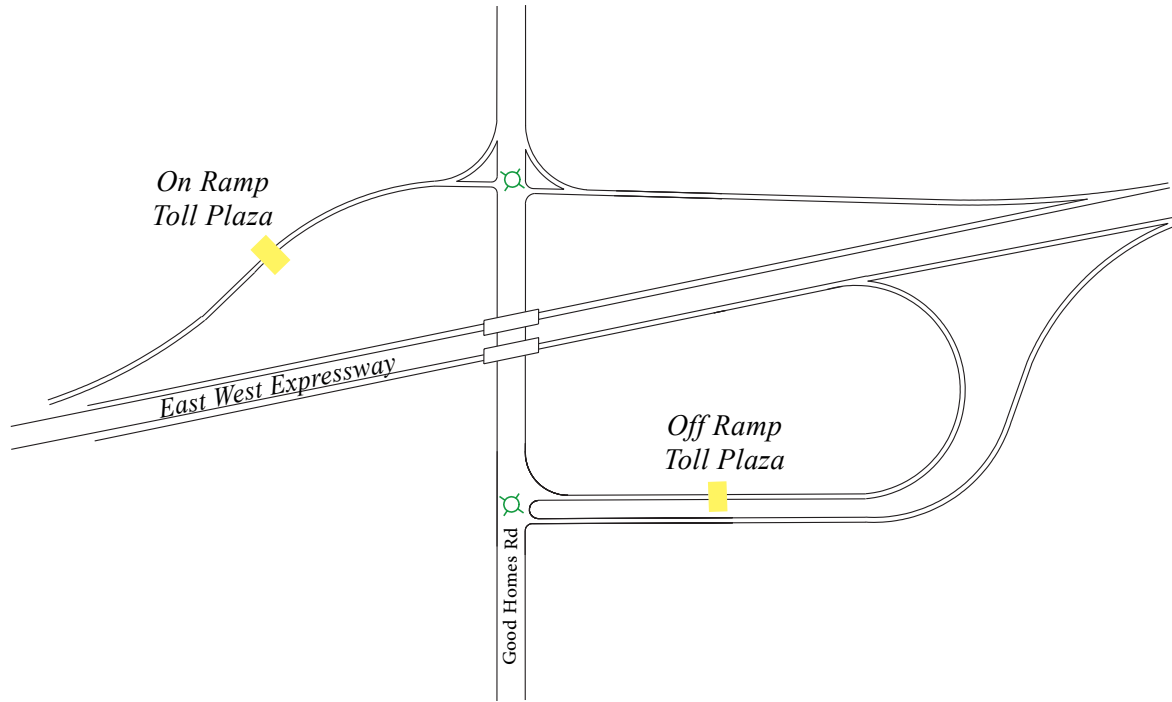

GOOD HOMES  
ON RAMP  
R01  
PID: 390

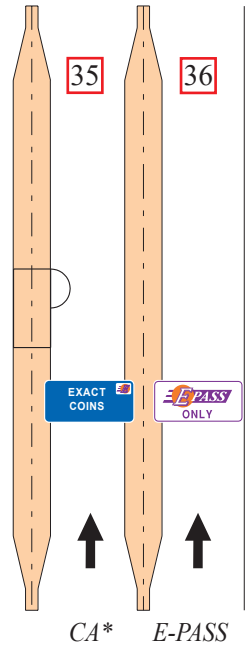

GOOD HOMES  
OFF RAMP  
R02  
PID: 391

ORG-ID: 5  
FACILITY: SR 408 - HIAWASSEE

\* Changeable Message Sign

Note: All Changeable Message Signs (CMS) can display three messages: EXACT COINS, CHANGE RECEIPTS, E-PASS ONLY

Reports to Hiawassee Mainline Toll Plaza

T:\OCEA\OCEA MANUAL\STol Facilities Reference Book\2016 Tolls Manual - 3/10/16-CP

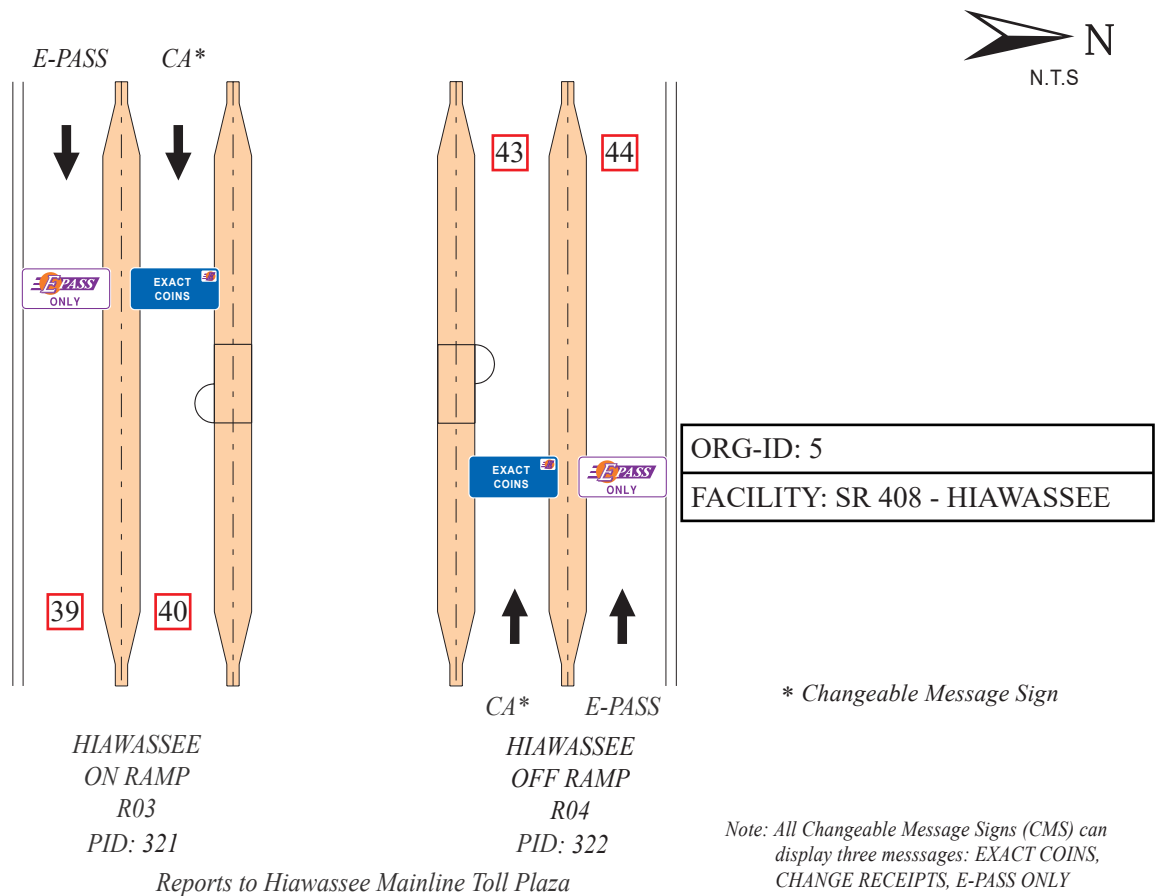
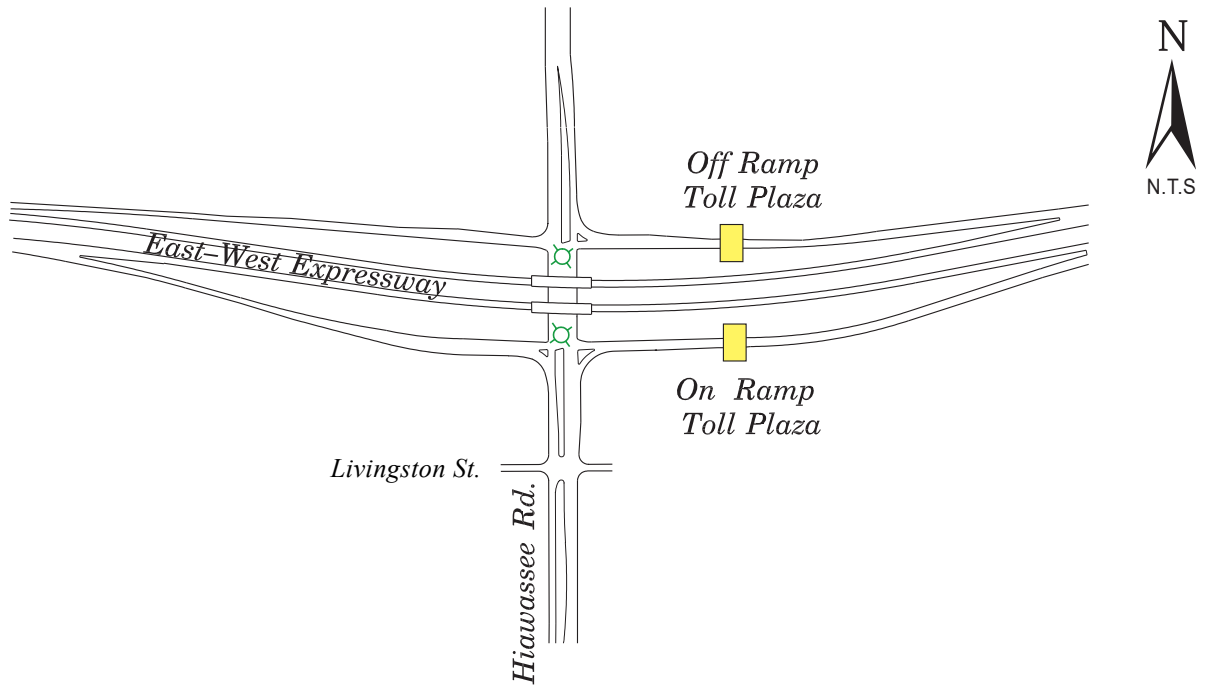

T:\OCEA\OCEA MANUAL\STol Facilities Reference Book\2016 Tolls Manual - 3/10/16-CP



To Florida's Turnpike

Next Interchange: Pine Hills Rd.  
 Next Mainline Plaza: Hiwassee Mainline  
 Next Ramp Plaza: Hiwassee Rd. EB-ON/  
 WB-OFF

To I-4 (Downtown Orlando)

Next Interchange: John Young Pkwy. (CR 423)  
 Next Mainline Plaza: Conway East & West Mainline  
 Next Ramp Plaza: John Young Pkwy. EB-ON/  
 WB-OFF

Admin. Bldg.

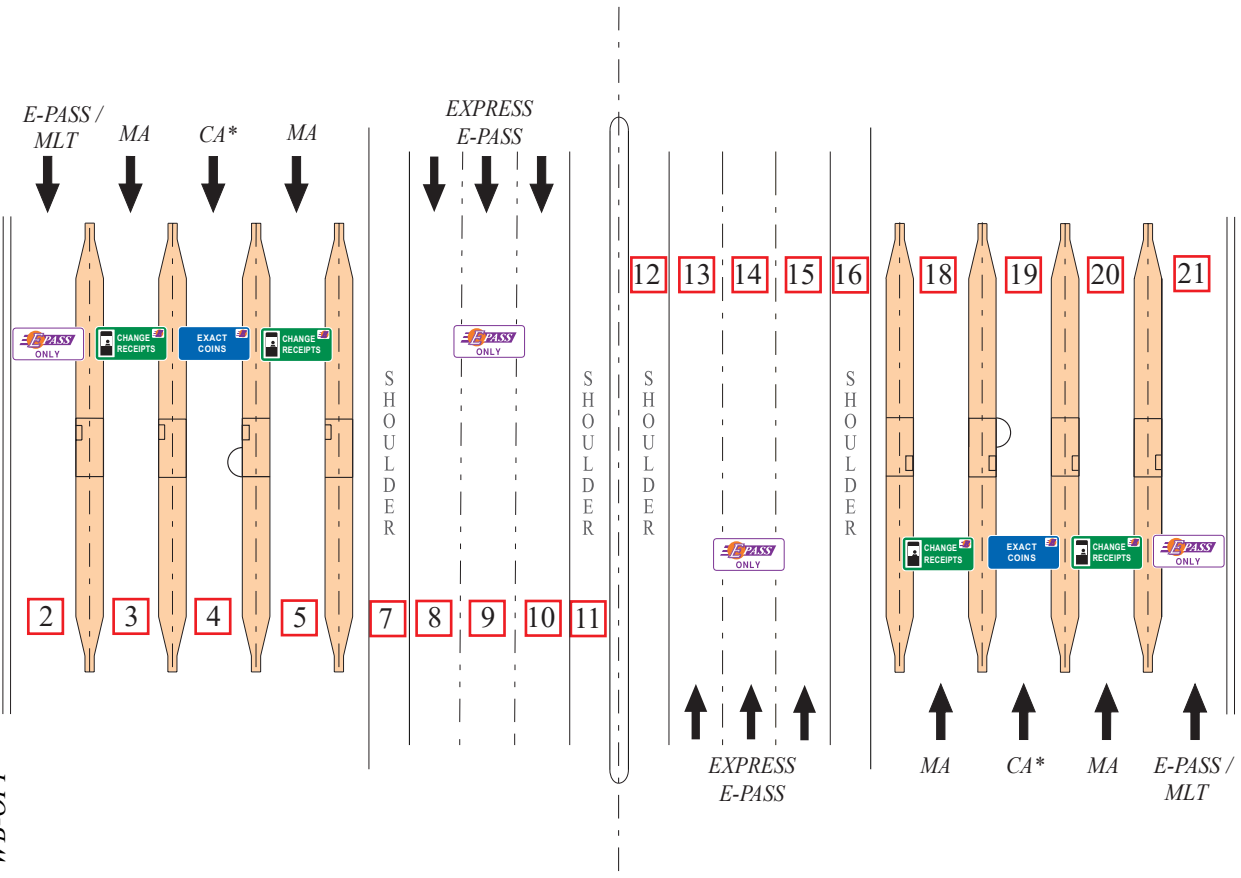

Note: All Changeable Message Signs (CMS) can display three messages: EXACT COINS, CHANGE RECEIPTS, E-PASS ONLY

ORG-ID: 12      PID: 382  
 FACILITY: SR 408 - PINE HILLS

LANES OF EQUIPMENT

- 4 Staffed Booths with E-PASS (MA)
- 2 Booths with Automatic Coin Machines with E-PASS (CA)
- 2 Booths with E-PASS and MLT
- 6 Express E-PASS only

\* Changeable Message Sign

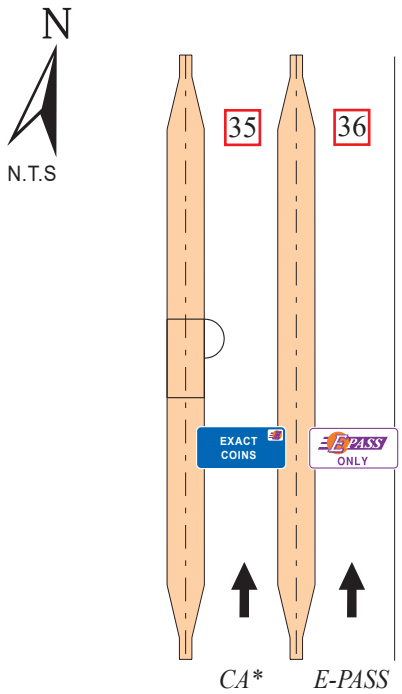
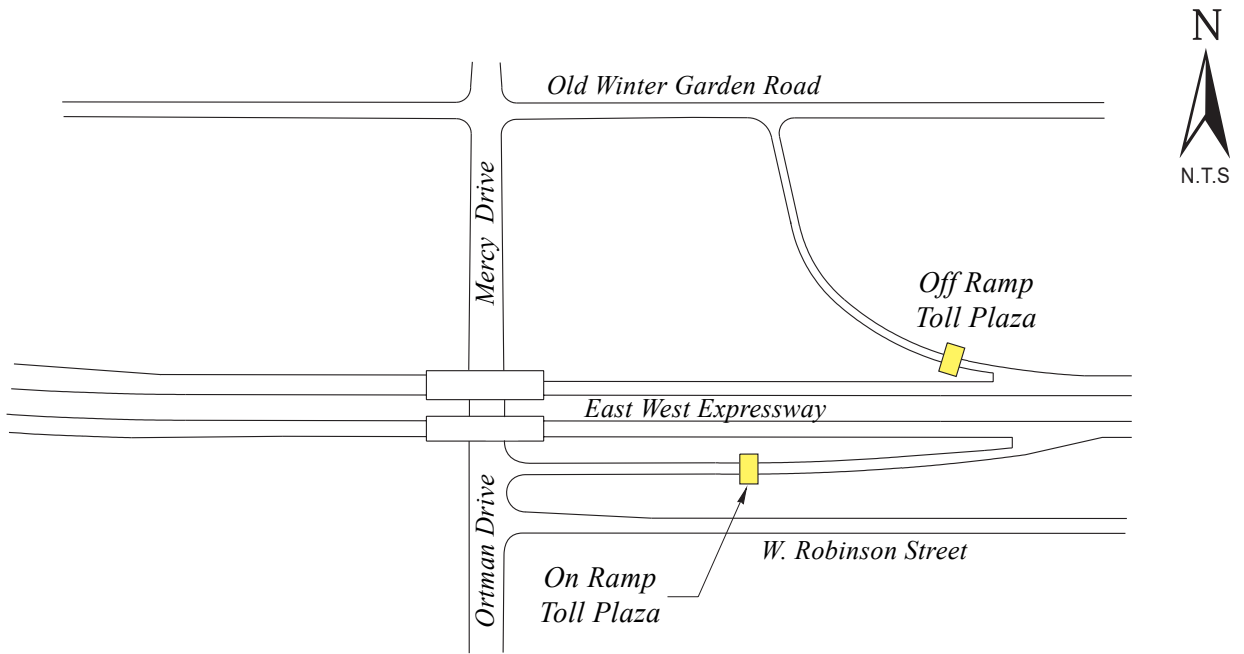

OLD WINTER GARDEN  
OFF RAMP  
R02  
PID: 384

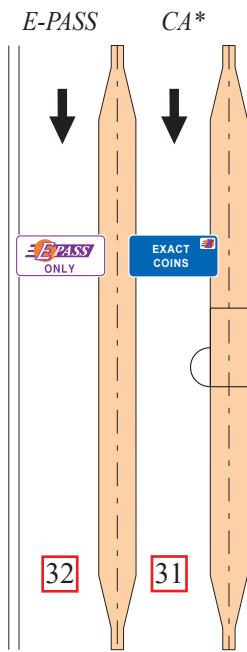

OLD WINTER GARDEN  
ON RAMP  
R01  
PID: 383

ORG-ID: 12  
FACILITY: SR 408 - PINE HILLS

\* Changeable Message Sign

Note: All Changeable Message Signs (CMS) can display three messages: EXACT COINS, CHANGE RECEIPTS, E-PASS ONLY

Reports to Pine Hills Mainline Toll Plaza

T:\OCEA\OCEA MANUALS\Toll Facilities Reference Book\2016 Toll Manual - 3/10/16-CP

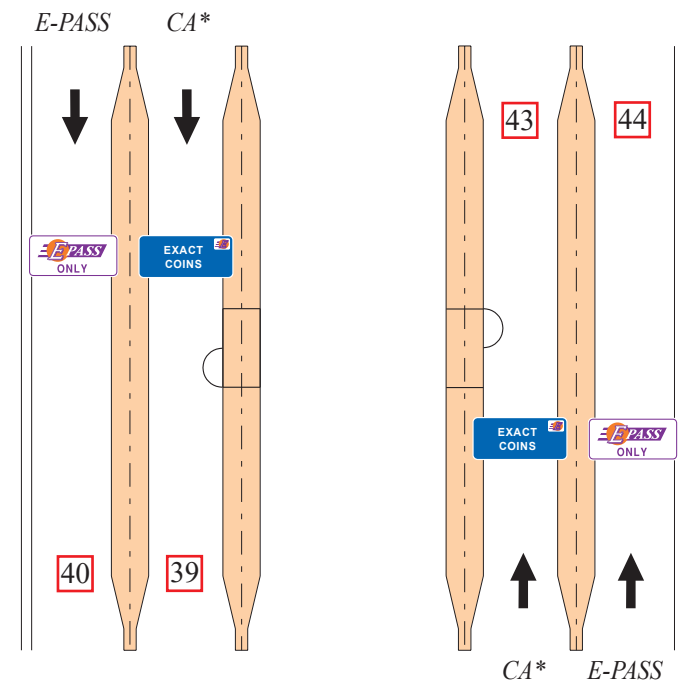
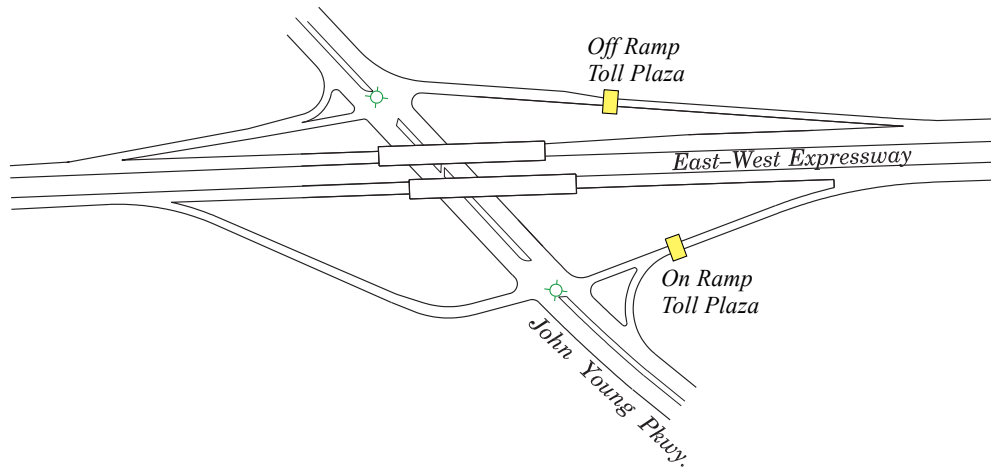

JOHN YOUNG PARKWAY  
ON RAMP  
R03  
PID: 385

JOHN YOUNG PARKWAY  
OFF RAMP  
R04  
PID: 386

ORG-ID: 12  
FACILITY: SR 408 - PINE HILLS

\* Changeable Message Sign

Note: All Changeable Message Signs (CMS) can display three messages: EXACT COINS, CHANGE RECEIPTS, E-PASS ONLY

Reports to Pine Hills Mainline Toll Plaza

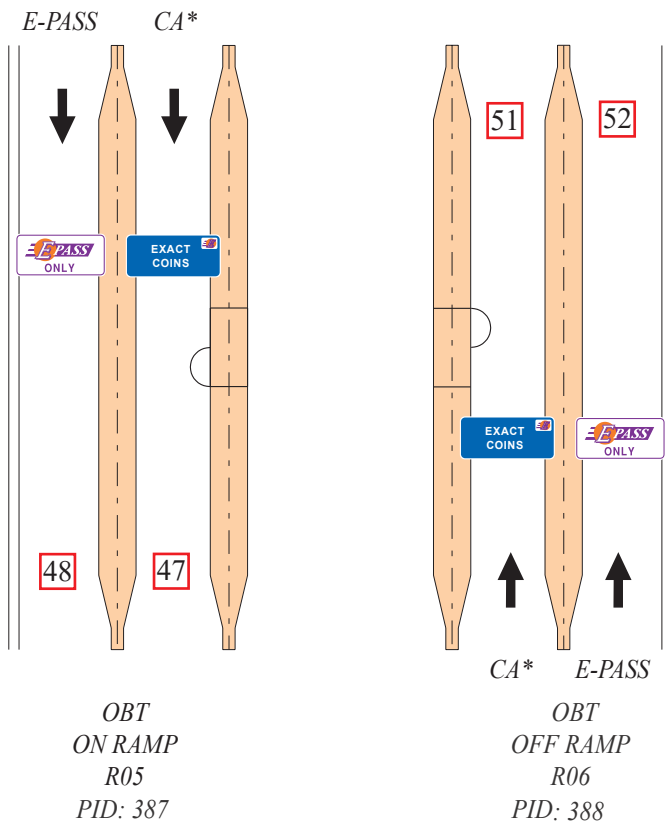
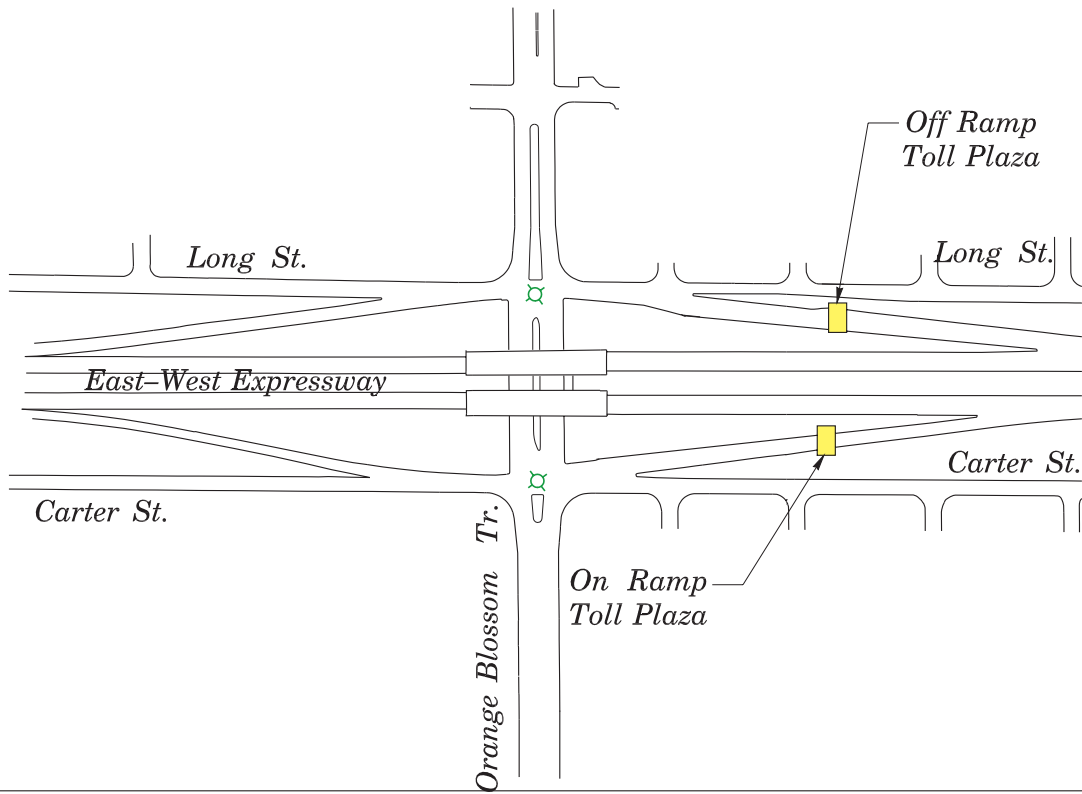

ORG-ID: 12  
 FACILITY: SR 408 - PINE HILLS

\* Changeable Message Sign

Note: All Changeable Message Signs (CMS) can display three messages: EXACT COINS, CHANGE RECEIPTS, E-PASS ONLY

Reports to Pines Hills Mainline Toll Plaza

T:\OCEA\OCEA MANUAL\STol Facilities Reference Book\2016 Tolls Manual - 3/10/16-CP

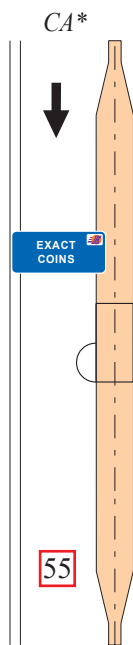
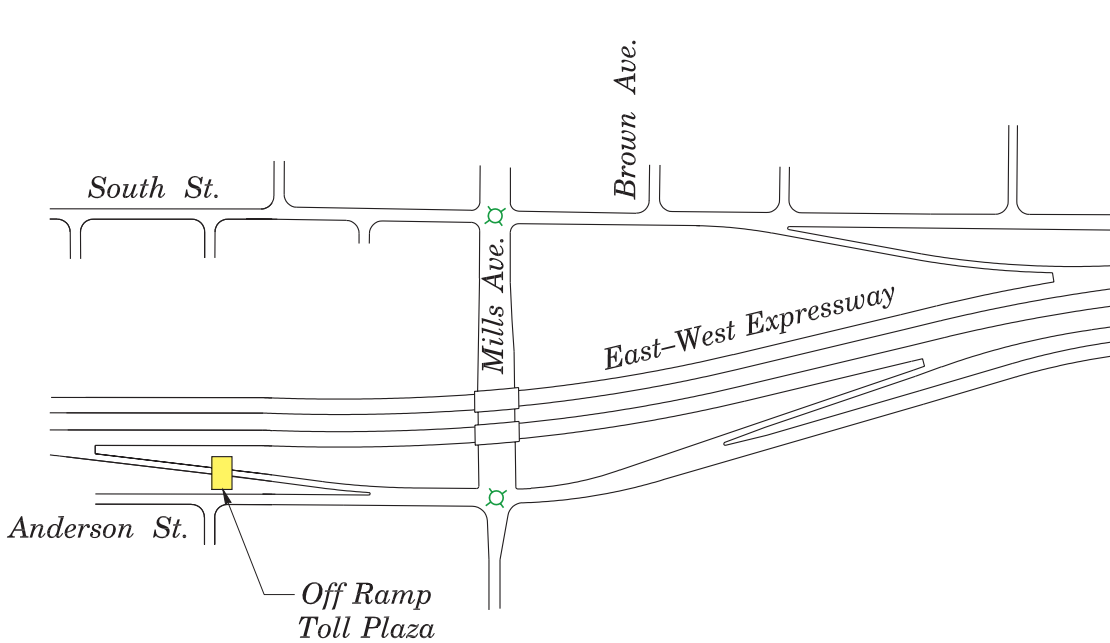

ORG-ID: 12
FACILITY: SR 408 - PINE HILLS

MILLS  
OFF RAMP  
R07  
PID: 389

*Note: All Changeable Message Signs (CMS) can display three messages: EXACT COINS, CHANGE RECEIPTS, E-PASS ONLY*

*Reports to Pine Hills Mainline Toll Plaza*

T:\OCEA\OCEA MANUAL\STol Facilities Reference Book\2016 Tolls Manual - 3/10/16-CP





To I-4 (Downtown Orlando)

Next Interchange: Crystal Lake Dr.  
Next Mainline Plaza: Pine Hills Mainline  
Next Ramp Plaza: Orange Blossom Trail  
WB-OFF / EB-ON

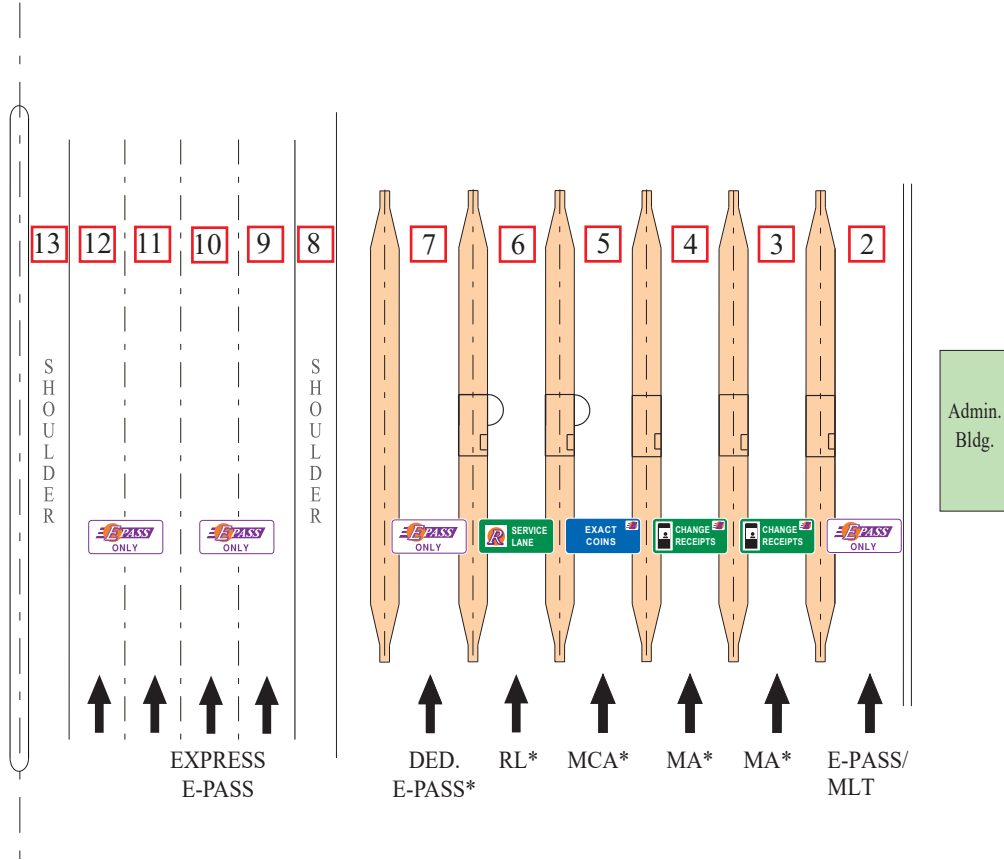

ORG-ID: 13	PID: 392
FACILITY: SR 408 - CONWAY WESTBOUND	

LANES OF EQUIPMENT

- 2 Staffed Booths with E-PASS (MA)
- 1 Booth with MCA
- 1 Booths with E-PASS and MLT
- 1 E-PASS Reload Lane (RL)
- 1 Dedicated E-PASS
- 4 Express E-PASS (E-PASS only)
- \* Changeable Message Sign

\*\* Peak Hour Operates as a Manual Booth

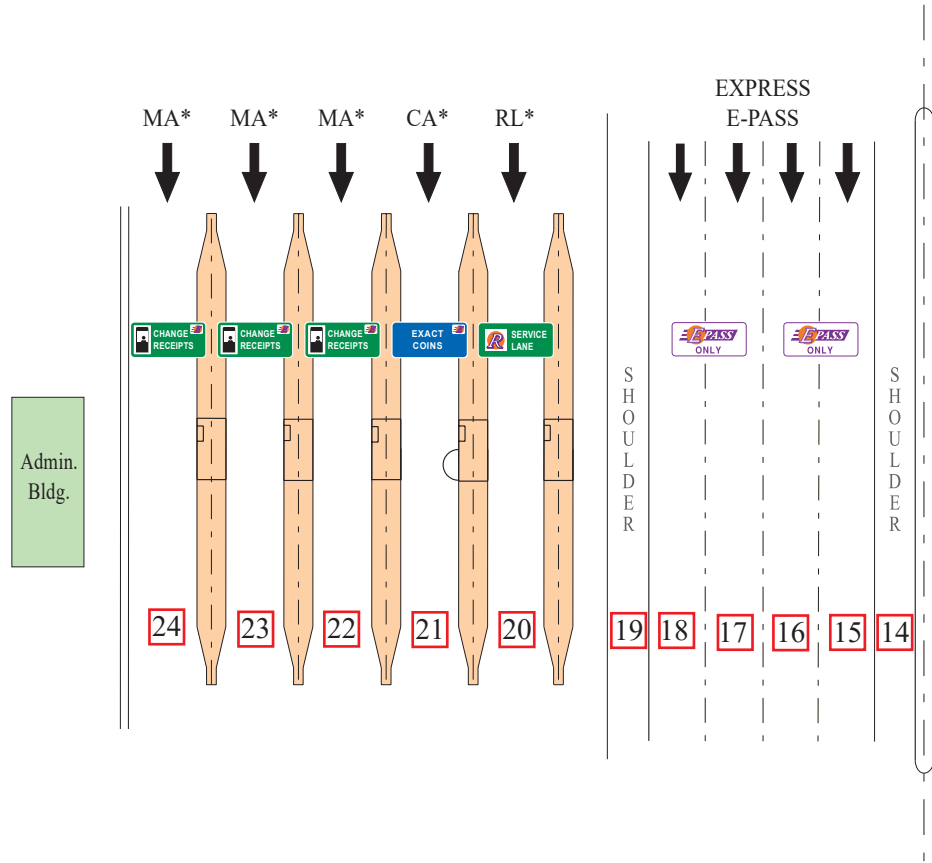

T:\OCEA\OCEA MANUAL\STol Facilities Reference Book\2016 Tolls Manual - 4/1/16-CP

↓ To SR 417 (Greene Way),

UCF & SR 50

Next Interchange: SR 551 (Goldenrod Rd.)

Next Mainline Plaza: Dean Mainline

Next Ramp Plaza: Dean Rd.

EB-OFF / WB-ON

ORG-ID: 13 PID: 392

FACILITY: SR 408 - CONWAY EASTBOUND

LANES OF EQUIPMENT

- 3 Staffed Booths with E-PASS (MA)
- 1 Booths with Automatic Coin Machines (ACM) with E-PASS
- 1 E-PASS Reload Lane (RL)
- 4 Express E-PASS (E-PASS only)
- \* Changeable Message Sign

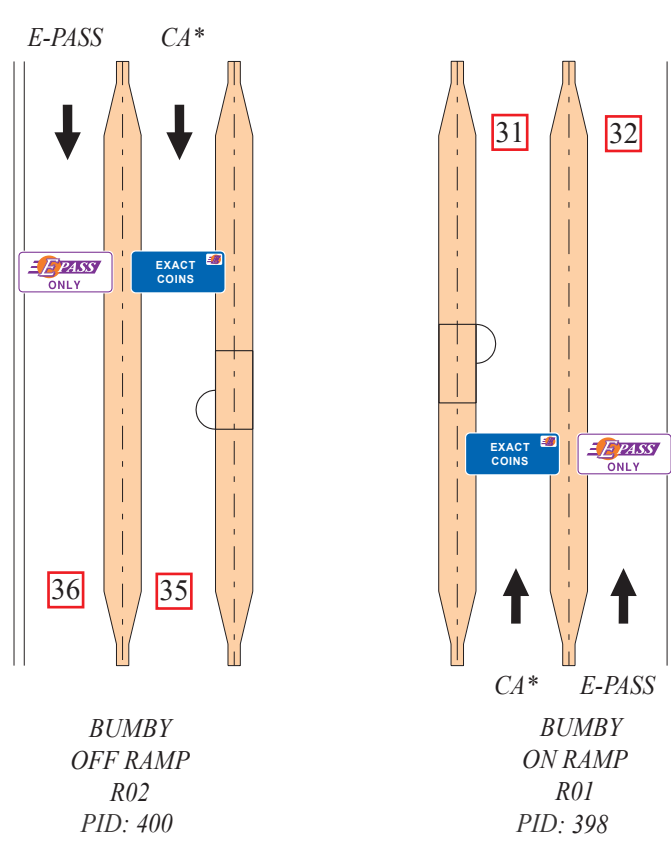
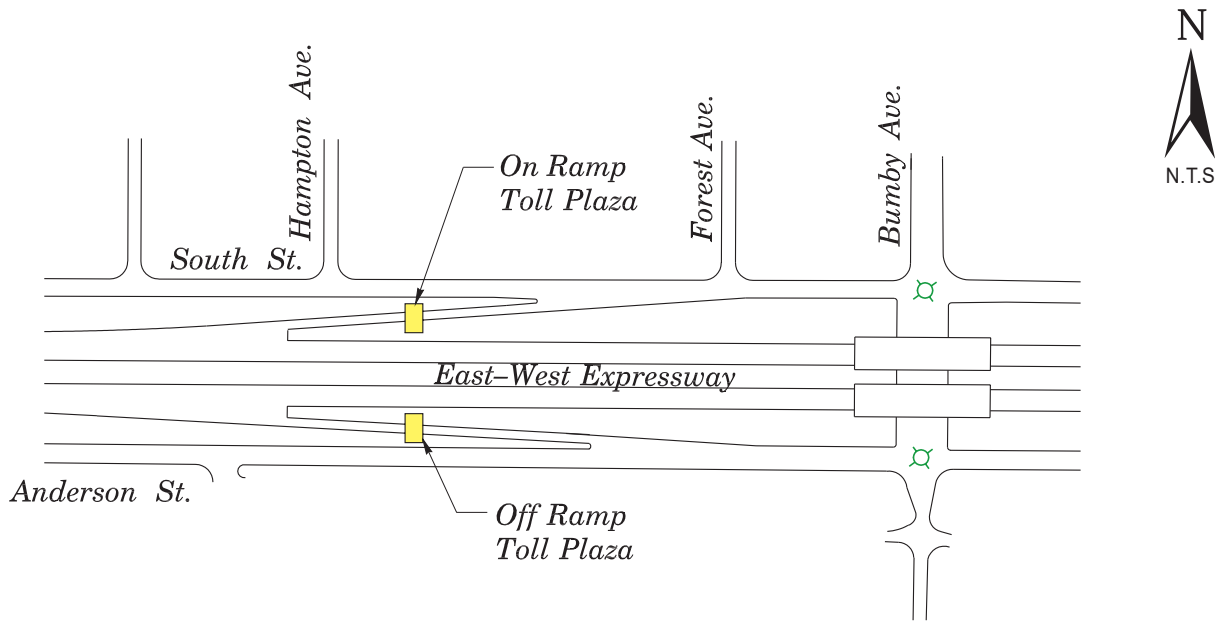

ORG-ID: 13  
 FACILITY: SR 408 - CONWAY

\* Changeable Message Sign

Note: All Changeable Message Signs (CMS) can display three messages: EXACT COINS, CHANGE RECEIPTS, E-PASS ONLY

Reports to Conway Mainline Toll Plaza

T:\OCEA\OCEA MANUAL\STol Facilities Reference Book\2016 Tolls Manual - 3/10/16-CP

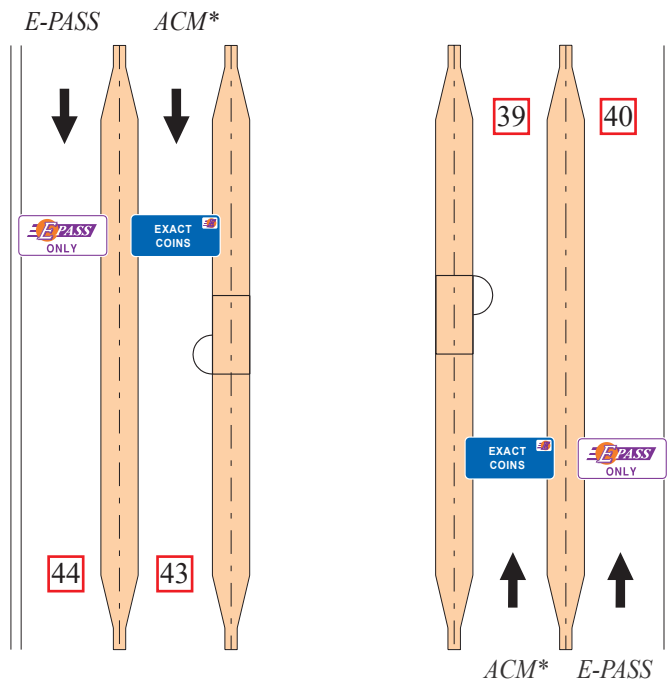
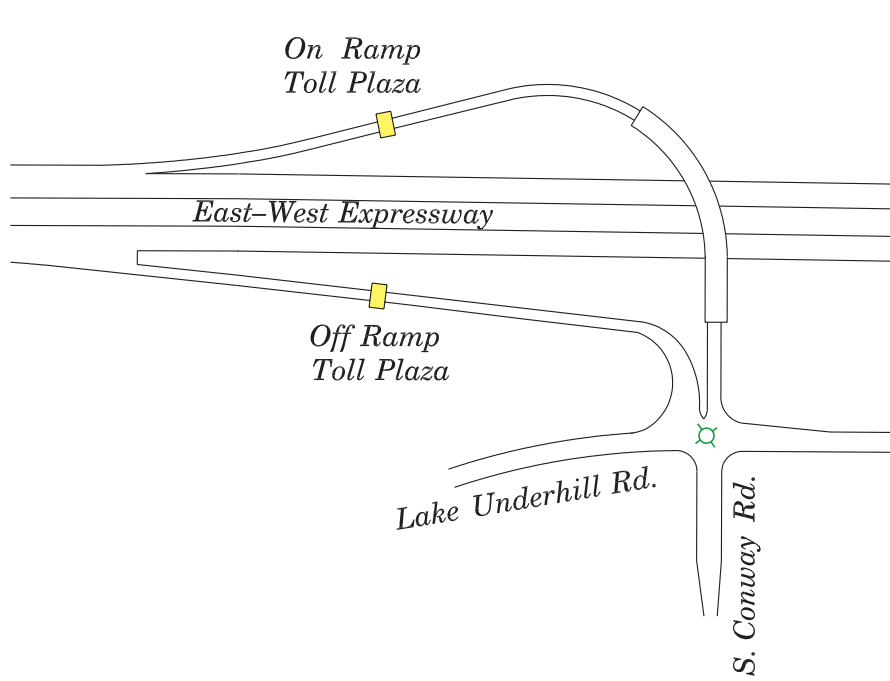

ORG-ID: 13  
 FACILITY: SR 408 - CONWAY

CONWAY  
 OFF RAMP  
 R04  
 PID: 394

CONWAY  
 ON RAMP  
 R03  
 PID: 393

\* Changeable Message Sign

Note: All Changeable Message Signs (CMS) can display three messages: EXACT COINS, CHANGE RECEIPTS, E-PASS ONLY

Reports to Conway Mainline Toll Plaza

T:\OCEA\OCEA MANUAL\STol Facilities Reference Book\2016 Tolls Manual - 3/10/16-CP

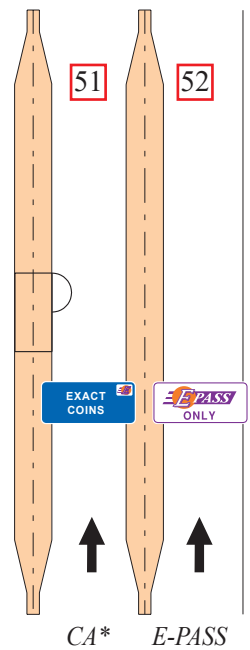
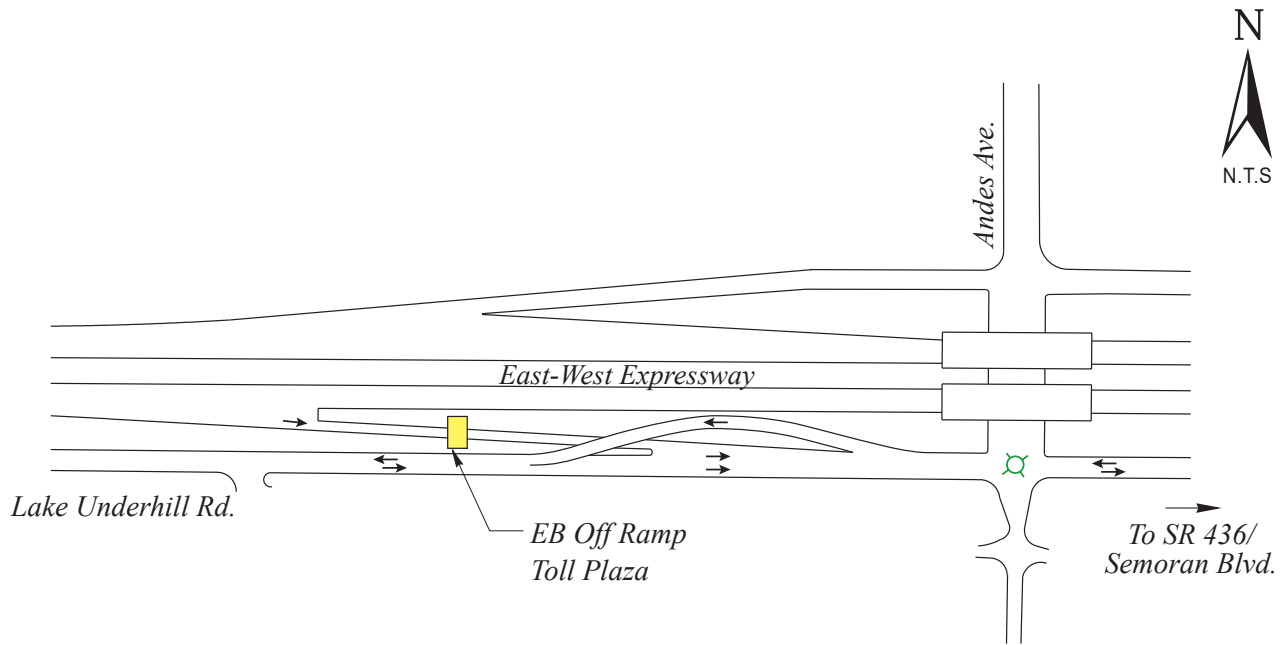

ANDES AVE. / LAKE UNDERHILL RD.  
 SR 436 / SEMORAN BLVD.  
 EASTBOUND OFF RAMP  
 R06  
 PID: 396

Reports to Conway Mainline Toll Plaza

ORG-ID: 13  
 FACILITY: SR 408 - CONWAY

\* Changeable Message Sign

Note: All Changeable Message Signs (CMS) can display three messages: EXACT COINS, CHANGE RECEIPTS, E-PASS ONLY

T:\OCEA\OCEA MANUAL\STol Facilities Reference Book\2016 Tolls Manual - 3/10/16-CP

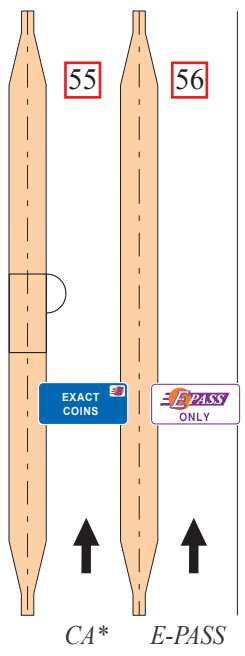
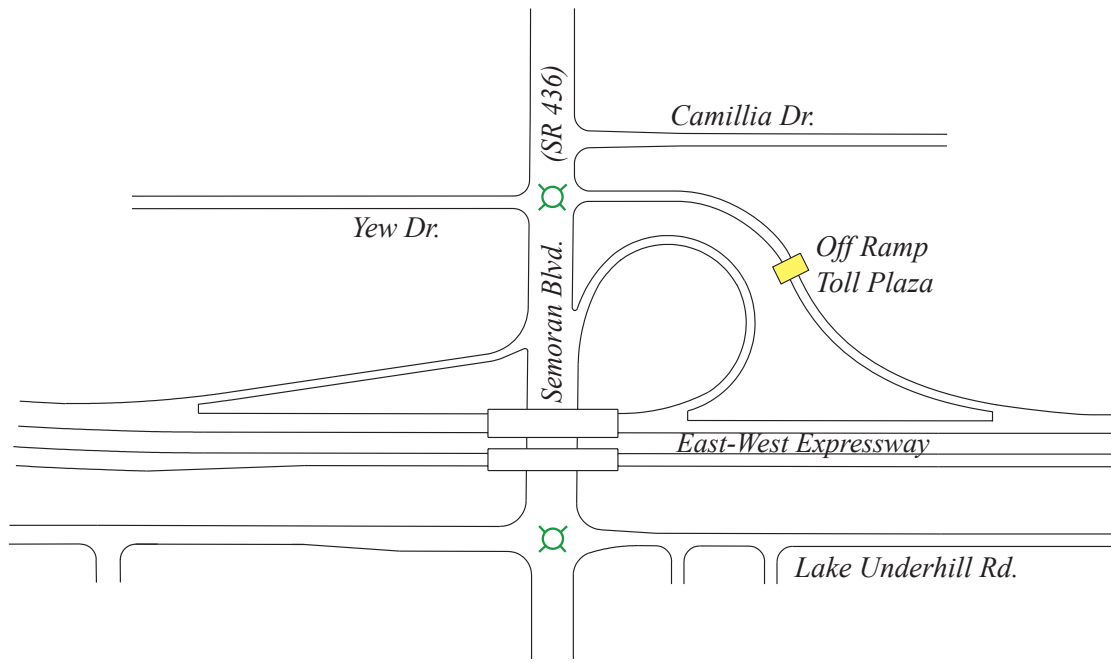

ORG-ID: 13  
 FACILITY: SR 408 - CONWAY

SR 436 / SEMORAN  
 WESTBOUND OFF RAMP  
 R07  
 PID: 395

\* All Changeable Message Signs (CMS) can display three messages: EXACT COINS, CHANGE RECEIPTS, E-PASS ONLY

Reports to Conway Mainline Toll Plaza

T:\OCEA\OCEA MANUAL\STol Facilities Reference Book\2016 Tolls Manual - 3/10/16-CP

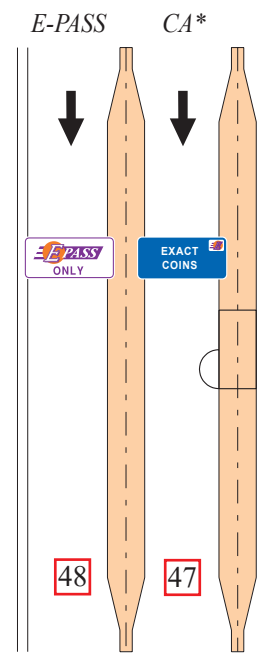
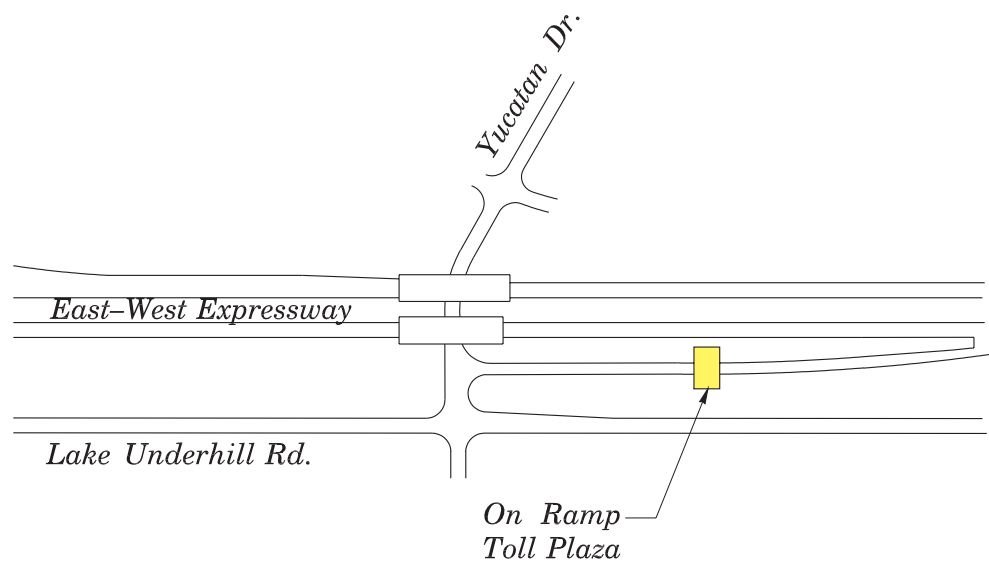

ORG-ID: 13  
 FACILITY: SR 408 - CONWAY

SEMORAN/YUCATAN DR. EASTBOUND  
 ON RAMP  
 R05  
 PID: 397

\* All Changeable Message Signs (CMS) can display three messages: EXACT COINS, CHANGE RECEIPTS, E-PASS ONLY

Reports to Conway Mainline Toll Plaza

T:\OCEA\OCEA MANUAL\STol Facilities Reference Book\2016 Tolls Manual - 3/10/16-CP



↑  
**To SR 417 (GreeneWay) & Downtown Orlando**  
 Next Interchange: Dean Rd.  
 Next Mainline Plaza: Conway East & West Mainline  
 Next Ramp Plaza: Dean EB-ON/WB-OFF

↓  
**To SR 50, UCF & Titusville**  
 Next Interchange: Rouse Rd.  
 Next Mainline Plaza: None  
 Next Ramp Plaza: Rouse EB-ON/WB-OFF

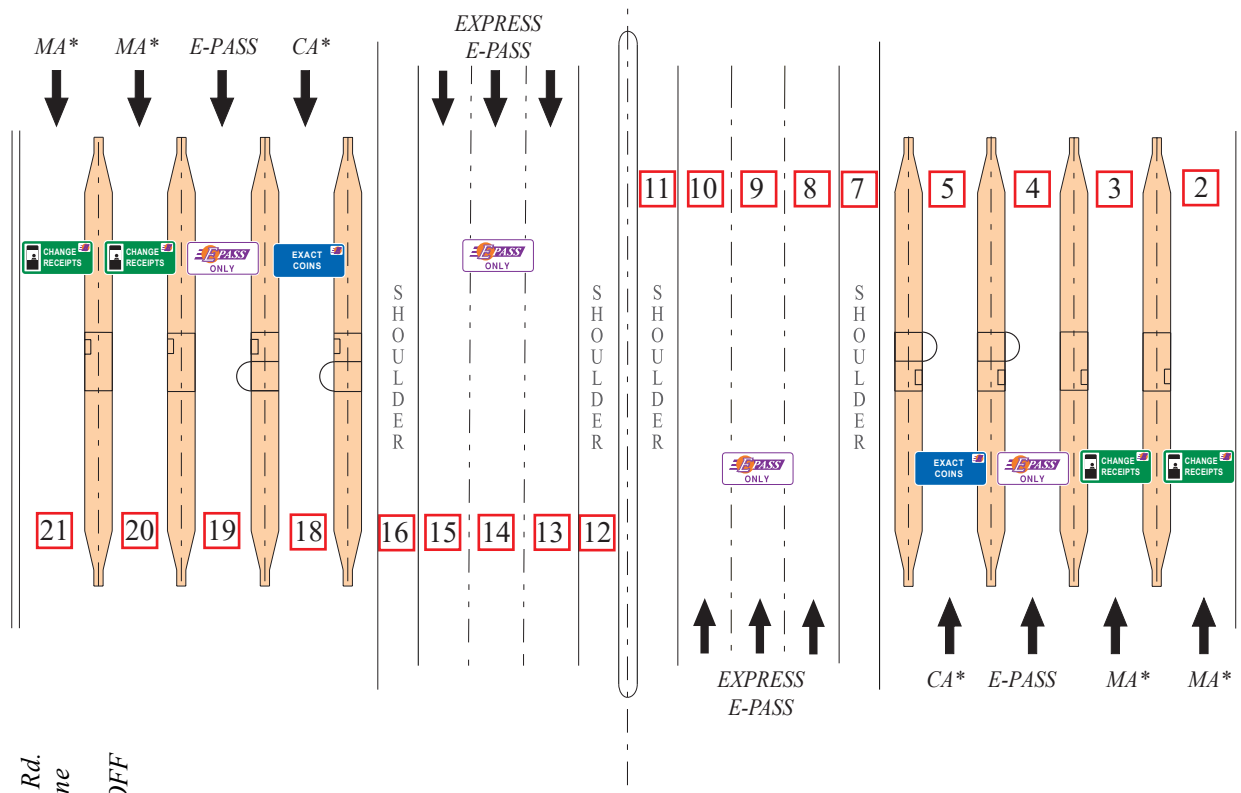

Note: All Changeable Message Signs (CMS) can display three messages: EXACT COINS, CHANGE RECEIPTS, E-PASS ONLY

ORG-ID: 4	PID: 315
FACILITY: SR 408 - DEAN	

- LANES OF EQUIPMENT
- 6 Express E-PASS (E-PASS only)
  - 2 Booths with Automatic Coin Machines with E-PASS (ACM)
  - 4 Staffed Booths with E-PASS (MA)
  - \* Changeable Message Sign



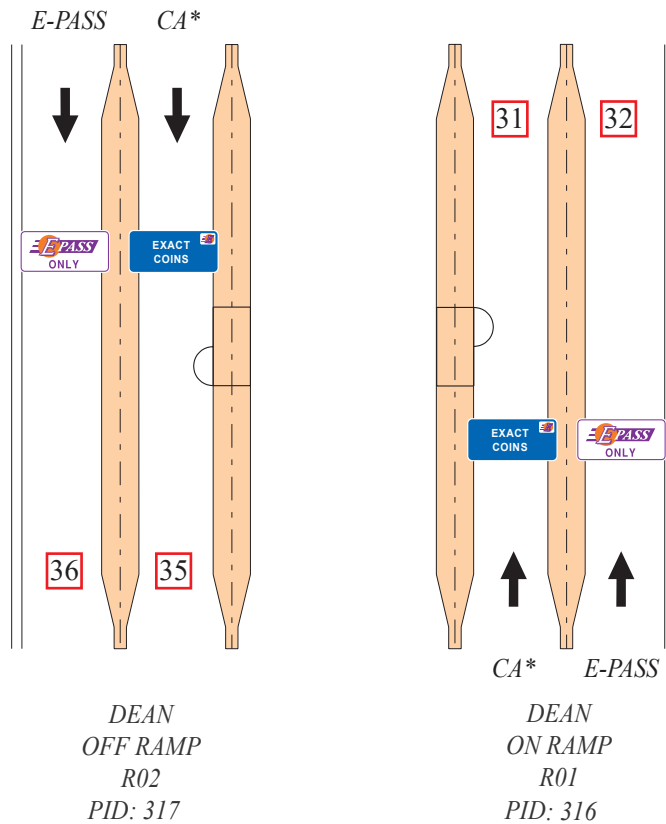
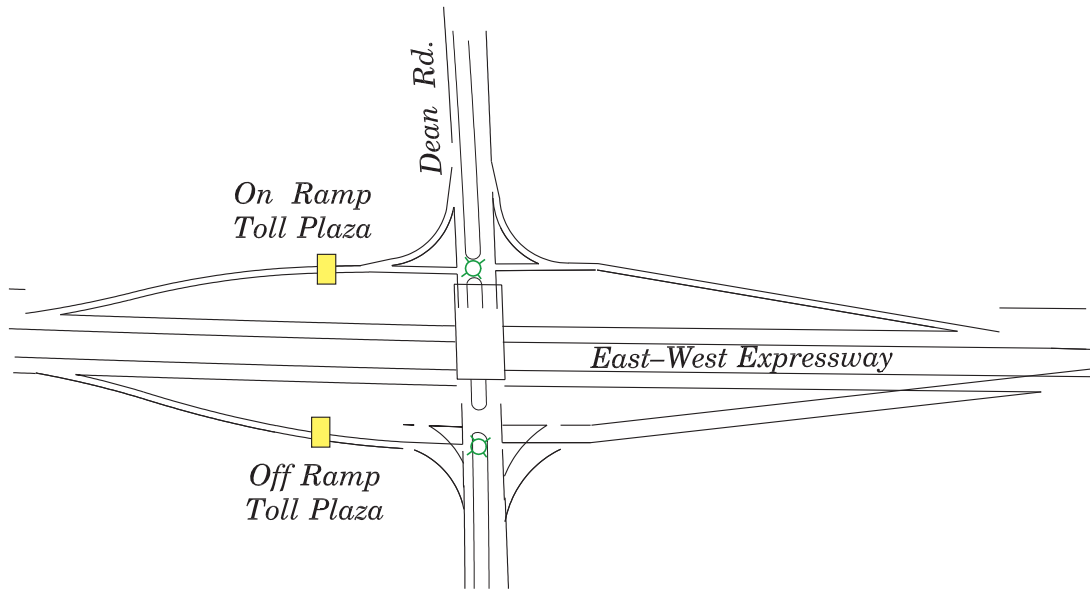

ORG-ID: 4  
 FACILITY: SR 408 - DEAN

\* Changeable Message Sign

Note: All Changeable Message Signs (CMS) can display three messages: EXACT COINS, CHANGE RECEIPTS, E-PASS ONLY

Reports to Dean Mainline Toll Plaza

T:\OCEA\OCEA MANUAL\STol Facilities Reference Book\2016 Tolls Manual - 3/10/16-CP

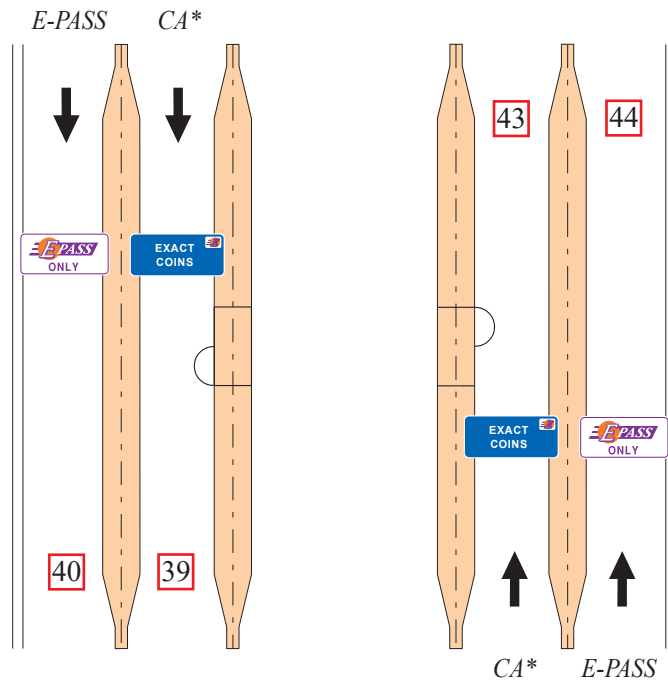
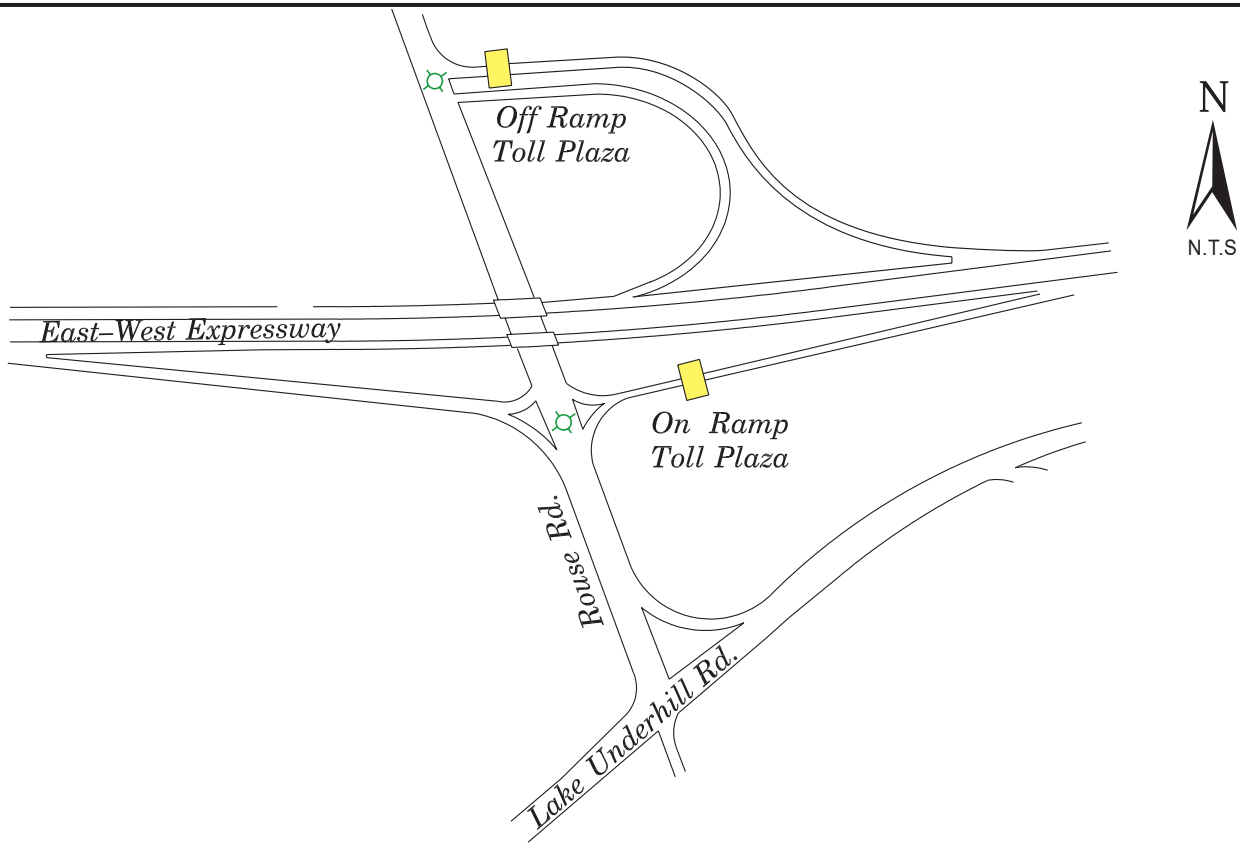

ORG-ID: 4  
 FACILITY: SR 408 - DEAN

\* Changeable Message Sign

Note: All Changeable Message Signs (CMS) can display three messages: EXACT COINS, CHANGE RECEIPTS, E-PASS ONLY

Reports to Dean Mainline Toll Plaza

T:\OCEA\OCEA MANUAL\STol Facilities Reference Book\2016 Tolls Manual - 3/10/16-CP

# John Land Apopka Expressway



## Mainline Toll Plazas and Associated Ramps

LEGEND

*For Lane Designations for all Plazas*

*CA - Exact Coin with E-PASS*

*MA - Change Receipts (Staffed) with E-PASS*

*MCA - Booth with Manual Lane Terminal,  
Automatic Coin Machine and E-PASS*

↑  
**To SR 429, Apopka**  
 Next Interchange: Marden Road  
 Next Mainline Plaza: None  
 Next Ramp Plaza: None

↓  
**To US 441, I-4, Maitland, US 17/92**  
 Next Interchange: Hiwassee Rd.  
 Next Mainline Plaza: None  
 Next Ramp Plaza: Hiwassee Rd.  
 EB-ON/WB-OFF

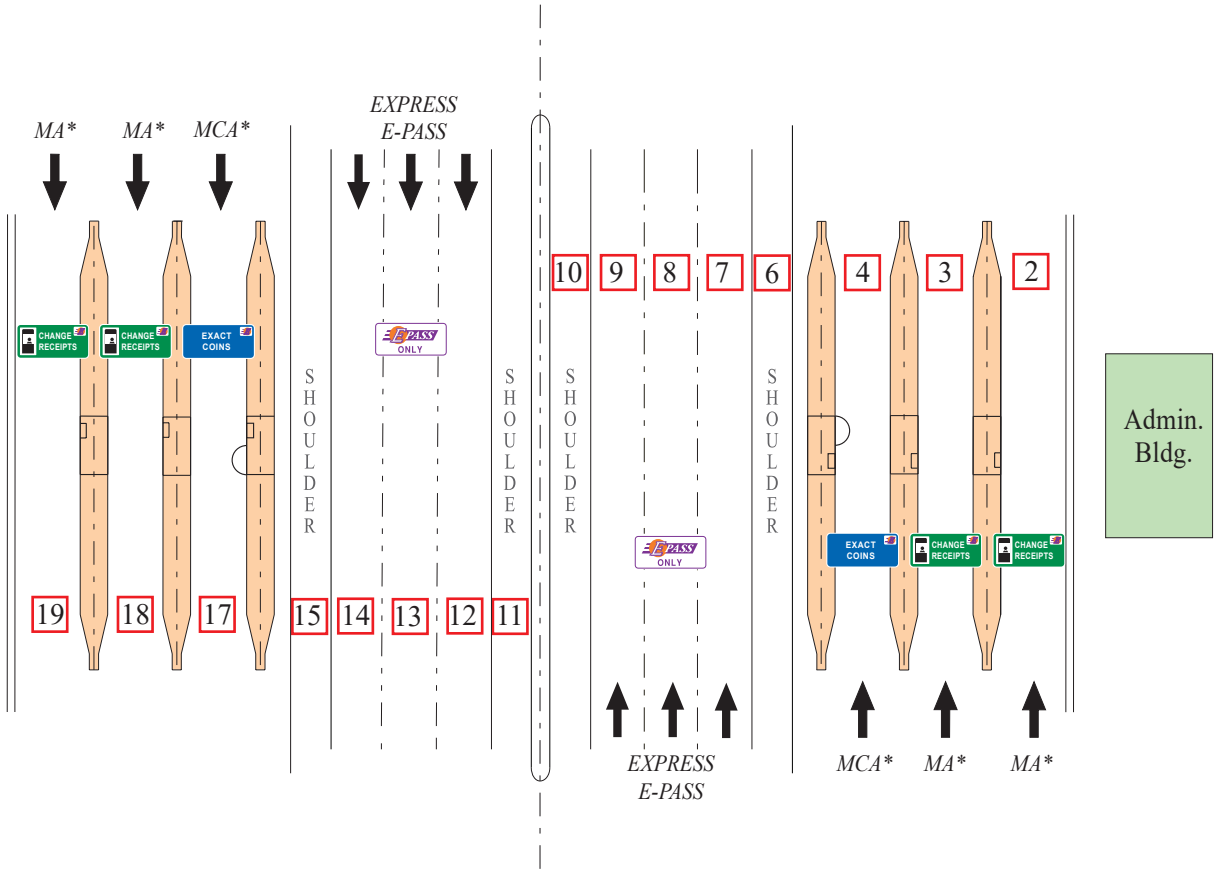

Note: All Changeable Message Signs (CMS) can display three messages: EXACT COINS, CHANGE RECEIPTS, E-PASS ONLY

ORG-ID: 14	PID: 401
FACILITY: SR 414 - CORAL HILLS	

LANES OF EQUIPMENT

- 6 Staffed Booths with E-PASS (MA)
- 2 Booths with ACM's and E-PASS
- 6 Express E-PASS (E-PASS only)
- \* Changeable Message Sign

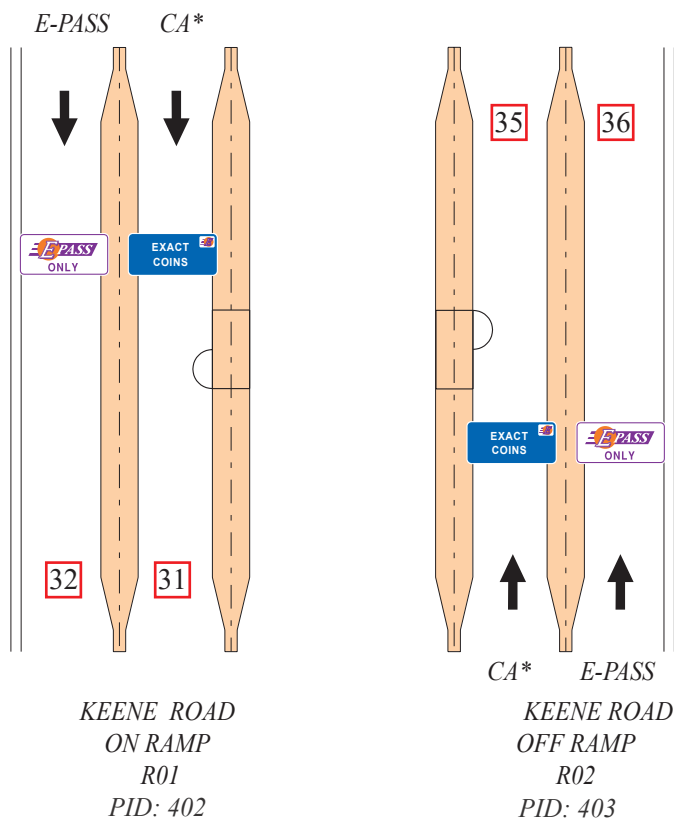
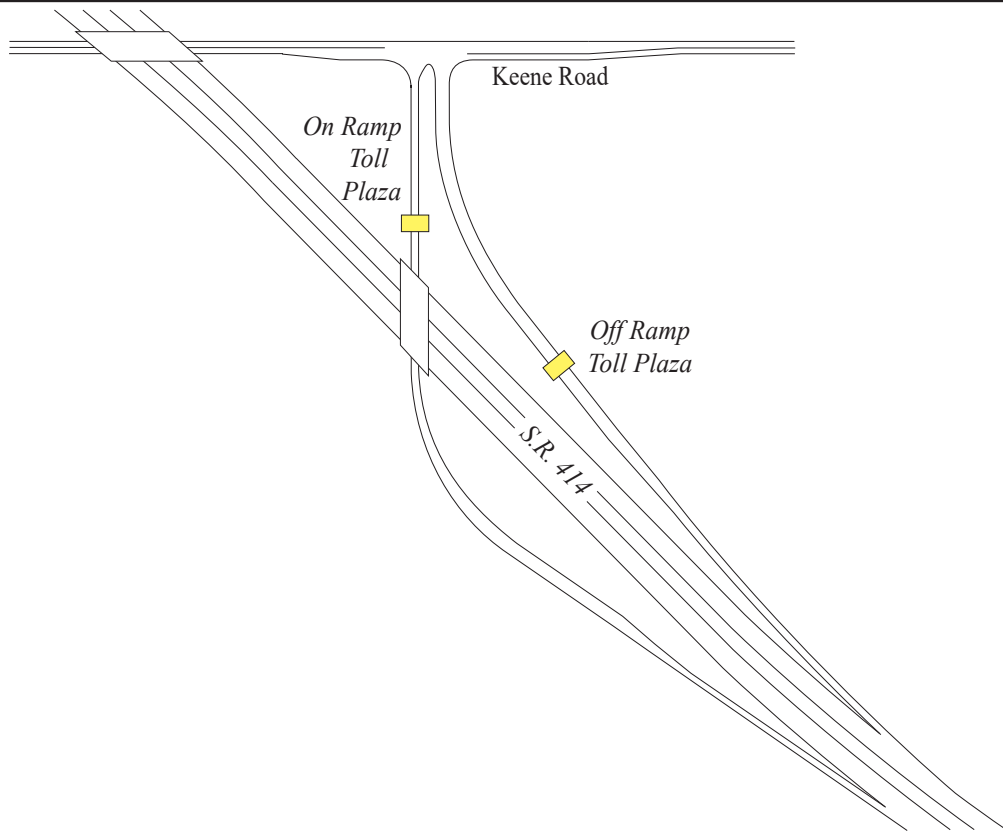

ORG-ID: 14  
 FACILITY: SR 414 - CORAL HILLS

\* Changeable Message Sign

Note: All Changeable Message Signs (CMS) can display three messages: EXACT COINS, CHANGE RECEIPTS, E-PASS ONLY

Reports to Coral Hills Mainline Toll Plaza

T:\OCEA\OCEA MANUAL\STol Facilities Reference Book\2016 Tolls Manual - 3/10/16-CP

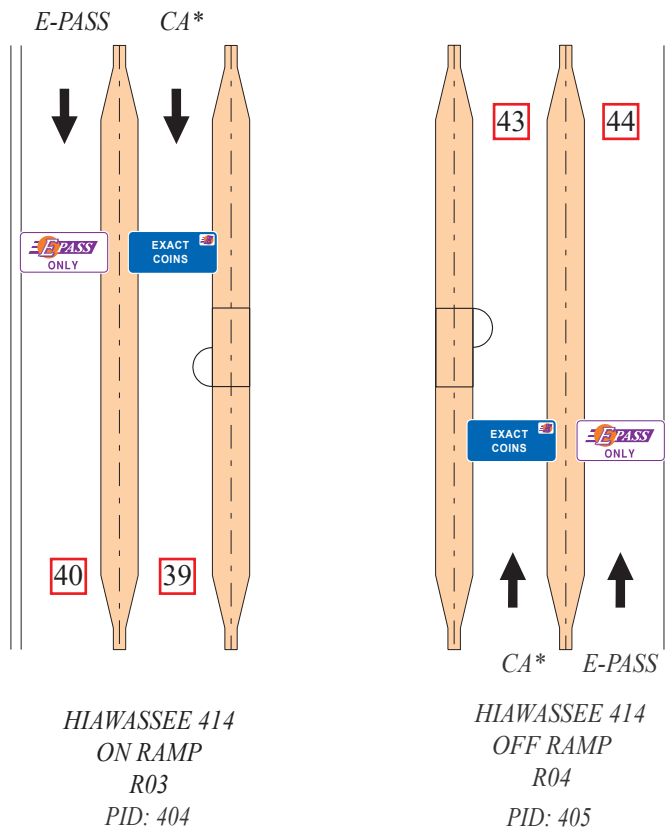
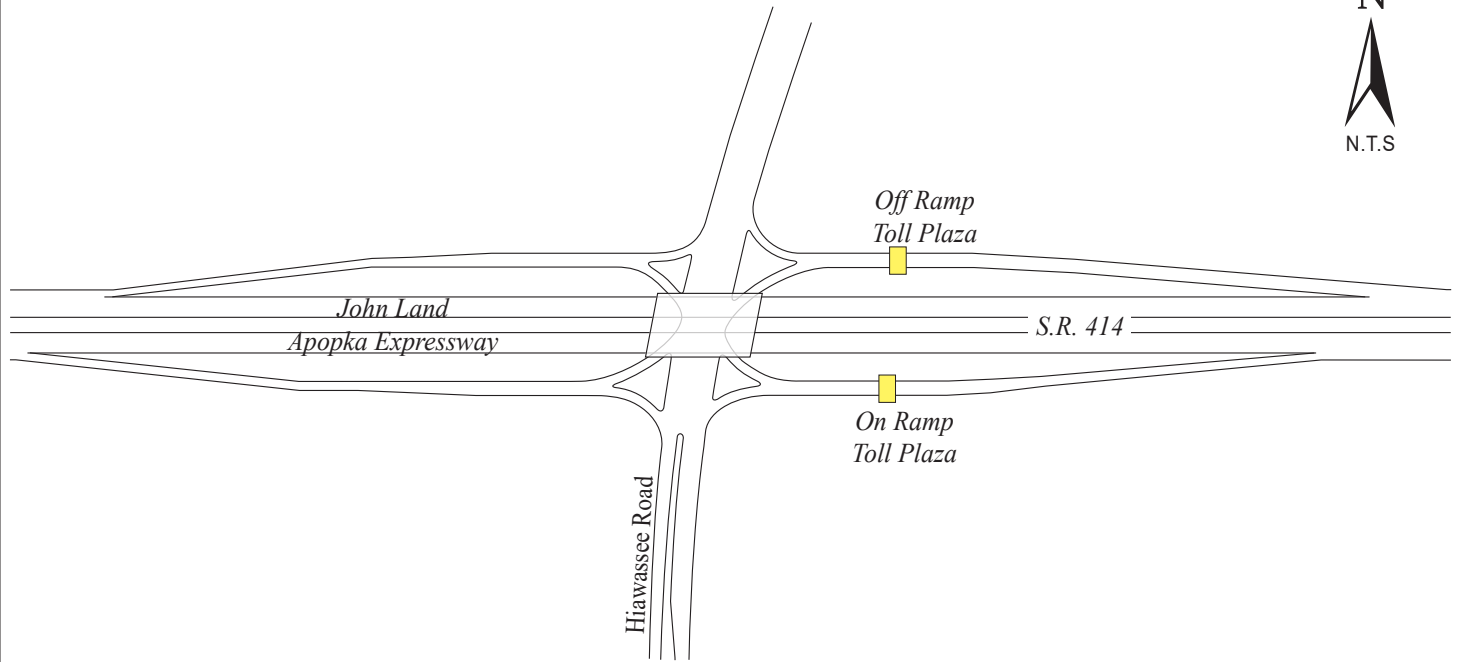

ORG-ID: 14  
 FACILITY: SR 414 - CORAL HILLS

\* Changeable Message Sign

Note: All Changeable Message Signs (CMS) can display three messages: EXACT COINS, CHANGE RECEIPTS, E-PASS ONLY

Reports to Coral Hills Mainline Toll Plaza

T:\OCEA\OCEA MANUALS\Toll Facilities Reference Book\2016 Tolls Manual - 3/10/16-CP

# Central Florida GreeneWay



## Mainline Toll Plazas and Associated Ramps

LEGEND

*For Lane Designations for all Plazas*

*CA - Exact Coin with E-PASS*

*MA - Change Receipts (Staffed) with E-PASS*

*MCA - Booth with Manual Lane Terminal,  
Automatic Coin Machine and E-PASS*



To International Drive & I-4 (Walt Disney World)

Next Interchange: International Drive  
 Next Mainline Plaza: Celebration Mainline (Turnpike)  
 Next Ramp Plaza: Osceola Parkway (Turnpike) SB-OFF/NB-ON

To Orlando Int'l Airport, SR 528 (Beachline), Sanford

Next Interchange: John Young Pkwy.  
 Next Mainline Plaza: Bogy Creek Mainline  
 Next Ramp Plaza: John Young Pkwy. NB-ON/SB-OFF

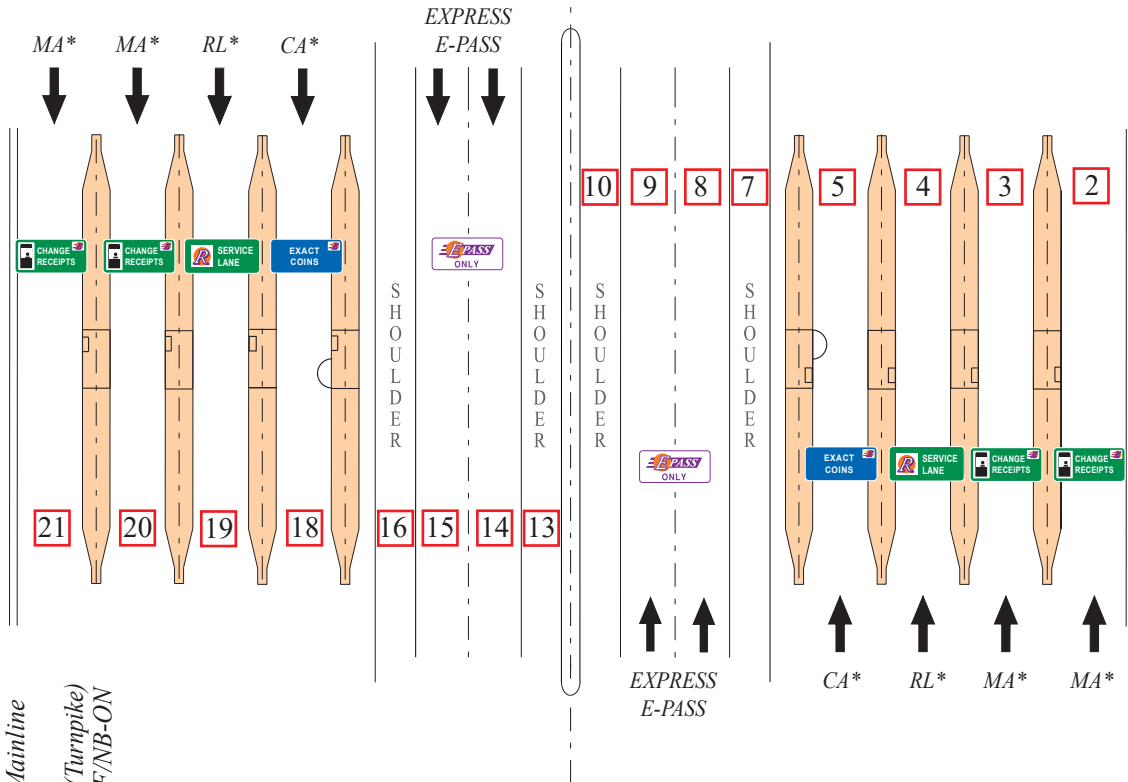

ORG-ID: 7	PID: 331
FACILITY: SR 417 - JOHN YOUNG	

- LANES OF EQUIPMENT
- 4 Staffed Booths with E-PASS (MA)
  - 2 Automatic Coin Machines (ACM) with E-PASS
  - 2 E-PASS Reload Lane (RL)
  - 4 Express E-PASS (E-PASS only)
  - \* Changeable Message Sign

Note: All Changeable Message Signs (CMS) can display three messages: EXACT COINS, CHANGE RECEIPTS, E-PASS ONLY



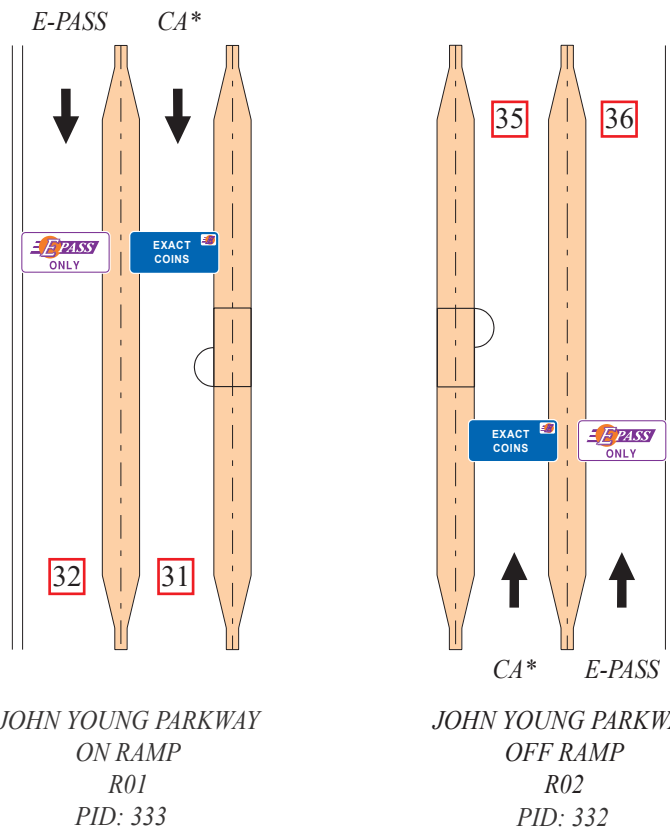
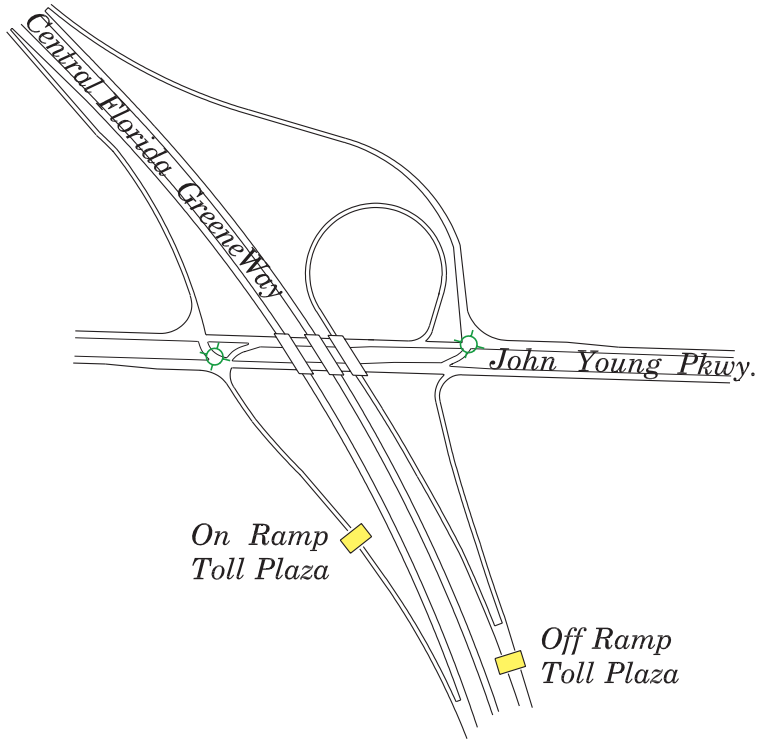

ORG-ID: 7  
 FACILITY: SR 417 - JOHN YOUNG

\* Changeable Message Sign

Note: All Changeable Message Signs (CMS) can display three messages: EXACT COINS, CHANGE RECEIPTS, E-PASS ONLY

Reports to John Young Mainline Toll Plaza

T:\OCEA\OCEA MANUAL\STol Facilities Reference Book\2016 Tolls Manual - 3/10/16-CP

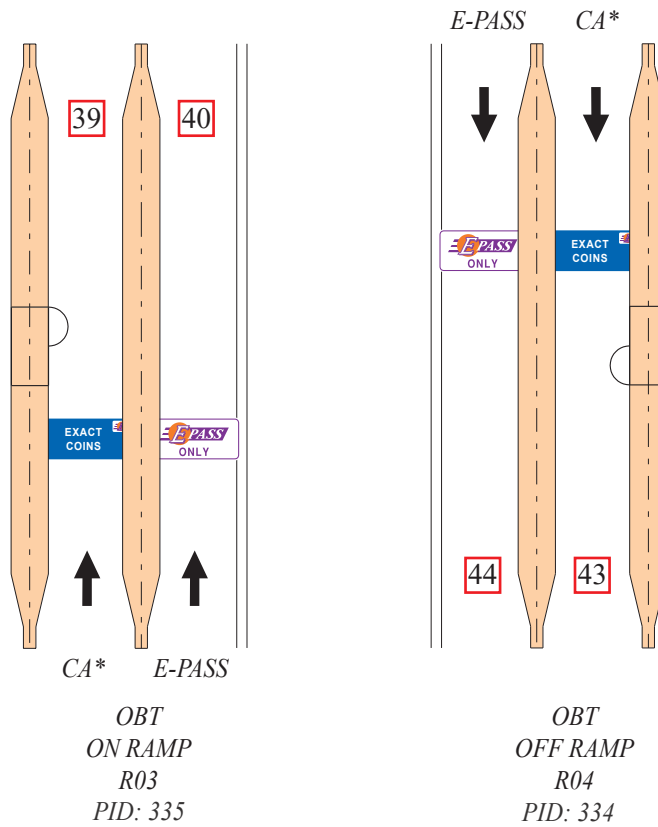
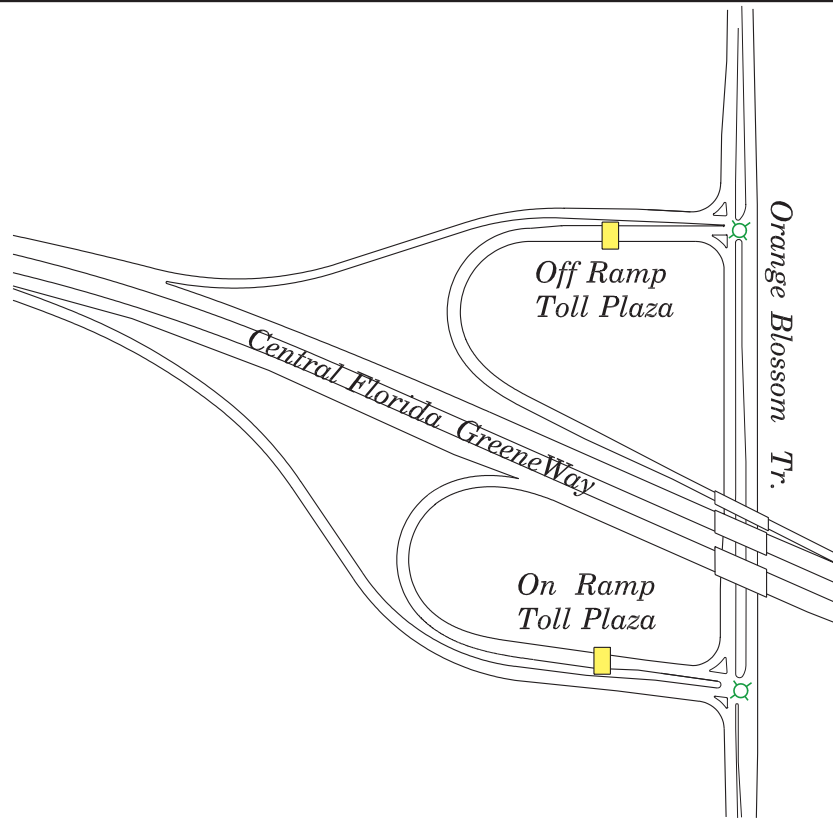

ORG-ID: 7  
 FACILITY: SR 417 - JOHN YOUNG

\* Changeable Message Sign

Note: All Changeable Message Signs (CMS) can display three messages: EXACT COINS, CHANGE RECEIPTS, E-PASS ONLY

Reports to John Young Mainline Toll Plaza

T:\DOCEA\DOCEA MANUAL\STol Facilities Reference Book\2016 Tolls Manual - 3/10/16-CP

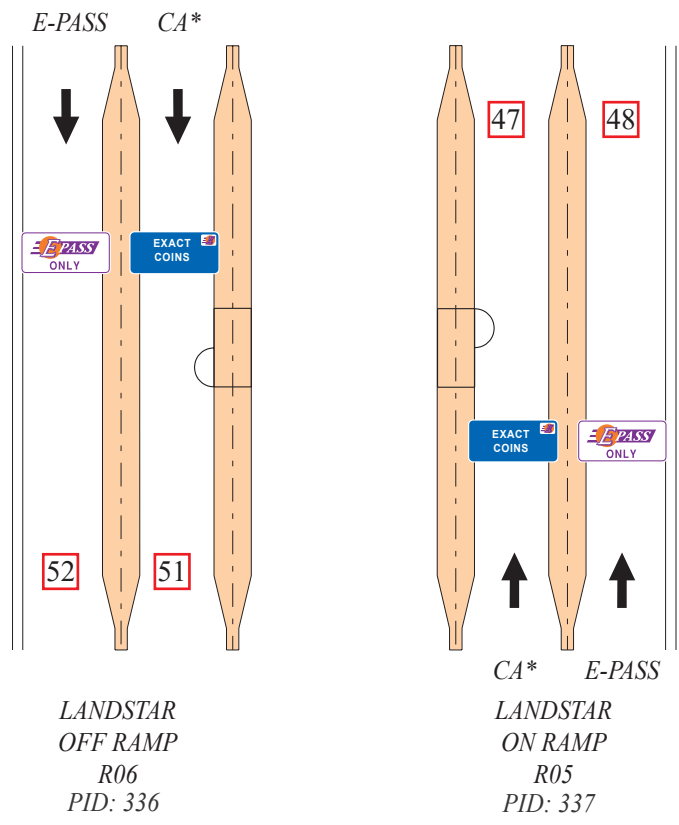
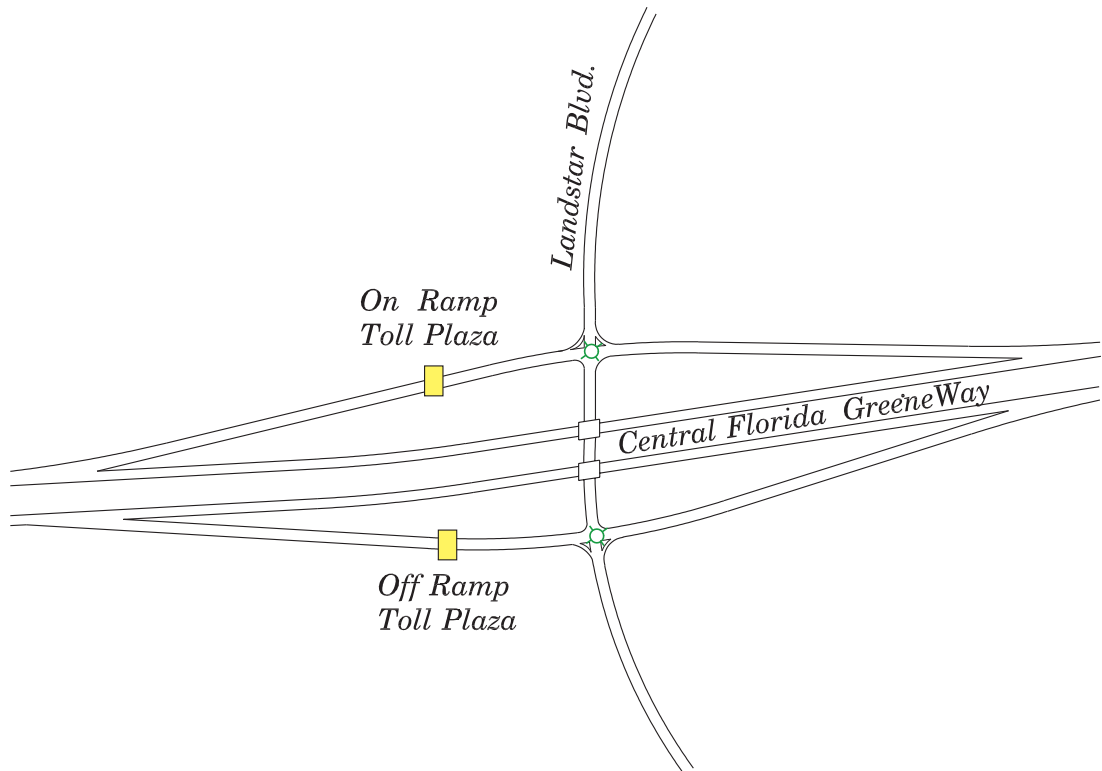

ORG-ID: 7  
 FACILITY: SR 417 - JOHN YOUNG

*Note: All Changeable Message Signs (CMS) can display three messages: EXACT COINS, CHANGE RECEIPTS, E-PASS ONLY*

*Reports to John Young Mainline Toll Plaza*

T:\OCEA\OCEA MANUAL\STol Facilities Reference Book\2016 Tolls Manual - 3/10/16-CP



To Orlando Int'l. Airport,  
SR 528 (Beachline), Sanford

Next Interchange: Bogy Creek Rd.  
Next Mainline Plaza: Curry Ford Mainline  
Next Ramp Plaza: Bogy Creek/OIA Access  
NB-ON/SB-OFF

To International Drive & I-4  
(Walt Disney World Area)

Next Interchange: Landstar Blvd.  
Next Mainline Plaza: John Young Mainline  
Next Ramp Plaza: Landstar  
SB-ON/NB-OFF

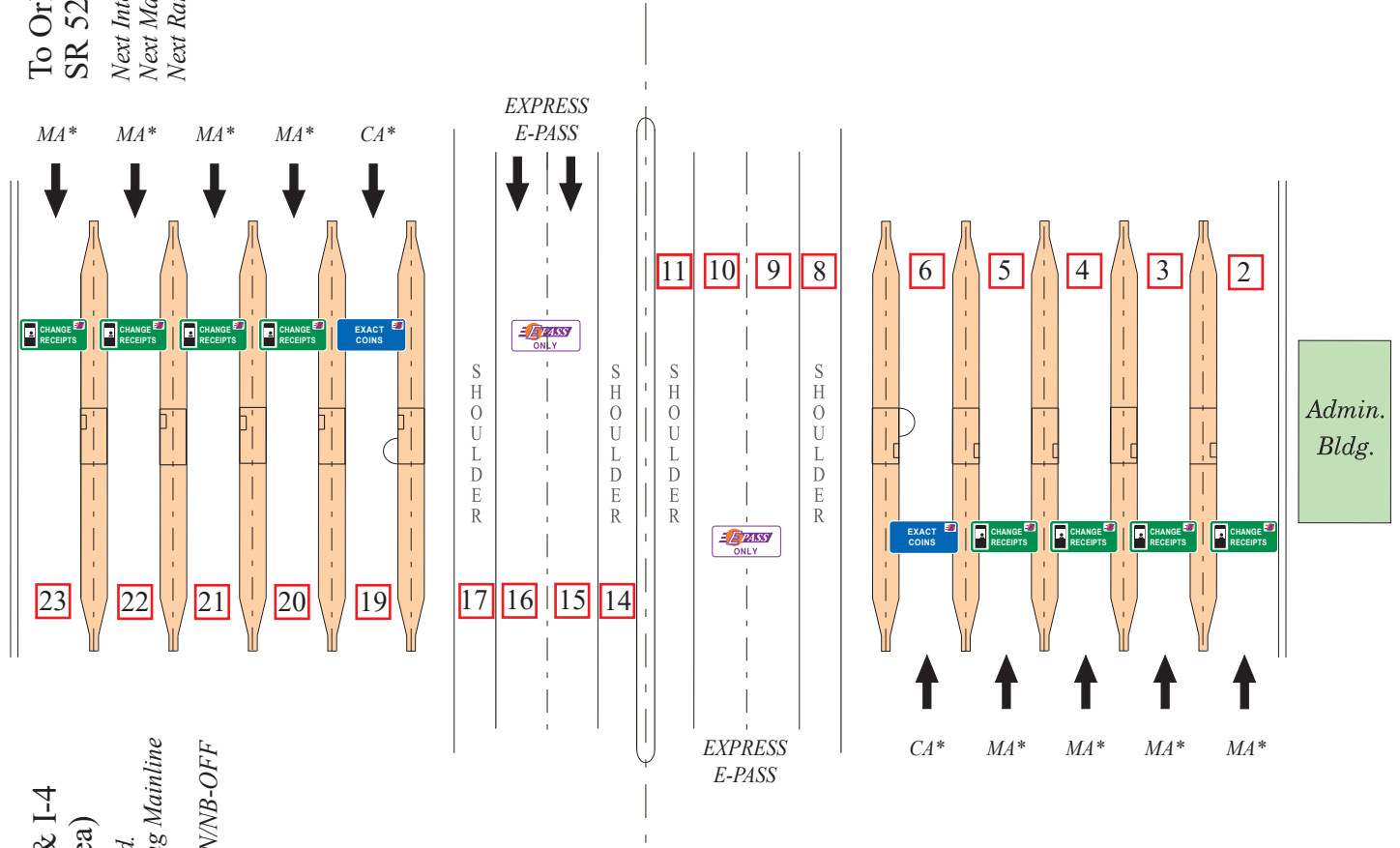

ORG-ID: 8                      PID: 338  
FACILITY: SR 417 - BOGGY CREEK

- LANES OF EQUIPMENT
- 8 Staffed Booths with E-PASS (MA)
  - 2 Exact Coin with E-PASS
  - 4 Express E-PASS
  - \* Changeable Message Sign

Note: All Changeable Message Signs (CMS) can display three messages: EXACT COINS, CHANGE RECEIPTS, E-PASS ONLY

T:\OCEA\OCEA MANUAL\STol Facilities Reference Book\2016 Tolls Manual - 3/10/16-CP

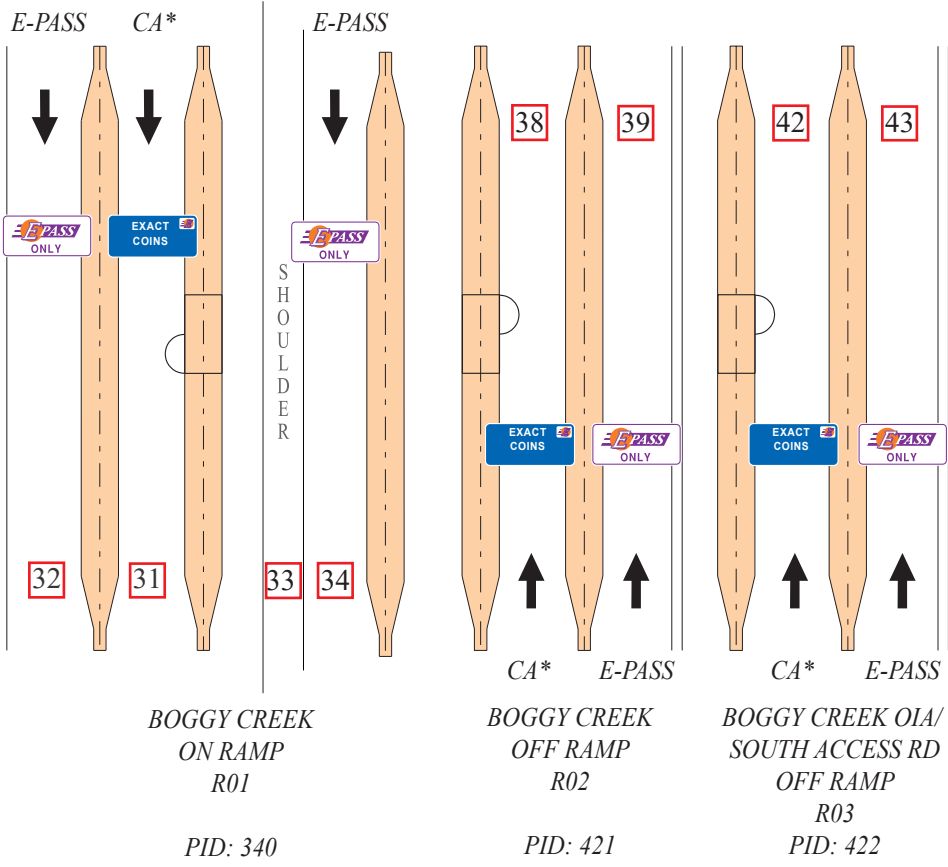
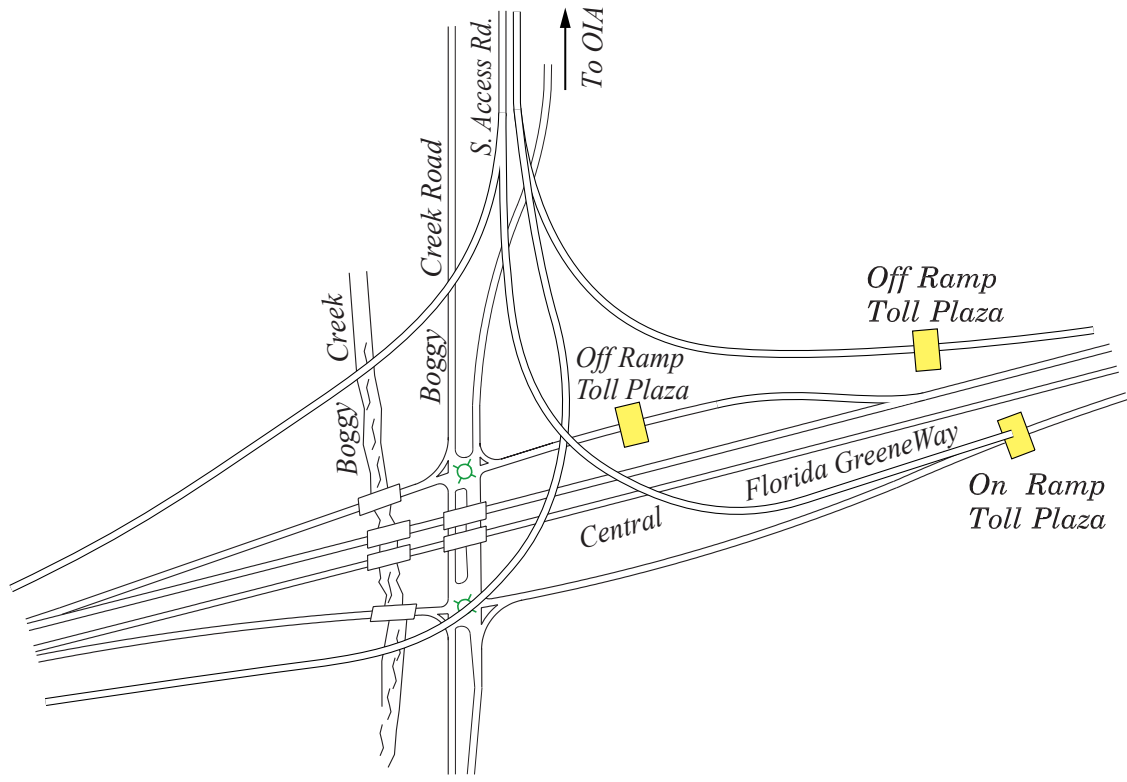

ORG-ID: 8  
 FACILITY: SR 417 - BOGGY CREEK

\* Changeable Message Sign (ACM/CA)

Note: All Changeable Message Signs (CMS) can display three messages: EXACT COINS, CHANGE RECEIPTS, E-PASS ONLY

BOGGY CREEK ON RAMP R01 PID: 340  
 BOGGY CREEK OFF RAMP R02 PID: 421  
 BOGGY CREEK OIA/SOUTH ACCESS RD OFF RAMP R03 PID: 422

Reports to Boggy Creek Mainline Toll Plaza

T:\OCEA\OCEA MANUAL\STol Facilities Reference Book\2016 Tolls Manual - 3/10/16-CP

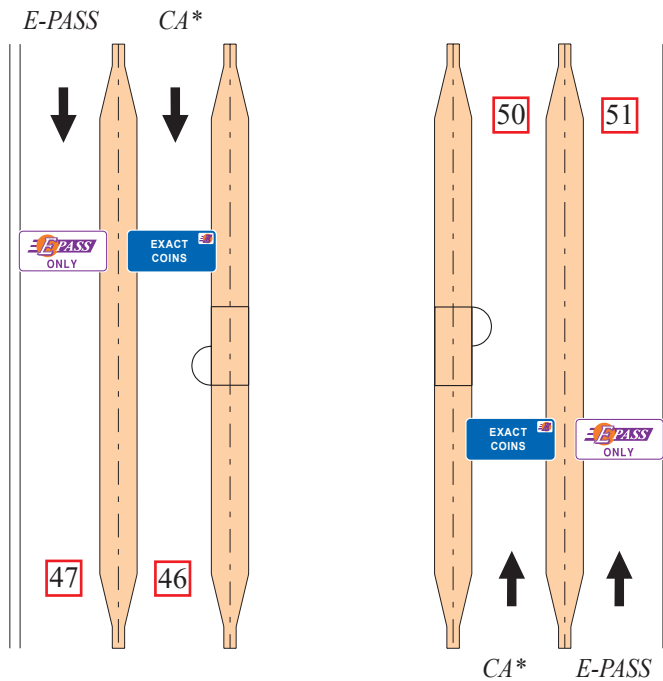
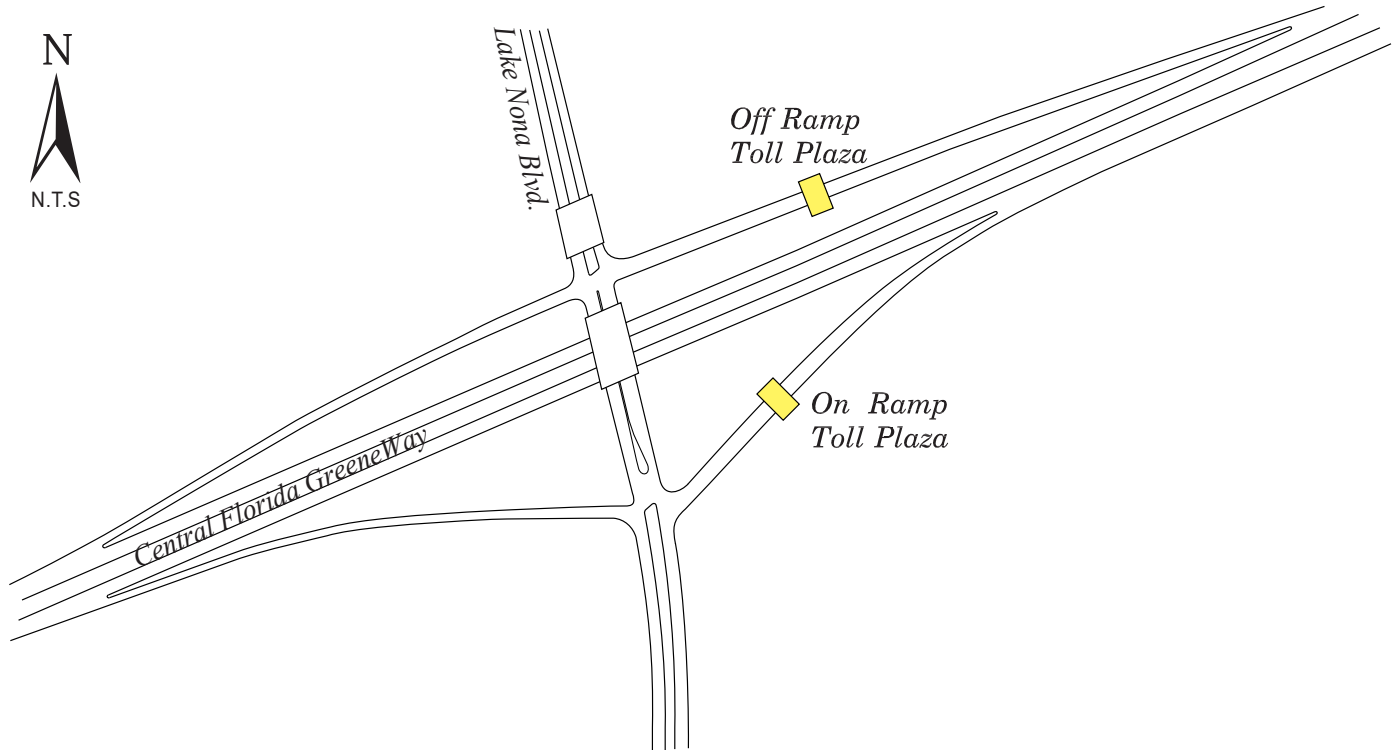

ORG-ID: 8  
FACILITY: SR 417 - BOGGY CREEK

\* Changeable Message Sign

Note: All Changeable Message Signs (CMS) can display three messages: EXACT COINS, CHANGE RECEIPTS, E-PASS ONLY

LAKE NONA  
ON RAMP  
R04  
PID: 380

LAKE NONA  
OFF RAMP  
R05  
PID: 381

Reports to Boggy Creek Mainline Toll Plaza

T:\OCEA\OCEA MANUAL\STol Facilities Reference Book\2016 Tolls Manual - 3/10/16-CP

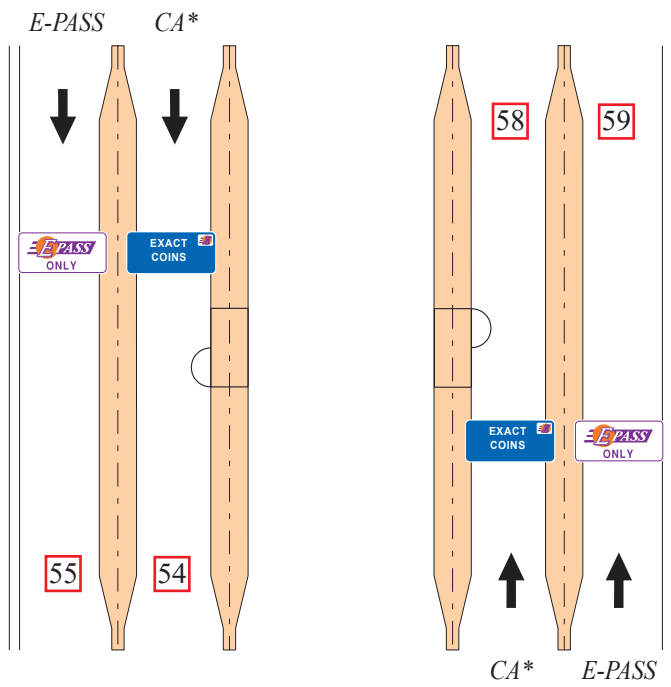
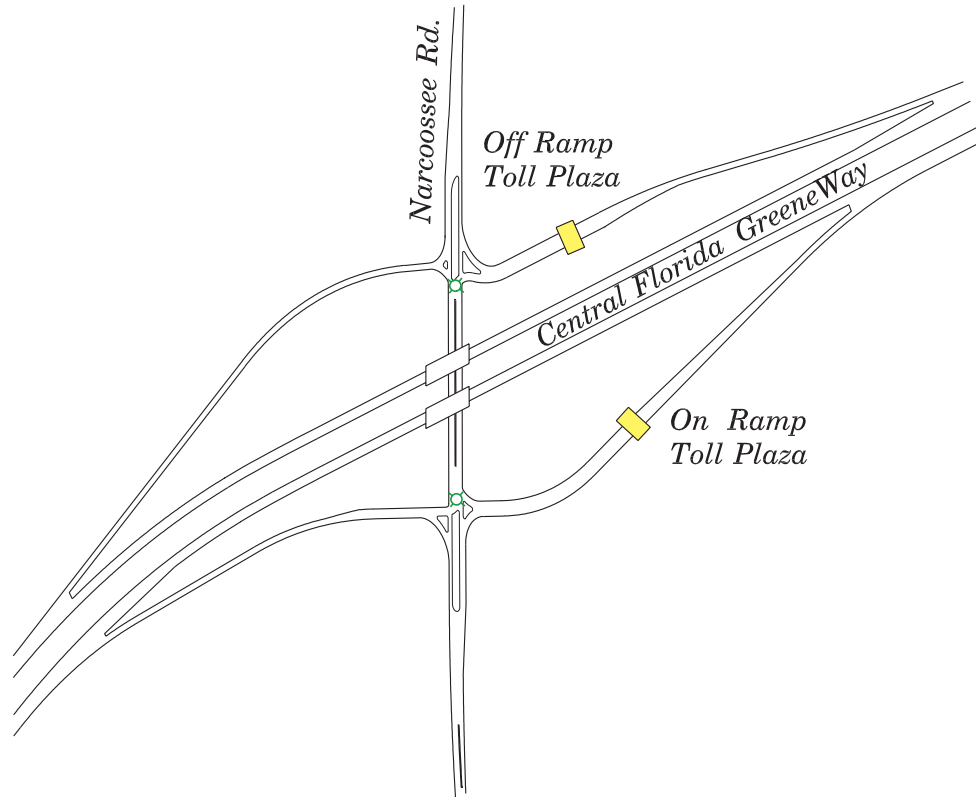

ORG-ID: 8  
 FACILITY: SR 417 - BOGGY CREEK

\* Changeable Message Sign

Note: All Changeable Message Signs (CMS) can display three messages: EXACT COINS, CHANGE RECEIPTS, E-PASS ONLY

NARCOOSSEE ON RAMP R06 PID: 342  
 NARCOOSSEE OFF RAMP R07 PID: 341

Reports to Boggy Creek Mainline Toll Plaza

T:\OCEA\OCEA MANUAL\STol Facilities Reference Book\2016 Tolls Manual - 3/10/16-CP

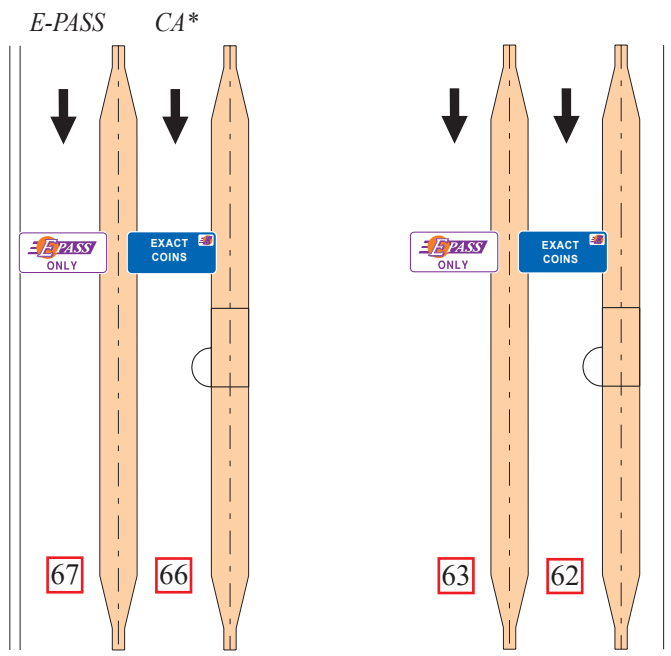
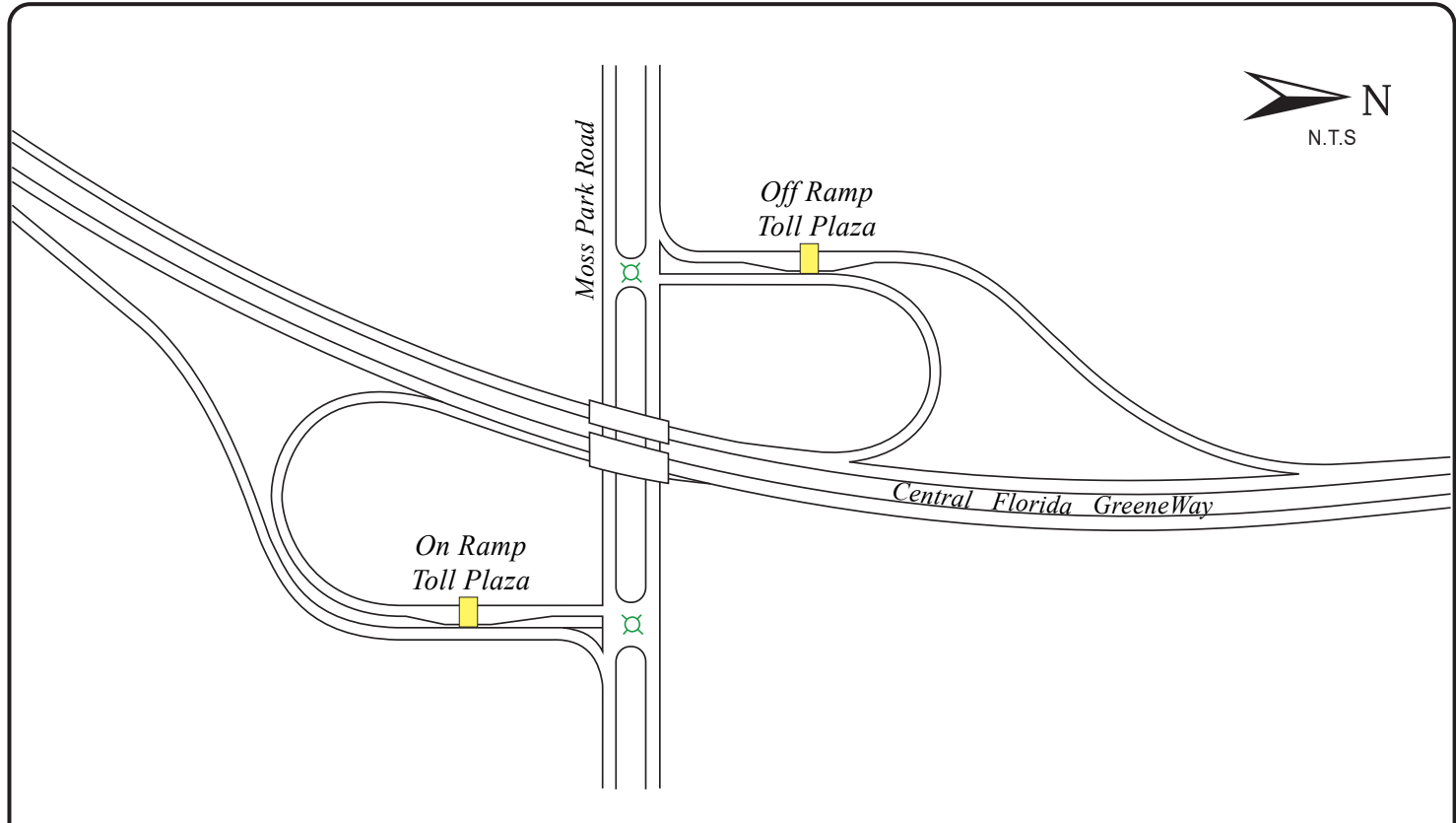

ORG-ID: 8  
 FACILITY: SR 417 - BOGGY CREEK

MOSS PARK  
 OFF RAMP  
 R09  
 PID: 411

E-PASS CA\*  
 MOSS PARK  
 ON RAMP  
 R08  
 PID: 410

\* Changeable Message Sign

Note: All Changeable Message Signs (CMS) can display three messages: EXACT COINS, CHANGE RECEIPTS, E-PASS ONLY

Reports to Boggy Creek Mainline Toll Plaza

T:\OCEA\OCEA MANUAL\STol Facilities Reference Book\2016 Tolls Manual - 3/10/16-CP



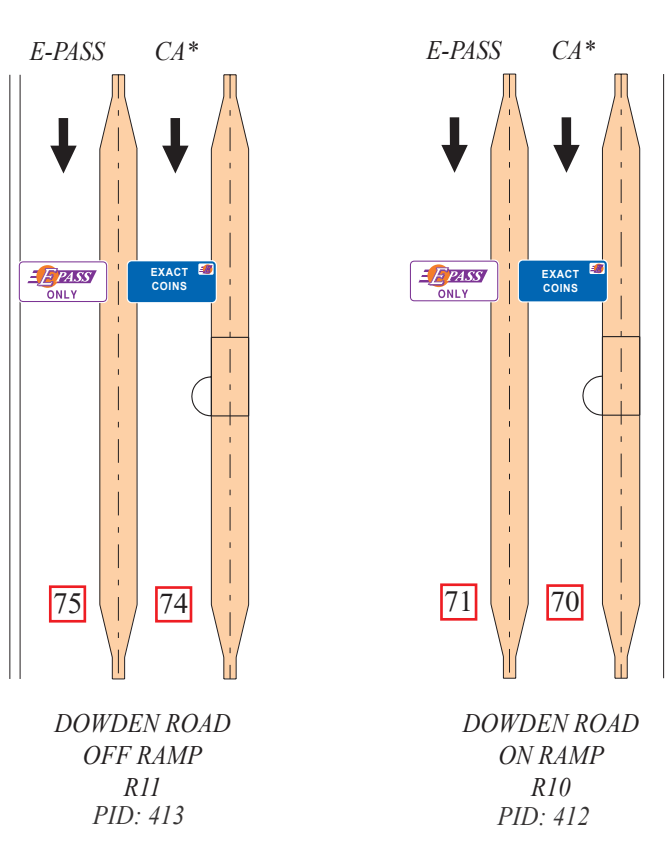
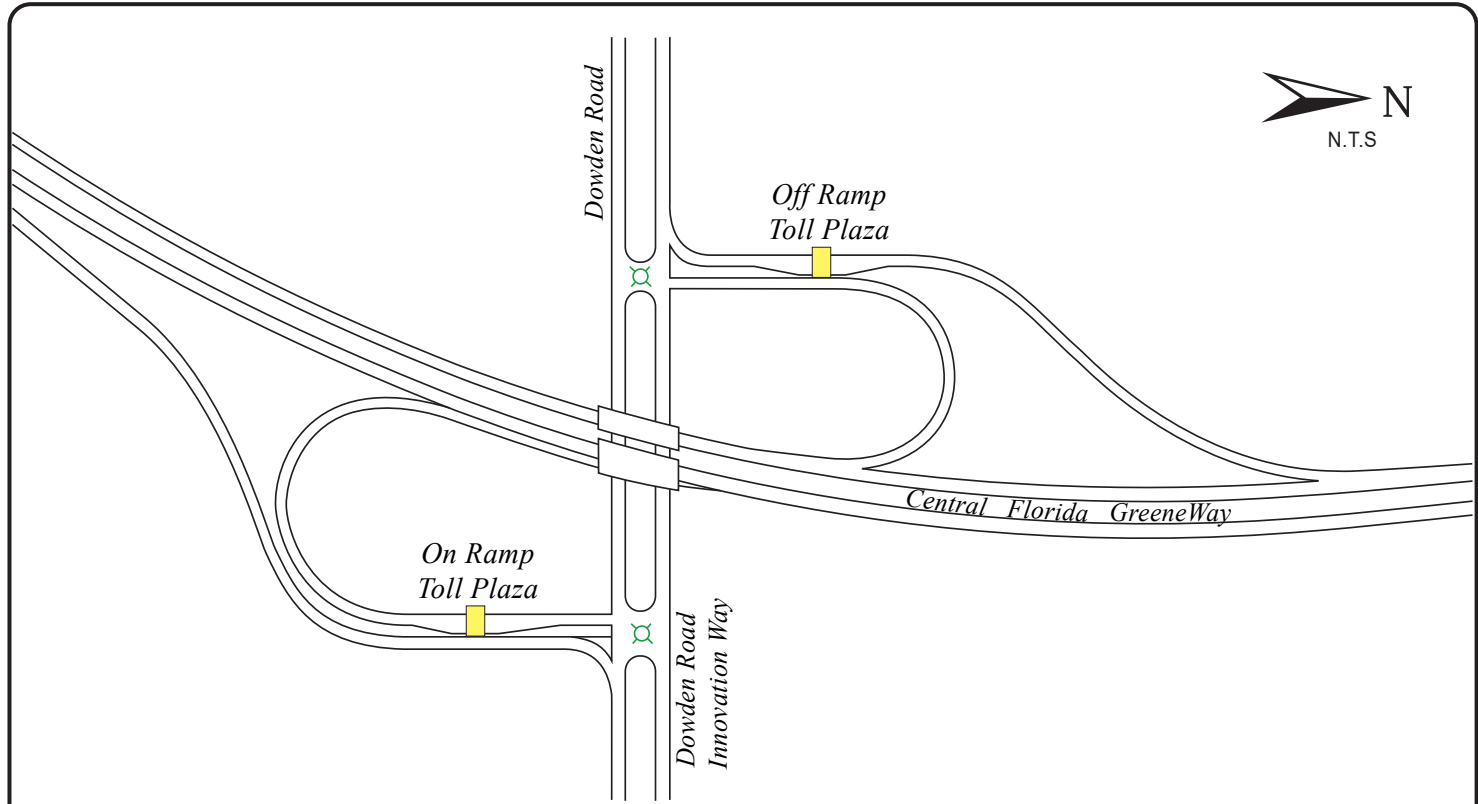

ORG-ID: 8  
 FACILITY: SR 417 - BOGGY CREEK

\* Changeable Message Sign

Note: All Changeable Message Signs (CMS) can display three messages: EXACT COINS, CHANGE RECEIPTS, E-PASS ONLY

Reports to Bogy Creek Mainline Toll Plaza

T:\OCEA\OCEA MANUAL\STol Facilities Reference Book\2016 Tolls Manual - 3/10/16-CP

↑  
**To SR 408 (East-West Expressway, SR 50 & Sanford)**  
 Next Interchange: Curry Ford Road  
 Next Mainline Plaza: University Mainline  
 Next Ramp Plaza: Curry Ford Road  
 NB-ON/SB-OFF



↓  
**To SR 528 (Beachline) Orlando International Airport & I-4 (Walt Disney World)**  
 Next Interchange: Lee Vista Boulevard  
 Next Mainline Plaza: Boggy Creek Mainline  
 Next Ramp Plaza: Lee Vista Boulevard  
 NB-OFF/SB-ON

Admin. Bldg.

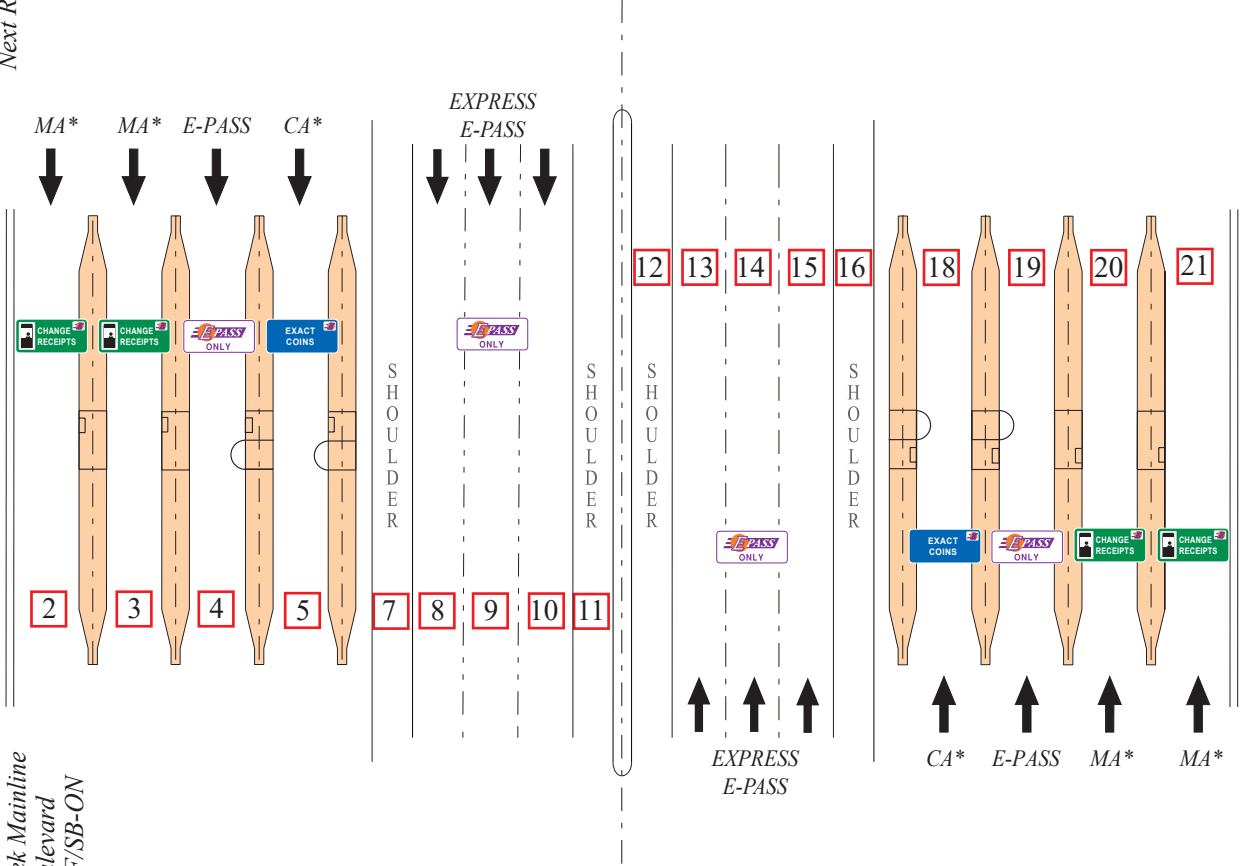

Note: All Changeable Message Signs (CMS) can display three messages: EXACT COINS, CHANGE RECEIPTS, E-PASS ONLY

ORG-ID: 6	PID: 328
FACILITY: SR 417 - CURRY FORD	

- LANES OF EQUIPMENT
- 6 Express E-PASS (E-PASS only)
  - 2 Booths with Automatic Coin Machines with E-PASS (ACM)
  - 4 Staffed Booths with E-PASS (MA)
  - \* Changeable Message Sign

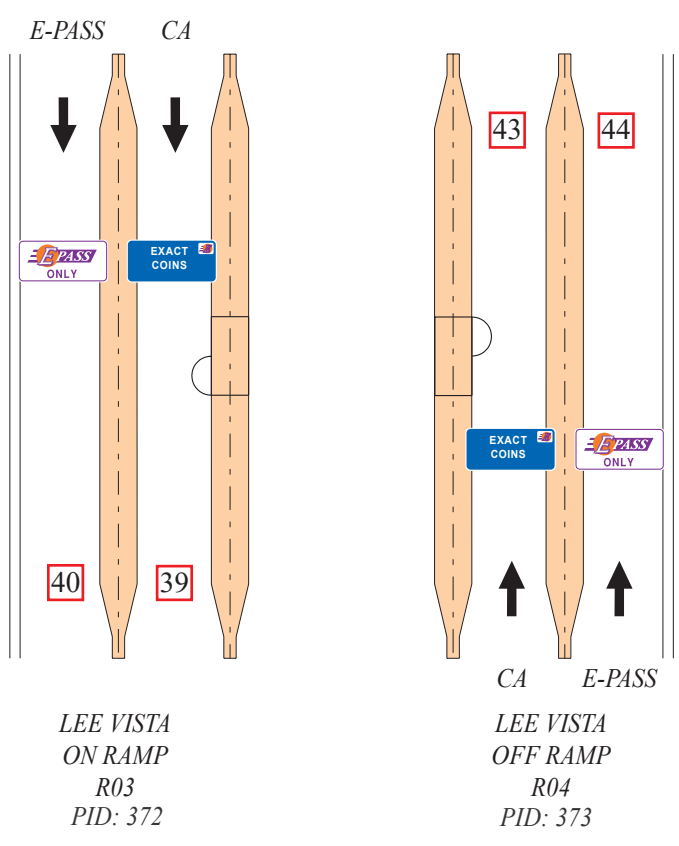
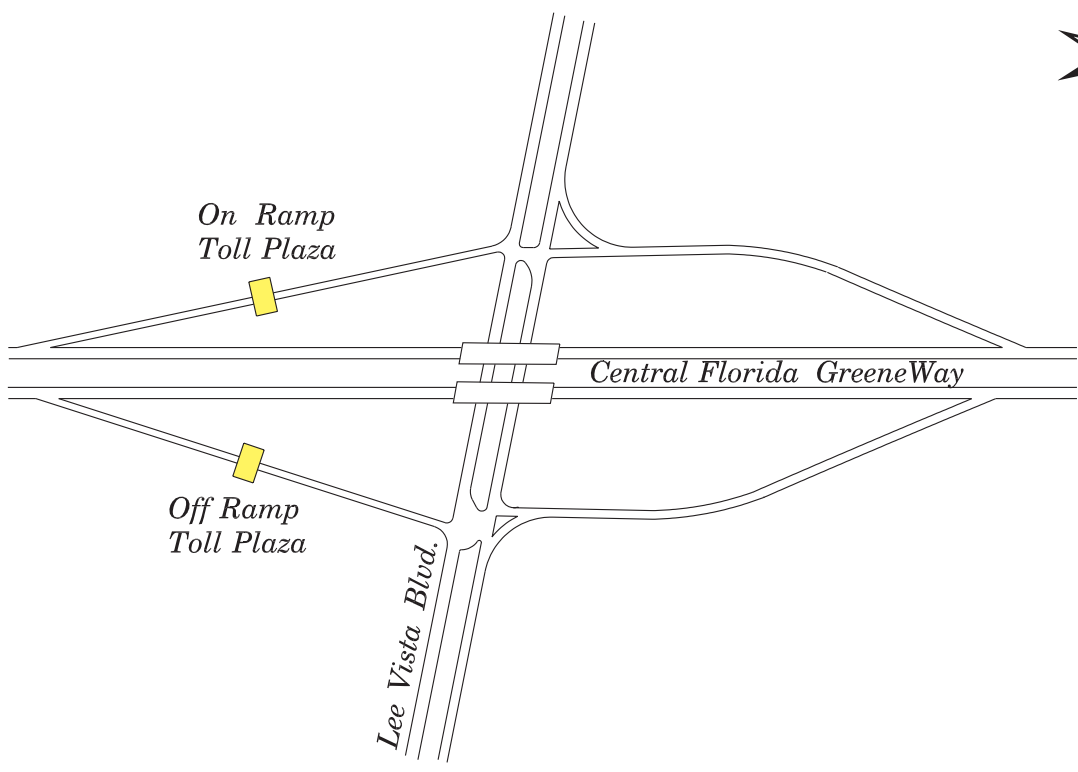

ORG-ID: 6  
 FACILITY: SR 417 - CURRY FORD

Reports to Curry Ford Mainline Toll Plaza

T:\OCEA\OCEA MANUAL\STol Facilities Reference Book\2016 Tolls Manual - 3/10/16-CP

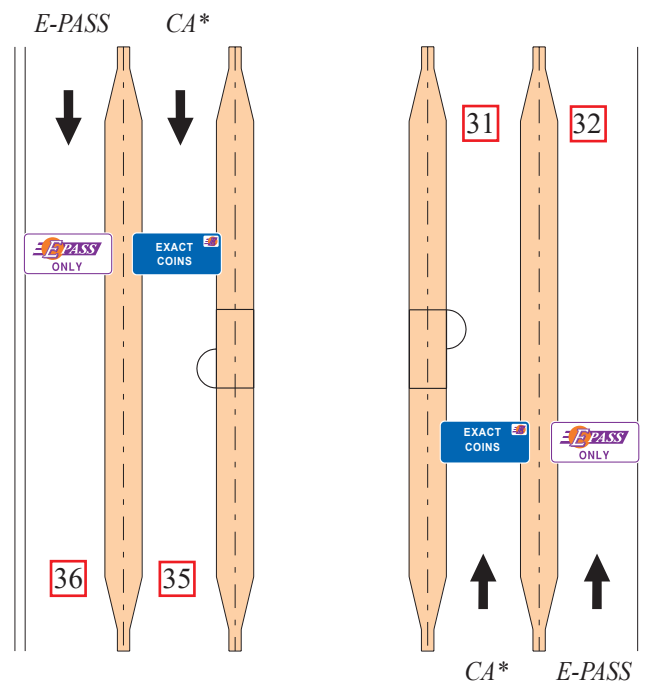
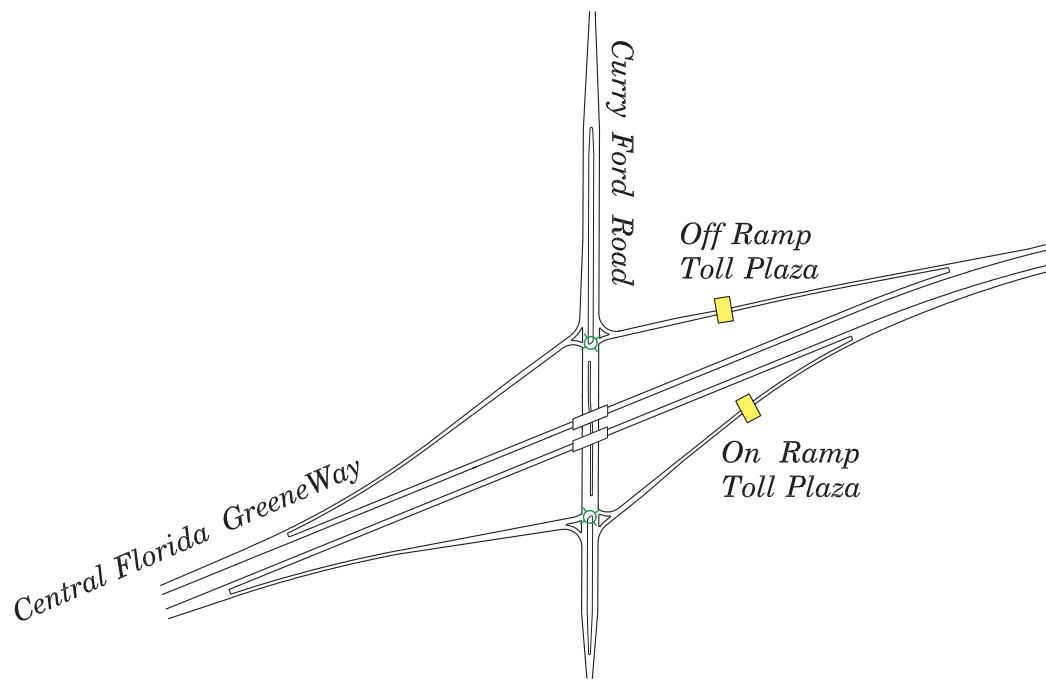

ORG-ID: 6  
 FACILITY: SR 417 - CURRY FORD

CURRY FORD  
 OFF RAMP  
 R02  
 PID: 330

CURRY FORD  
 ON RAMP  
 R01  
 PID: 329

\* Changeable Message Sign

Note: All Changeable Message Signs (CMS) can display three messages: EXACT COINS, CHANGE RECEIPTS, E-PASS ONLY

Reports to Curry Ford Mainline Toll Plaza

T:\OCEA\OCEA MANUAL\STol Facilities Reference Book\2016 Tolls Manual - 3/10/16-CP



To US 17, 92 & US 441

Next Interchange: University Boulevard  
 Next Mainline Plaza: Lake Jessup Mainline (Turnpike)  
 Next Ramp Plaza: Aloma Ave. (Turnpike)  
 NB-OFF/SB-ON

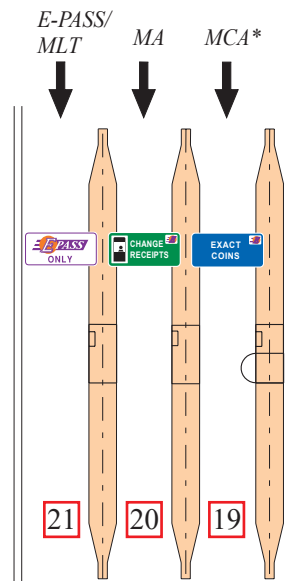

To SR 50 (Colonial Drive), SR 408 & SR 528  
 Next Interchange: SR 50  
 Next Mainline Plaza: Curry Ford Mainline  
 Next Ramp Plaza: SR 50 (Colonial Drive)  
 NB-OFF/SB-ON

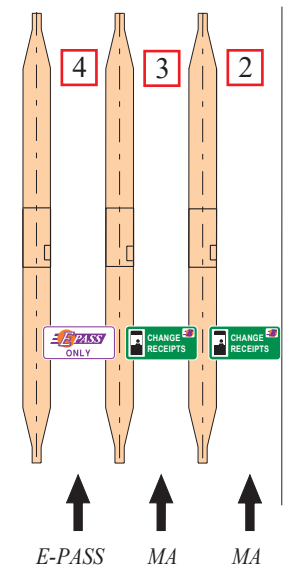
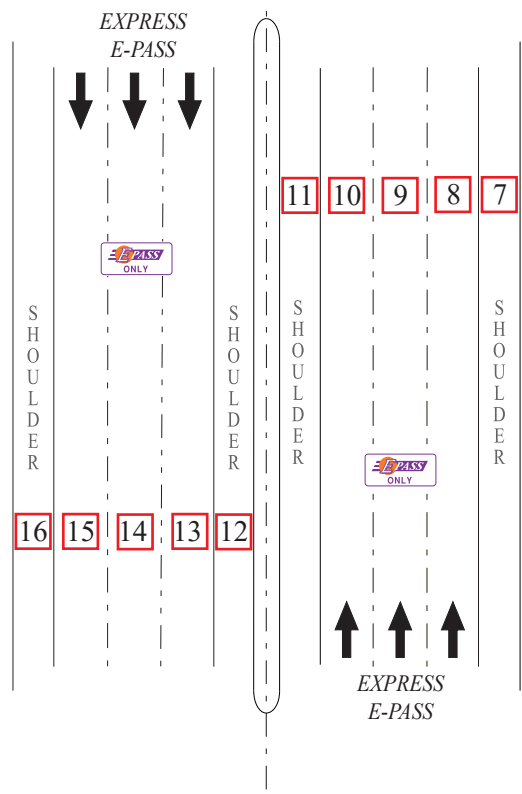

Admin. Bldg.

Note: All Changeable Message Signs (CMS) can display three messages: EXACT COINS, CHANGE RECEIPTS, E-PASS ONLY

ORG-ID: 3 PID: 301  
 FACILITY: SR 417 - UNIVERSITY

LANES OF EQUIPMENT

- 6 Express E-PASS (E-PASS only)
- 1 Booths with Automated Coin Machines with E-PASS (ACM)
- 5 Staffed Booths with E-PASS (MA)
- 2 Booth with E-PASS
- \* Changeable Message Sign

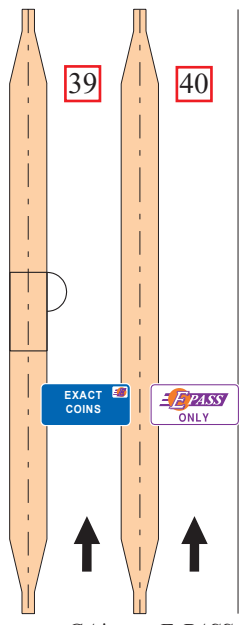
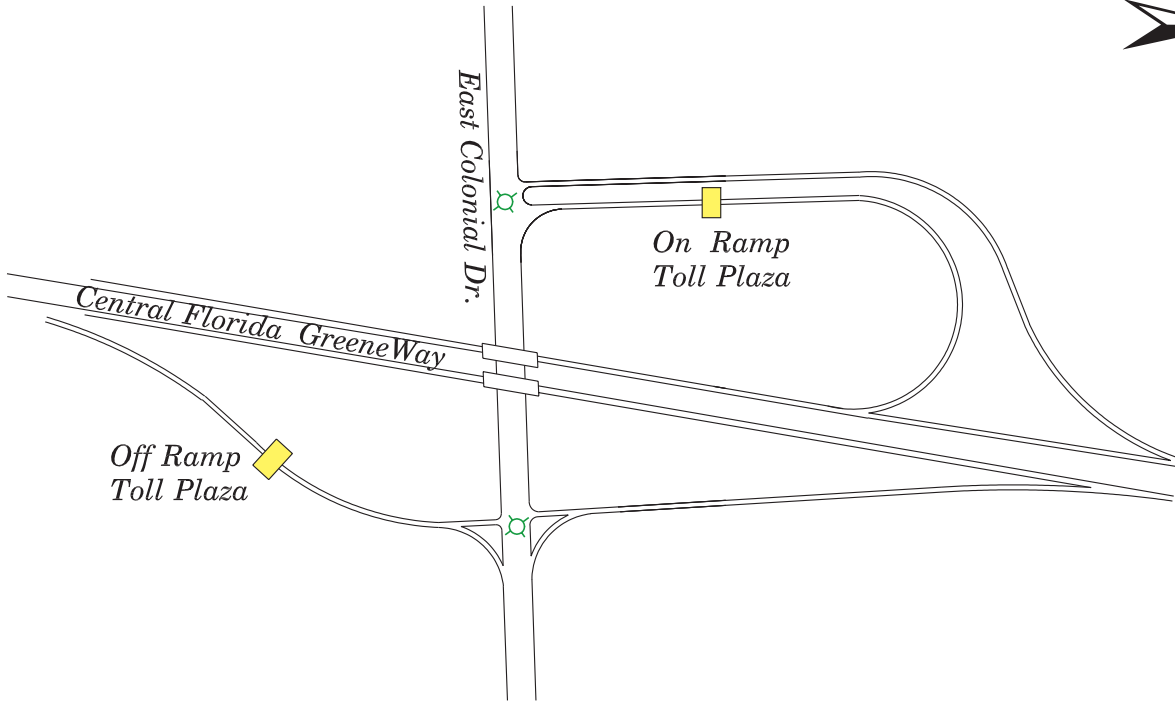

EAST COLONIAL  
ON RAMP  
R03  
PID: 304

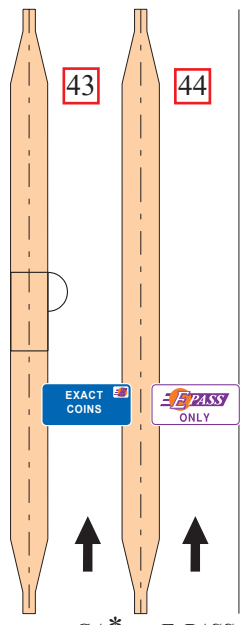

EAST COLONIAL  
OFF RAMP  
R04  
PID: 305

ORG-ID: 3  
FACILITY: SR 417 - UNIVERSITY

\* Changeable Message Sign

Note: All Changeable Message Signs (CMS) can display three messages: EXACT COINS, CHANGE RECEIPTS, E-PASS ONLY

Reports to University Mainline Toll Plaza

T:\OCEA\OCEA MANUAL\STol Facilities Reference Book\2016 Tolls Manual - 3/10/16-CP

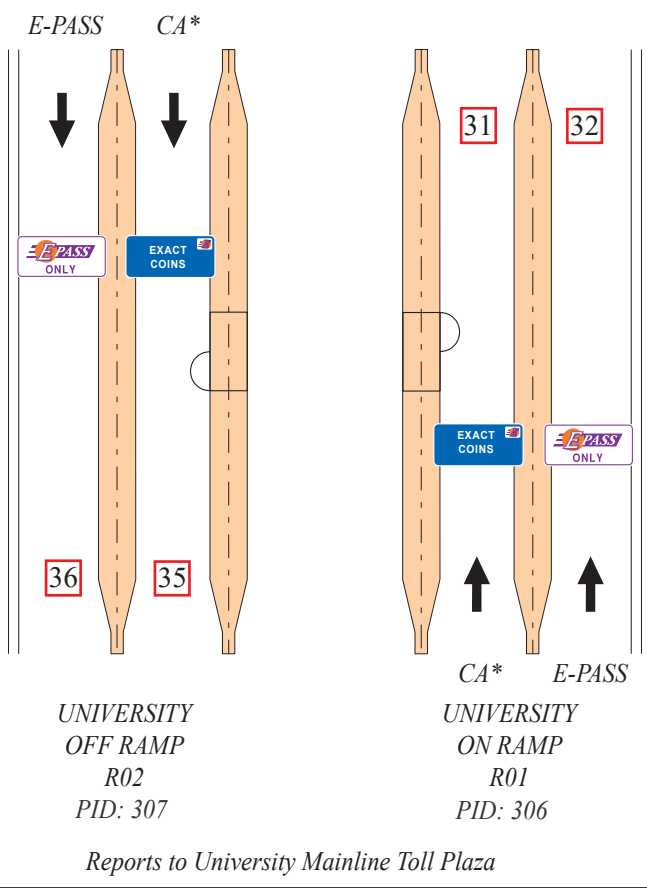
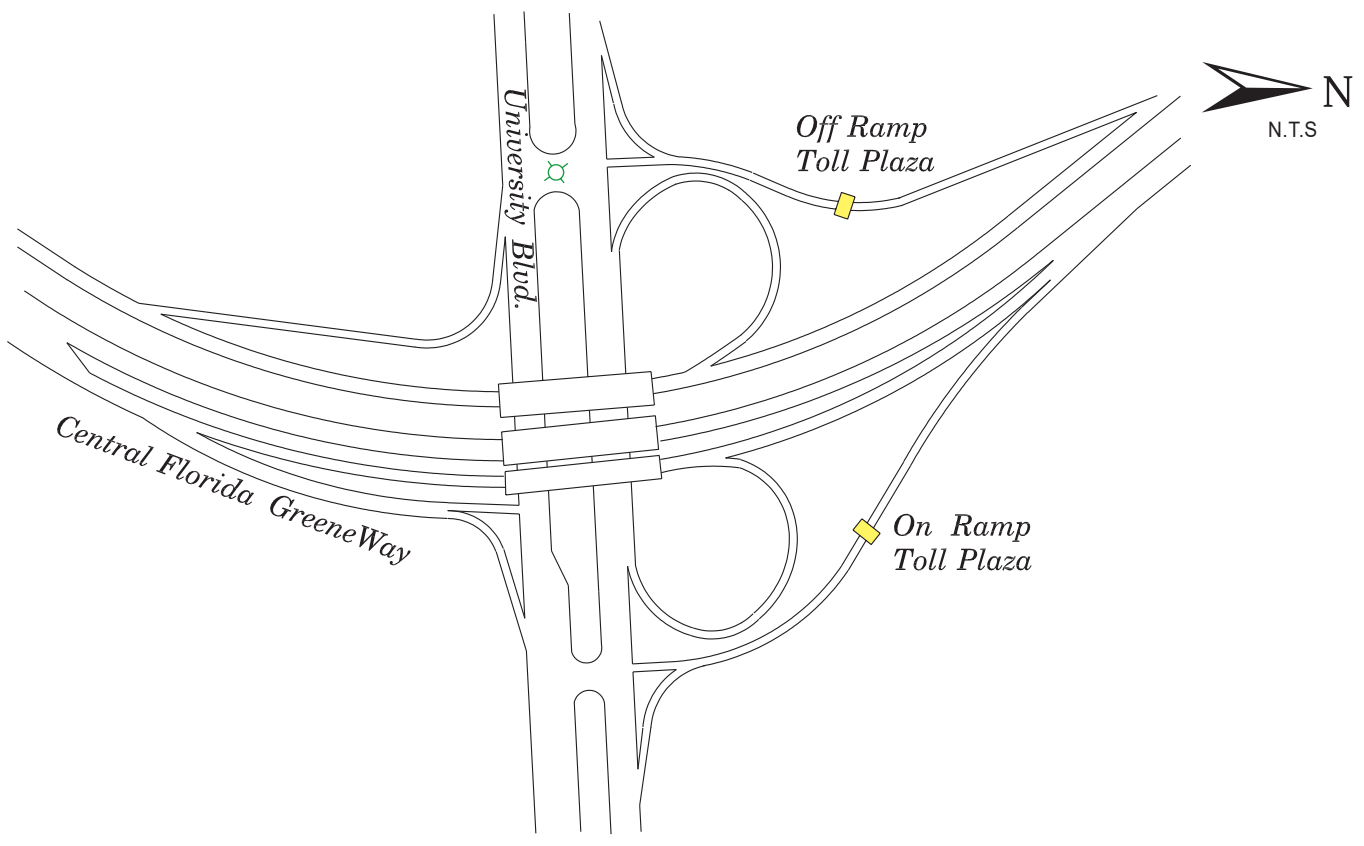

ORG-ID: 3  
 FACILITY: SR 417 - UNIVERSITY

\* Changeable Message Sign

Note: All Changeable Message Signs (CMS) can display three messages: EXACT COINS, CHANGE RECEIPTS, E-PASS ONLY

# Western Beltway



## Mainline Toll Plazas and Associated Ramps

LEGEND

*For Lane Designations for all Plazas*

*CA - Exact Coin with E-PASS*

*MA - Change Receipts (Staffed) with E-PASS*

*MCA - Booth with Manual Lane Terminal,  
Automatic Coin Machine and E-PASS*



↑ To SR 50 & Florida's Turnpike

Next Interchange: West Rd.  
 Next Mainline Plaza: Independence Mainline  
 Next Ramp Plaza: West Rd.  
 NB-OFF/SB-ON

↓ To US 441, Apopka

Next Interchange: CR 437A  
 Next Mainline Plaza: SR 429 - Ponkan Mainline  
 Next Ramp Plaza: None

Admin.  
Bldg.

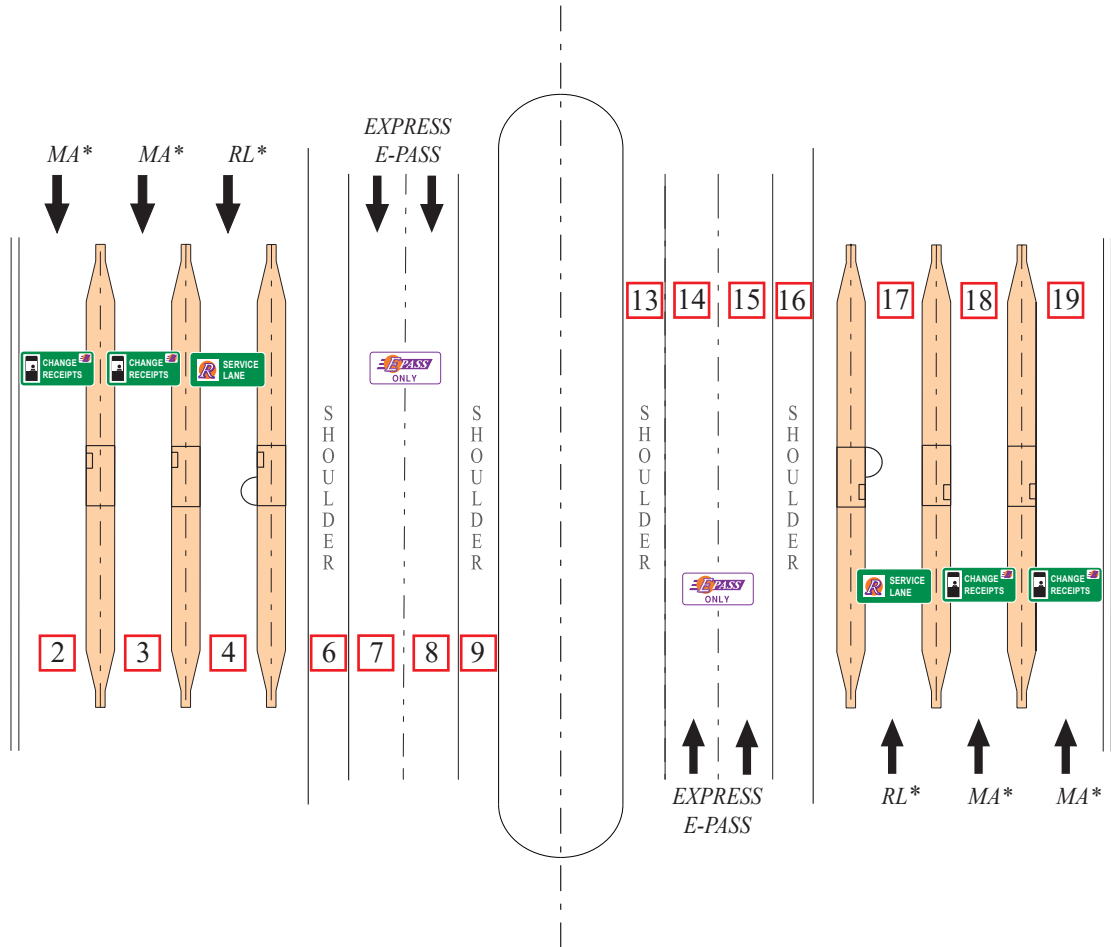

Note: All Changeable Message Signs (CMS) can display three messages: EXACT COINS, CHANGE RECEIPTS, E-PASS ONLY

ORG-ID: 10	PID: 367
FACILITY: SR 429 - FOREST LAKE	

LANES OF EQUIPMENT

- 4 Staffed Booth with E-PASS (MA)
- 2 E-PASS Reload Lane (RL)
- 4 Express E-PASS (E-PASS only)
- \* Changeable Message Sign

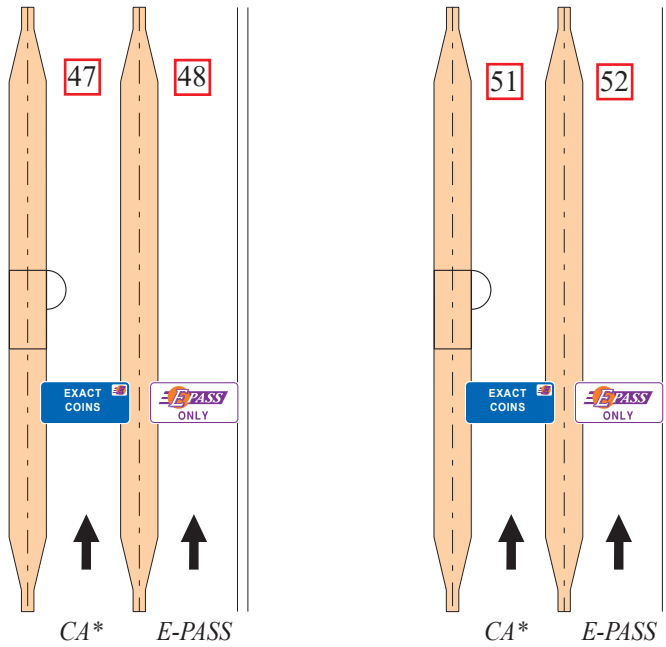
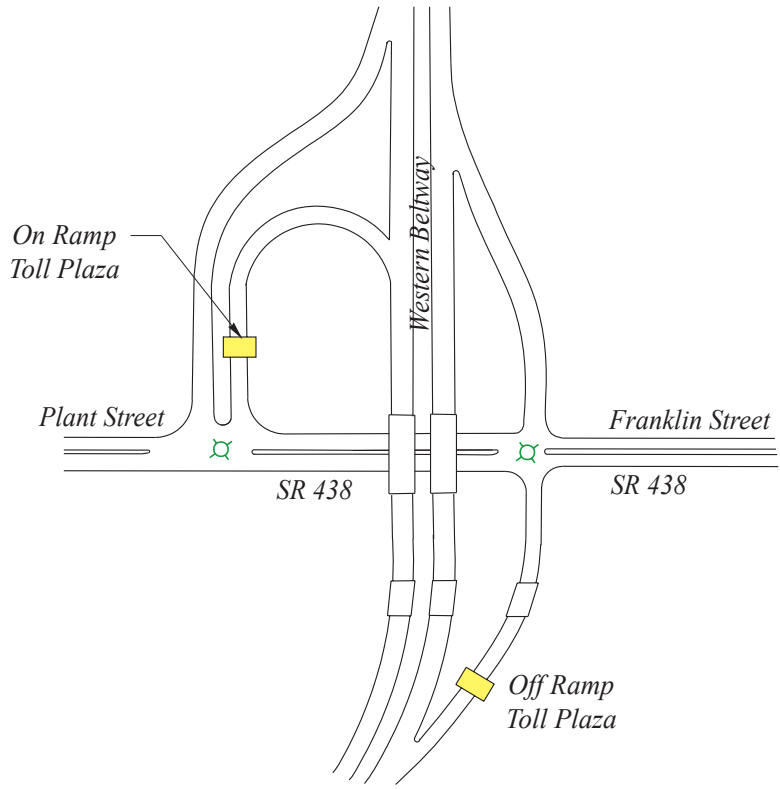

ORG-ID: 10  
 FACILITY: SR 429 - FOREST LAKE

\* Changeable Message Sign

SR 438  
 ON RAMP  
 R05  
 PID: 370

SR 438  
 OFF RAMP  
 R06  
 PID: 371

Note: All Changeable Message Signs (CMS) can display three messages: EXACT COINS, CHANGE RECEIPTS, E-PASS ONLY

Reports to Forest Lake Mainline Toll Plaza

T:\OCEA\OCEA MANUAL\STol Facilities Reference Book\2016 Tolls Manual - 3/10/16-CP

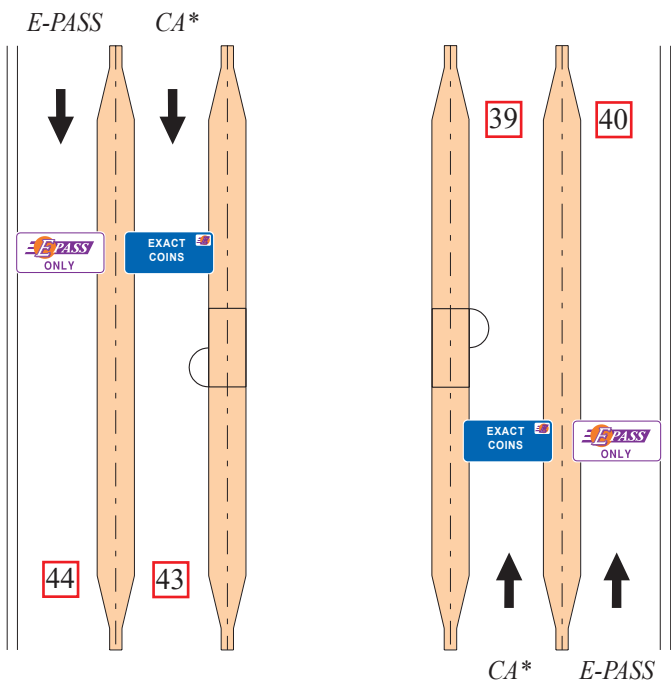
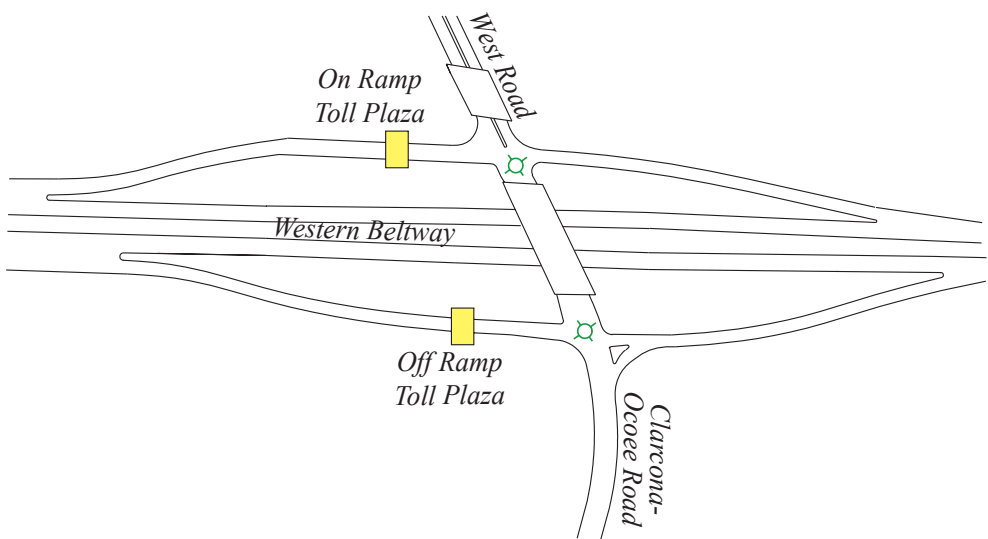

ORG-ID: 10  
 FACILITY: SR 429 - FOREST LAKE

\* Changeable Message Sign

WEST RD.  
 OFF RAMP  
 R04  
 PID: 369

WEST RD.  
 ON RAMP  
 R03  
 PID: 368

Note: All Changeable Message Signs (CMS) can display three messages: EXACT COINS, CHANGE RECEIPTS, E-PASS ONLY

Reports to Forest Lake Mainline Toll Plaza

T:\OCEA\OCEA MANUAL\STol Facilities Reference Book\2016 Tolls Manual - 3/10/16-CP

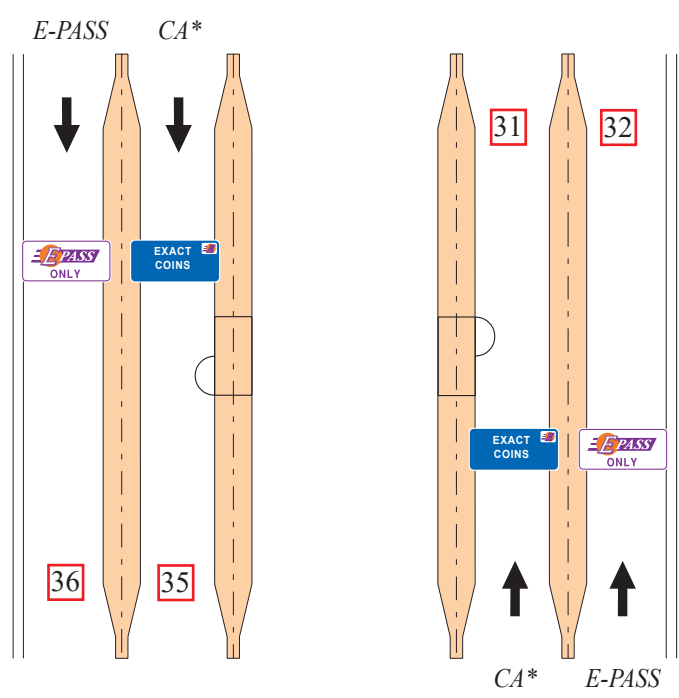
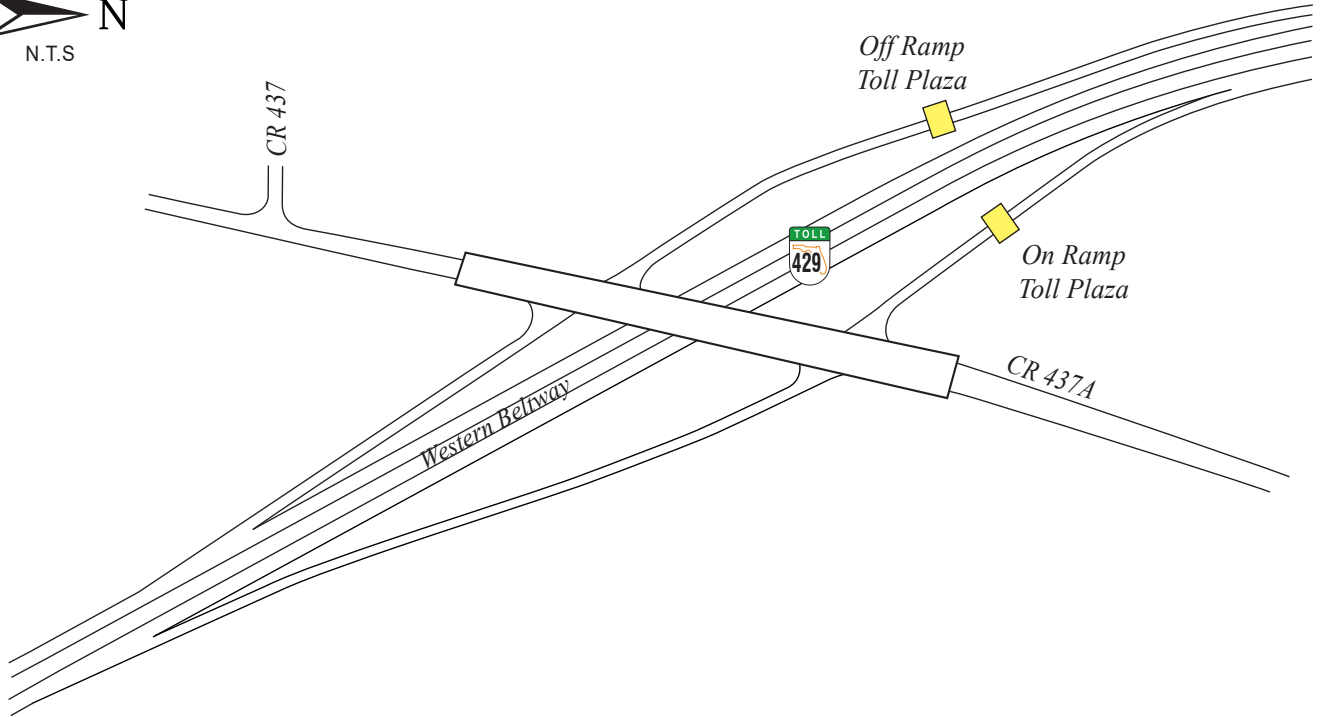

ORG-ID: 10  
 FACILITY: SR 429 - FOREST LAKE

\* Changeable Message Sign

CR 437A  
 OFF RAMP  
 R02  
 PID: 418

CR 437A  
 ON RAMP  
 R01  
 PID: 417

Reports to Forest Lake Mainline Toll Plaza

Note: All Changeable Message Signs (CMS) can display three messages: EXACT COINS, CHANGE RECEIPTS, E-PASS ONLY

T:\OCEA\OCEA MANUAL\STol Facilities Reference Book\2016 Tolls Manual - 3/10/16-CP

↑ To Florida's Turnpike, S.R. 50 & Apopka (US 441)  
 ↓ To New Independence Parkway, U.S. 192 & I-4

Next Interchange: C.R. 535  
 Next Mainline Plaza: Forest Lake Mainline  
 Next Ramp Plaza: C.R. 535  
 NB-ON / SB-OFF

Admin. Bldg.

Next Interchange: New Independence Pkwy.  
 Next Mainline Plaza: SR 429 Daniel Webster Western Beltway  
 Next Ramp Plaza: New Independence Pkwy.  
 SB-ON / NB-OFF

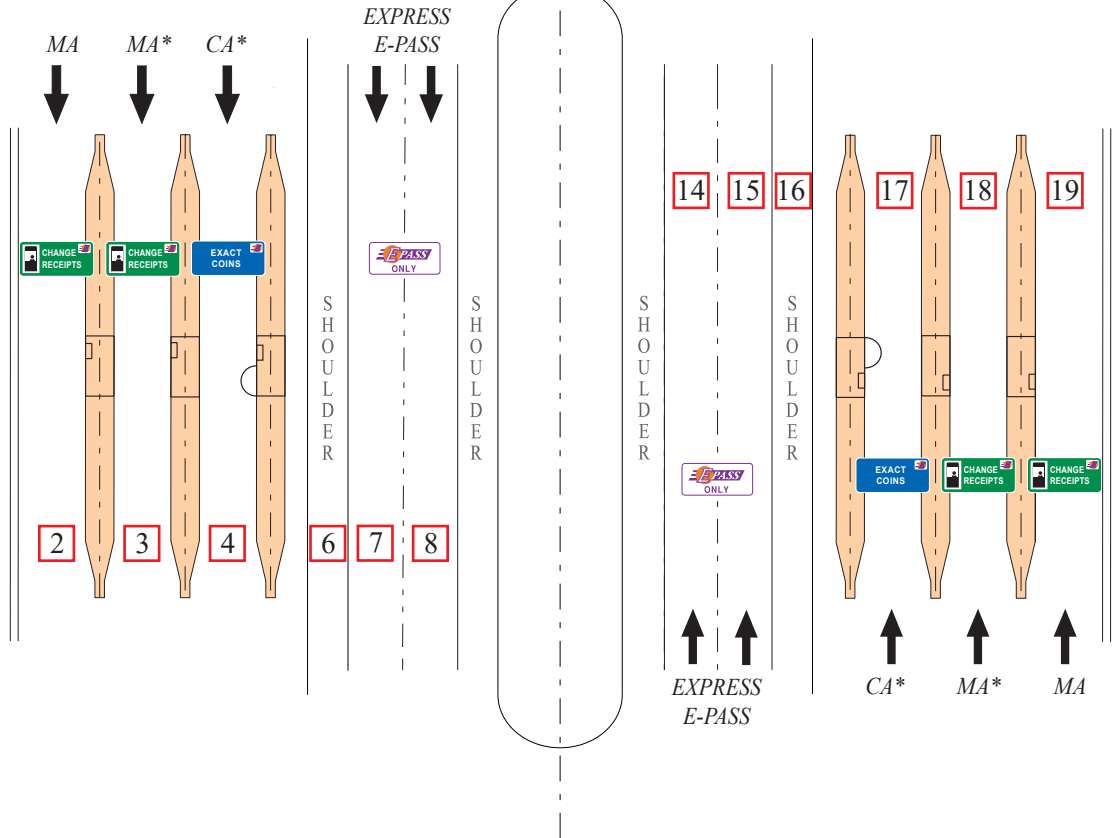

Note: All Changeable Message Signs (CMS) can display three messages: EXACT COINS, CHANGE RECEIPTS, E-PASS ONLY

ORG-ID: 11 PID: 375  
 FACILITY: SR 429 - INDEPENDENCE

- LANES OF EQUIPMENT
- 4 Staffed Booths with E-PASS (MA)
  - 2 Booths with ACM and E-PASS
  - 4 Express E-PASS (E-PASS only)
  - \* Changeable Message Sign

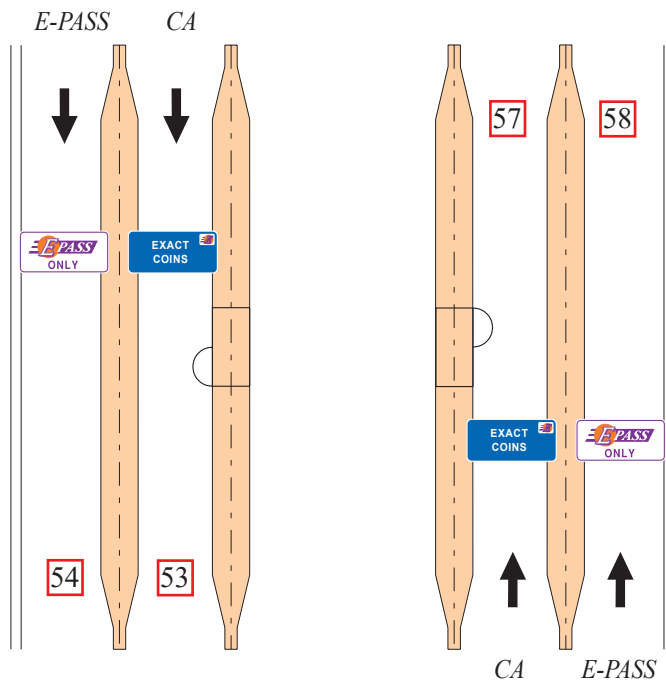
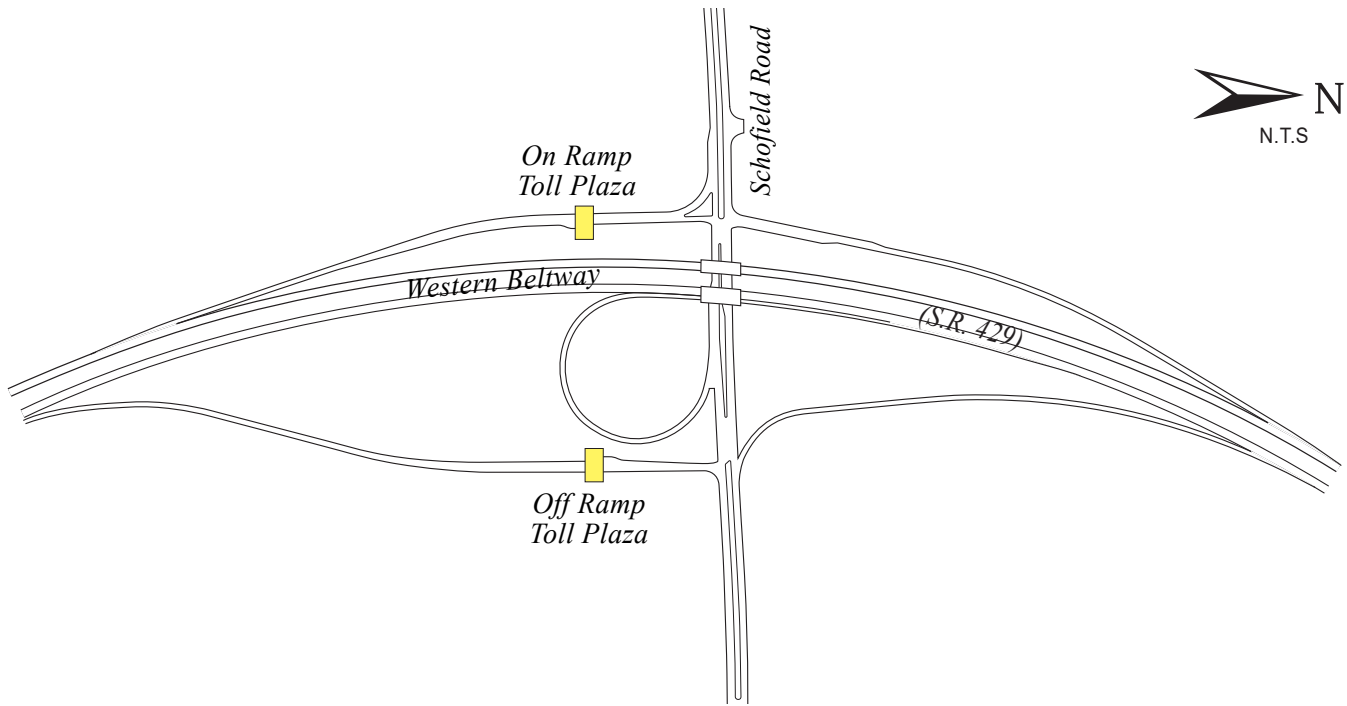

ORG-ID: 11  
 FACILITY: SR 429 - INDEPENDENCE

SCHOFIELD  
 ON RAMP  
 R05  
 PID: 419

SCHOFIELD  
 OFF RAMP  
 R06  
 PID: 420

Reports to Independence Mainline Toll Plaza

T:\OCEA\OCEA MANUAL\STol Facilities Reference Book\2016 Tolls Manual - 3/10/16-CP

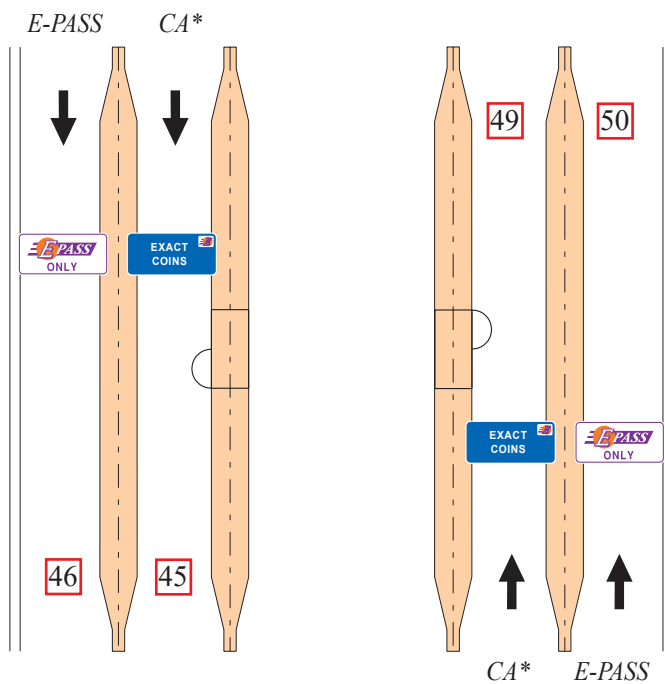
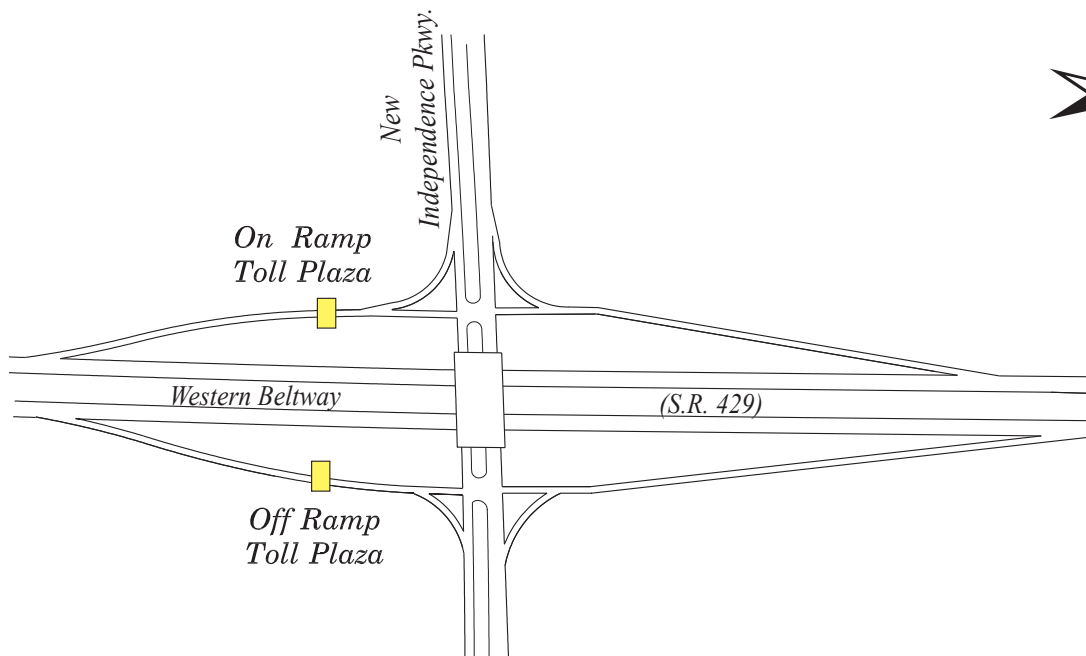

ORG-ID: 11  
 FACILITY: SR 429 - INDEPENDENCE

\* Changeable Message Sign

Note: All Changeable Message Signs (CMS) can display three messages: EXACT COINS, CHANGE RECEIPTS, E-PASS ONLY

Reports to Independence Mainline Toll Plaza

T:\OCEA\OCEA MANUAL\STol Facilities Reference Book\2016 Tolls Manual - 3/10/16-CP

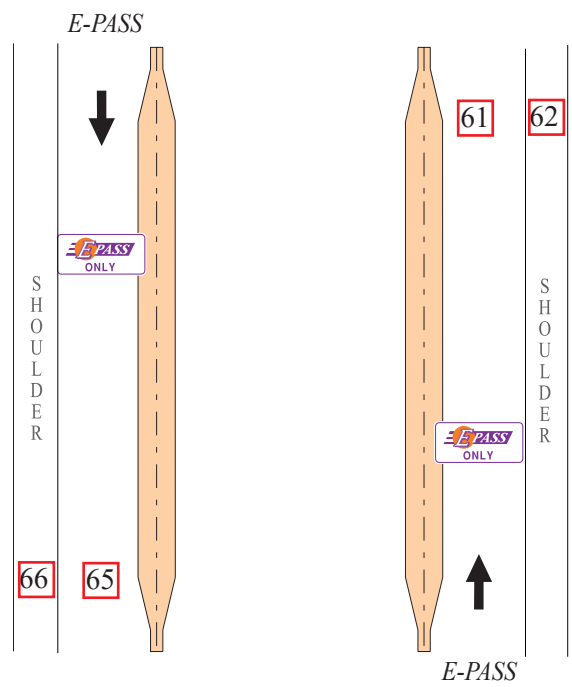
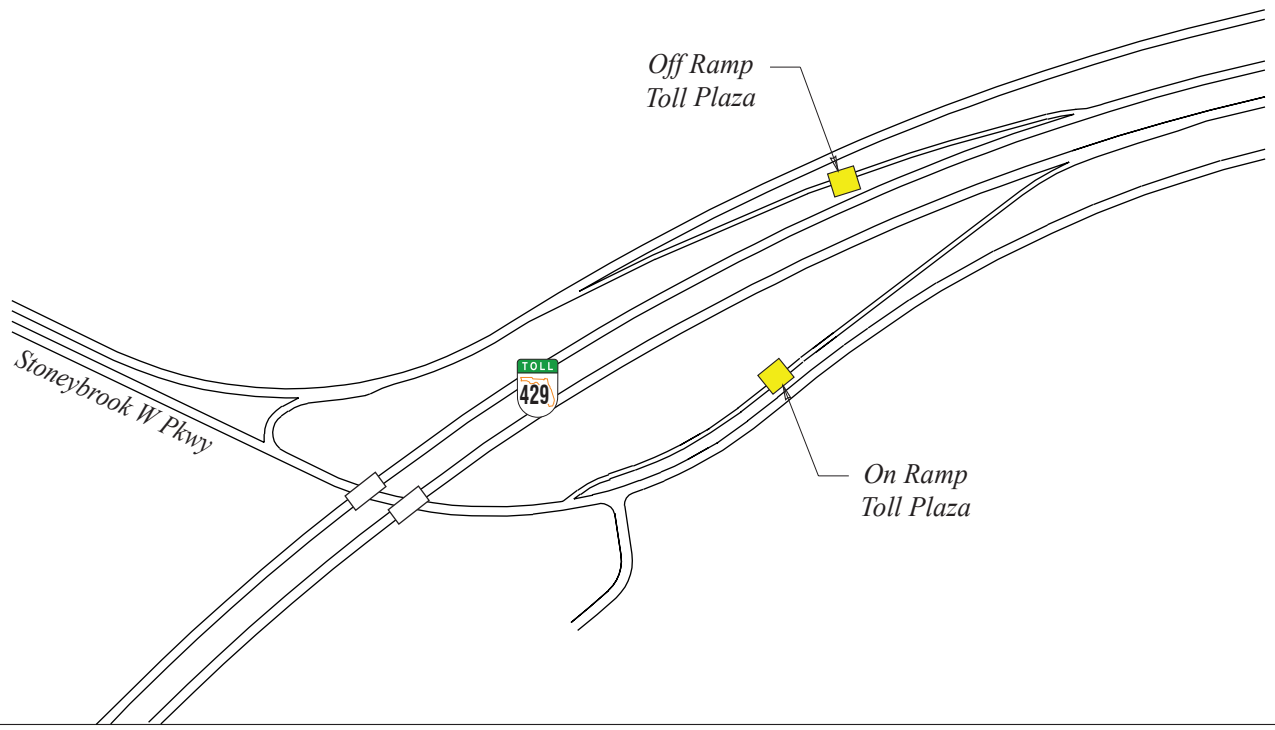

ORG-ID: 11  
FACILITY: SR 429 - INDEPENDENCE

STONEBROOK W PKWY  
OFF RAMP  
R08  
PID: 439

STONEBROOK W PKWY  
ON RAMP  
R07  
PID: 438

Reports to Independence Mainline Toll Plaza

T:\OCEA\OCEA MANUAL\STol Facilities Reference Book\2016 Tolls Manual - 3/10/16-CP



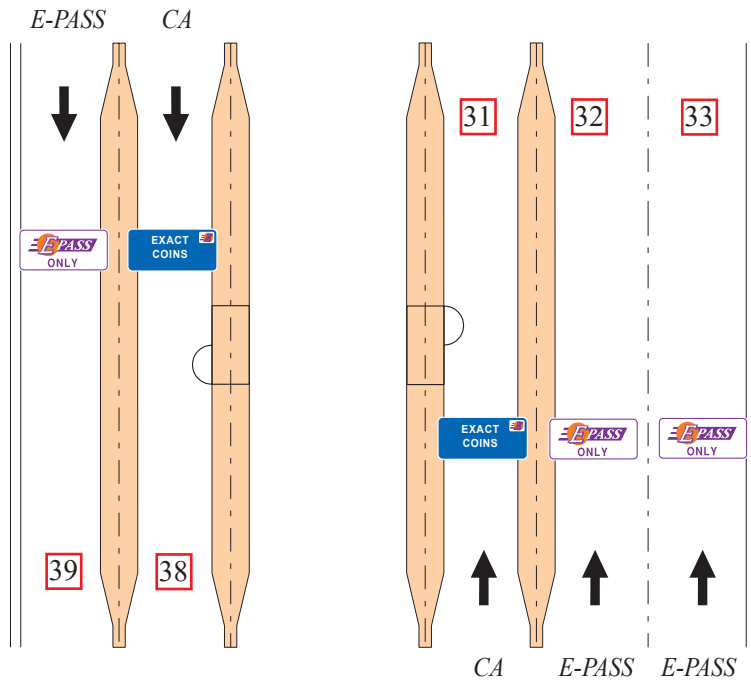
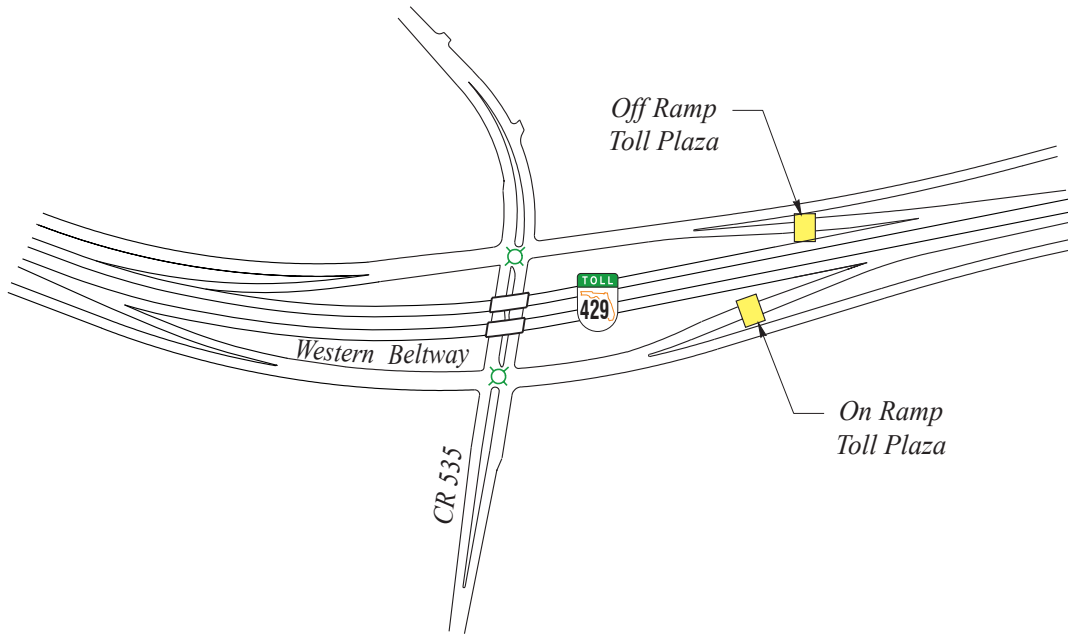

ORG-ID: 11  
 FACILITY: SR 429 - INDEPENDENCE

CR 535  
 OFF RAMP  
 R02  
 PID: 377

CR 535  
 ON RAMP  
 R01  
 PID: 376

Reports to Independence Mainline Toll Plaza

T:\DOCEA\DOCEA MANUAL\STol Facilities Reference Book\2016 Tolls Manual - 3/10/16-CP

↑  
To Kelly Park Rd., SR 453  
, Mount Dora & Leesburg  
Next Interchange: West Kelly Park Road  
Next Mainline Plaza: Mt. Plymouth Mainline  
Next Ramp Plaza: None

↓  
To SR 429 (Connector Rd.)  
SR 441 (Orange Blossom Tr.),  
Next Interchange: US 441  
Next Mainline Plaza: Forest Lake Mainline  
Next Ramp Plaza: None

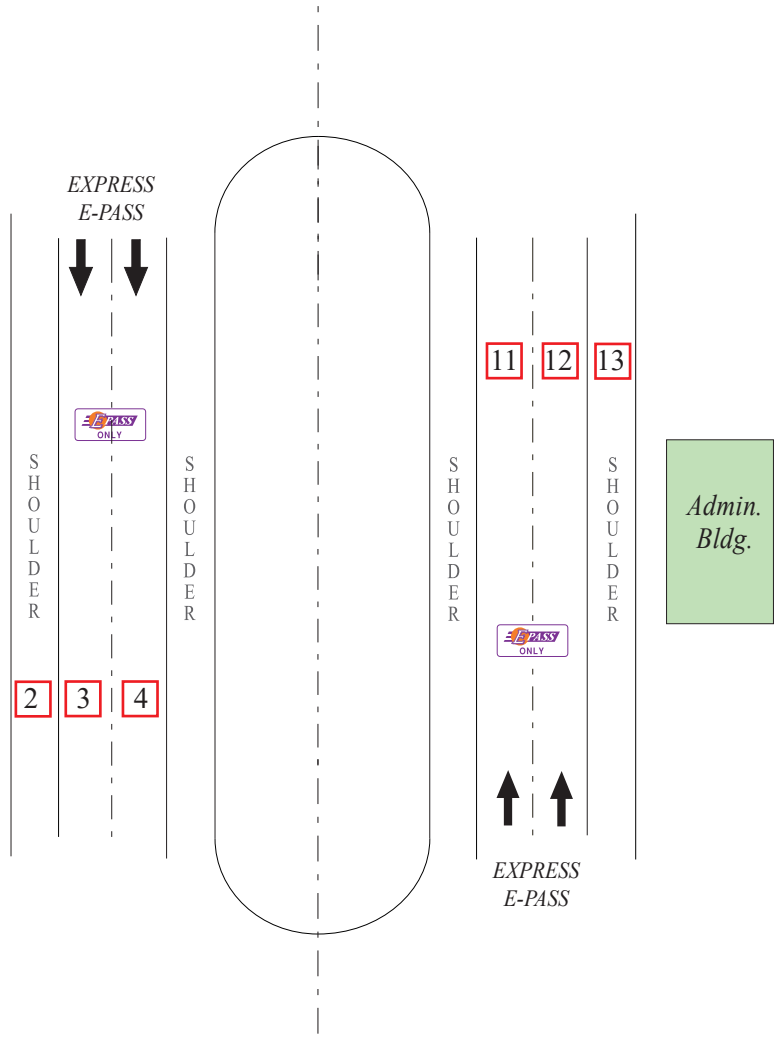

ORG-ID: 16	PID: 433
FACILITY: SR 429 - PONKAN	

LANES OF EQUIPMENT  
4 Express E-PASS (E-PASS only)



To SR 453 , South SR 429  
Mount Dora & Leasburg

Next Interchange: SR 453  
Next Mainline Plaza: Coronado SB Mainline Toll Gantry/  
Ponkan Mainline

To SR 46

Next Interchange: SR 46  
Next Mainline Plaza: Mt. Plymouth

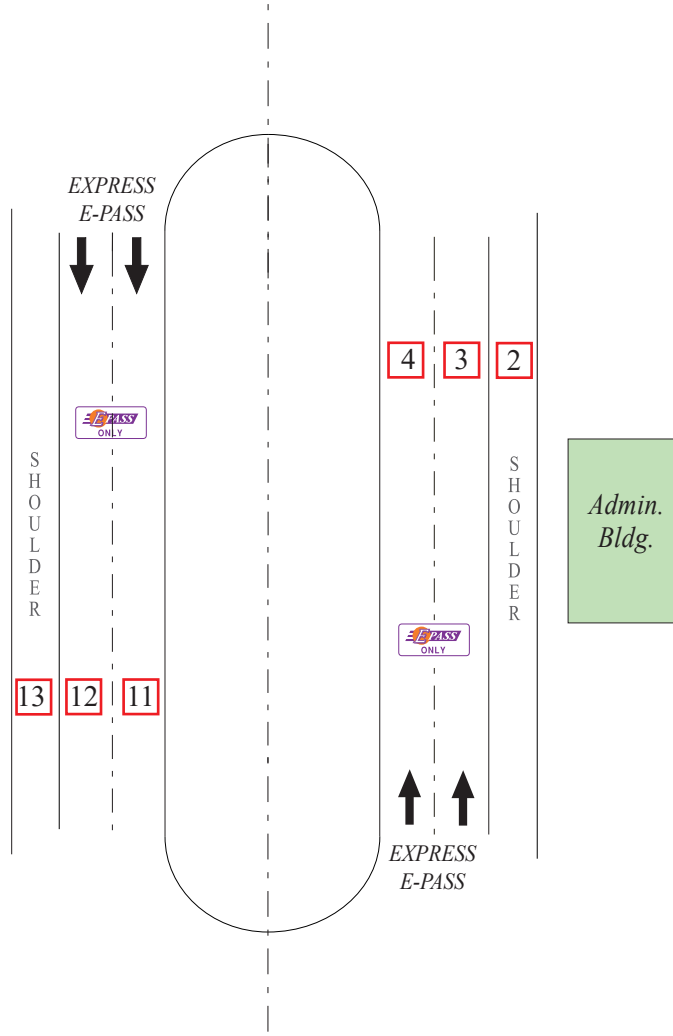

ORG-ID: 21	PID: 434
FACILITY: SR 429 - Mt. PLYMOUTH	

LANES OF EQUIPMENT  
4 Express E-PASS (E-PASS only)

# Mount-Dora Connector



# Mainline Toll Plaza

*LEGEND*

*For Lane Designations for all Plazas*

*AET - Express Lanes*

To SR 46  
Next Interchange: SR 46

To SR 429 & SR 453  
Next Interchange: SR 429  
Next Mainline Plaza: Ponkan Mainline  
Mt. Plymouth Mainline

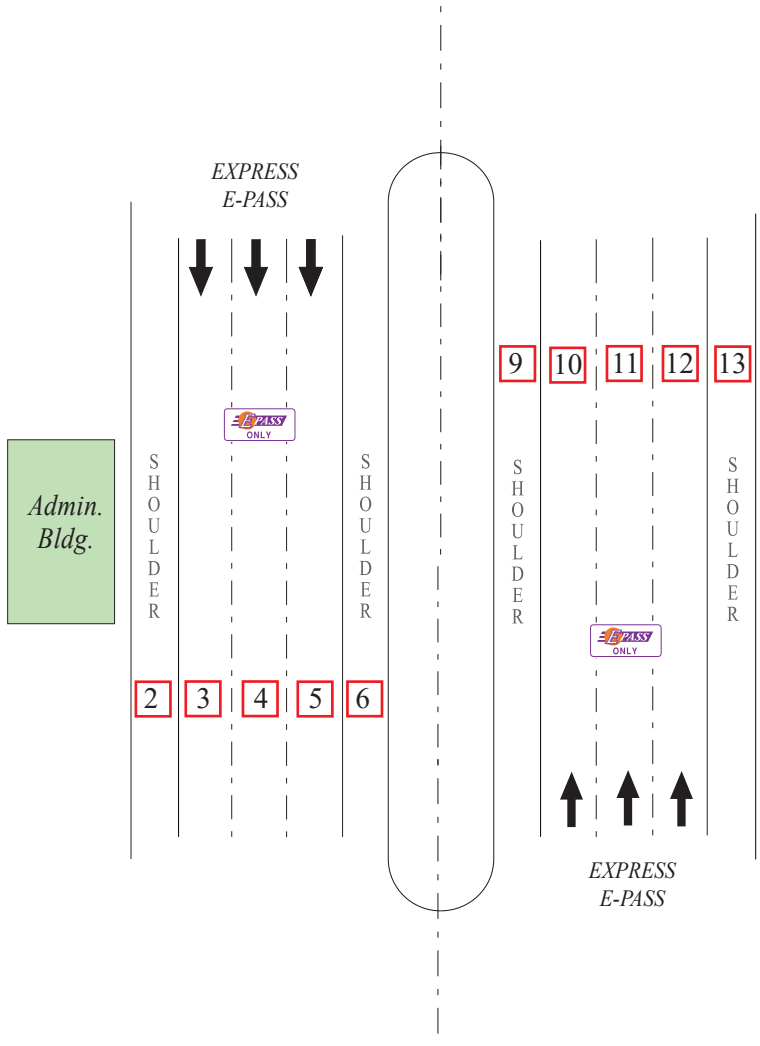

ORG-ID: 22	PID: 435
FACILITY: SR 453 - CORONADO	

LANES OF EQUIPMENT  
6 Express E-PASS (E-PASS only)

# Beachline Expressway



## Mainline Toll Plazas and Associated Ramps

LEGEND

*For Lane Designations for all Plazas*

*CA - Exact Coin with E-PASS*

*MA - Change Receipts (Staffed) with E-PASS*

*MCA - Booth with Manual Lane Terminal,  
Automatic Coin Machine and E-PASS*

↑  
To SR 520, I-95 &  
Port Canaveral

Next Interchange: SR 520  
Next Mainline Plaza: None  
Next Ramp Plaza: SR 520 Eastbound  
EB-ON/WB-OFF



Admin.  
Blg.

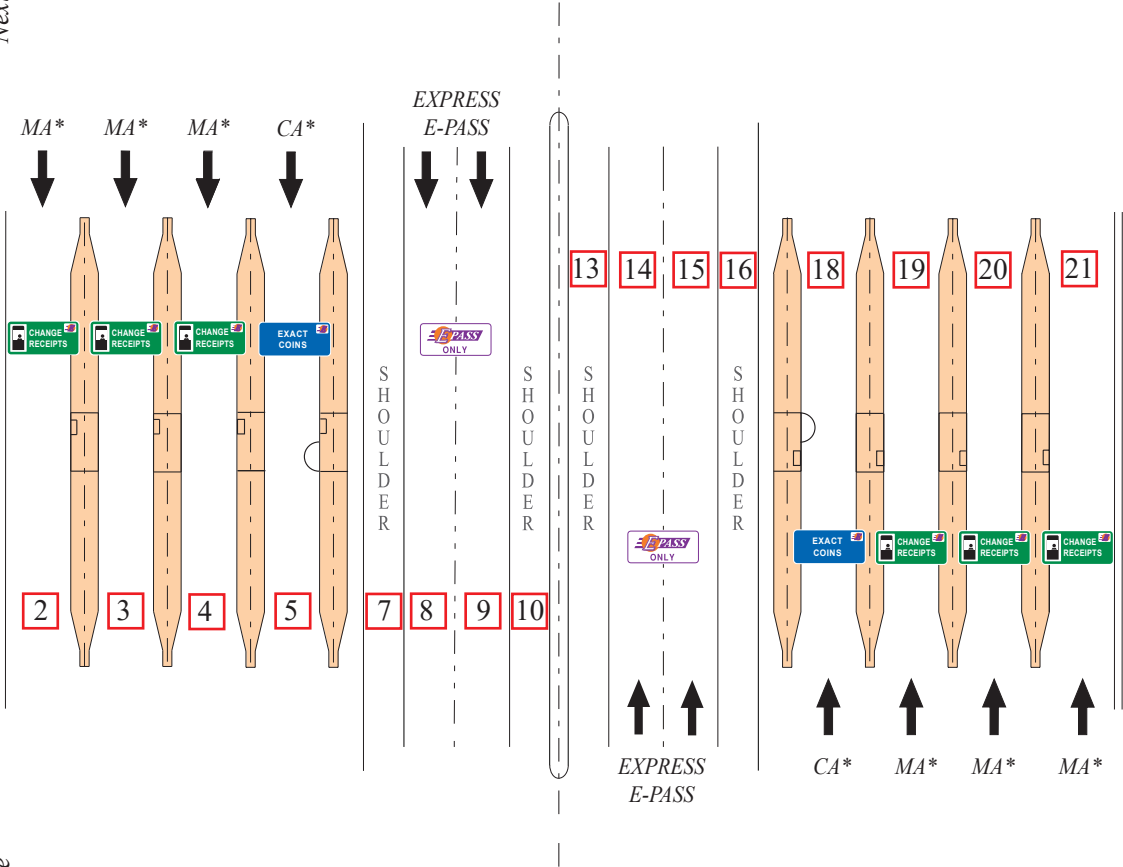

↓  
To SR 417 (Greene Way),  
SR 436 (Semoran Blvd)  
& Orlando Int'l Airport

Next Interchange: Innovation Way.  
Next Mainline Plaza: Beachline Mainline  
Next Ramp Plaza: Innovation Way

Note: All Changeable Message Signs (CMS) can display three messages: EXACT COINS, CHANGE RECEIPTS, E-PASS ONLY

ORG-ID: 19	PID: 414
FACILITY: SR 528 - DALLAS	

- LANES OF EQUIPMENT
- 6 Staffed Booths with E-PASS (MA)
  - 2 Booths with ACM's and E-PASS
  - 4 Express E-PASS (E-PASS only)
  - \* Changeable Message Sign

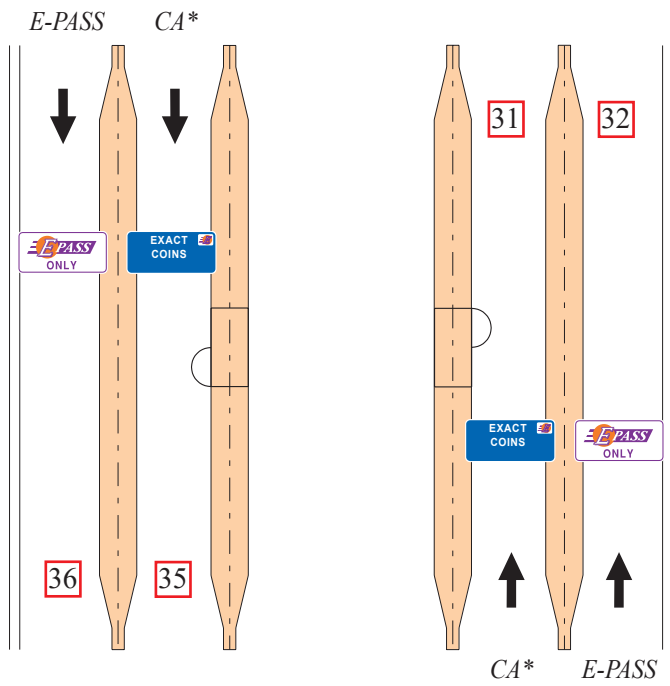
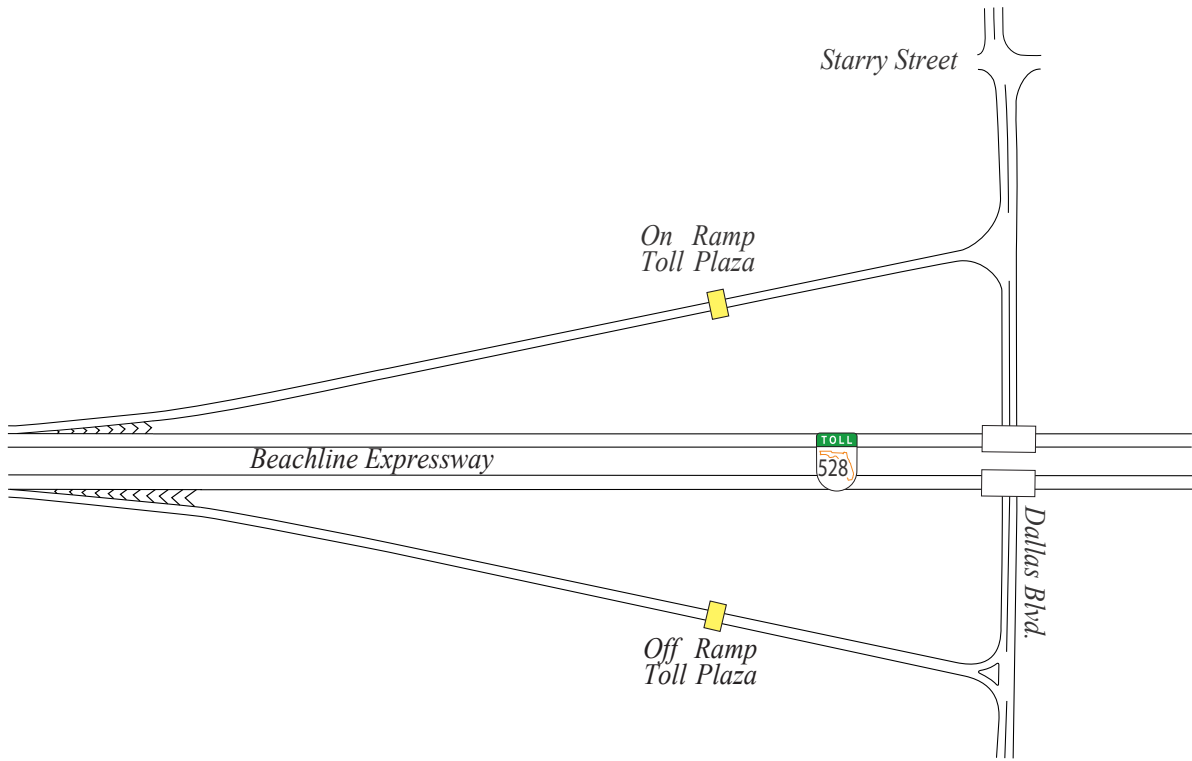

DALLAS  
OFF RAMP  
R02  
PID: 416

DALLAS  
ON RAMP  
R01  
PID: 415

ORG-ID: 19
FACILITY: SR 528 - DALLAS

\* Changeable Message Sign

Note: All Changeable Message Signs (CMS) can display three messages: EXACT COINS, CHANGE RECEIPTS, E-PASS ONLY

Reports to Dallas Blvd. Mainline Toll Plaza

T:\OCEA\OCEA MANUAL\STol Facilities Reference Book\2016 Tolls Manual - 3/10/16-CP



↑  
**To SR 520, I-95 & Port Canaveral**  
 Next Interchange: Innovation Way  
 Next Mainline Plaza: Dallas  
 Next Ramp Plaza: Innovation Way  
 EB-ON/WB-OFF

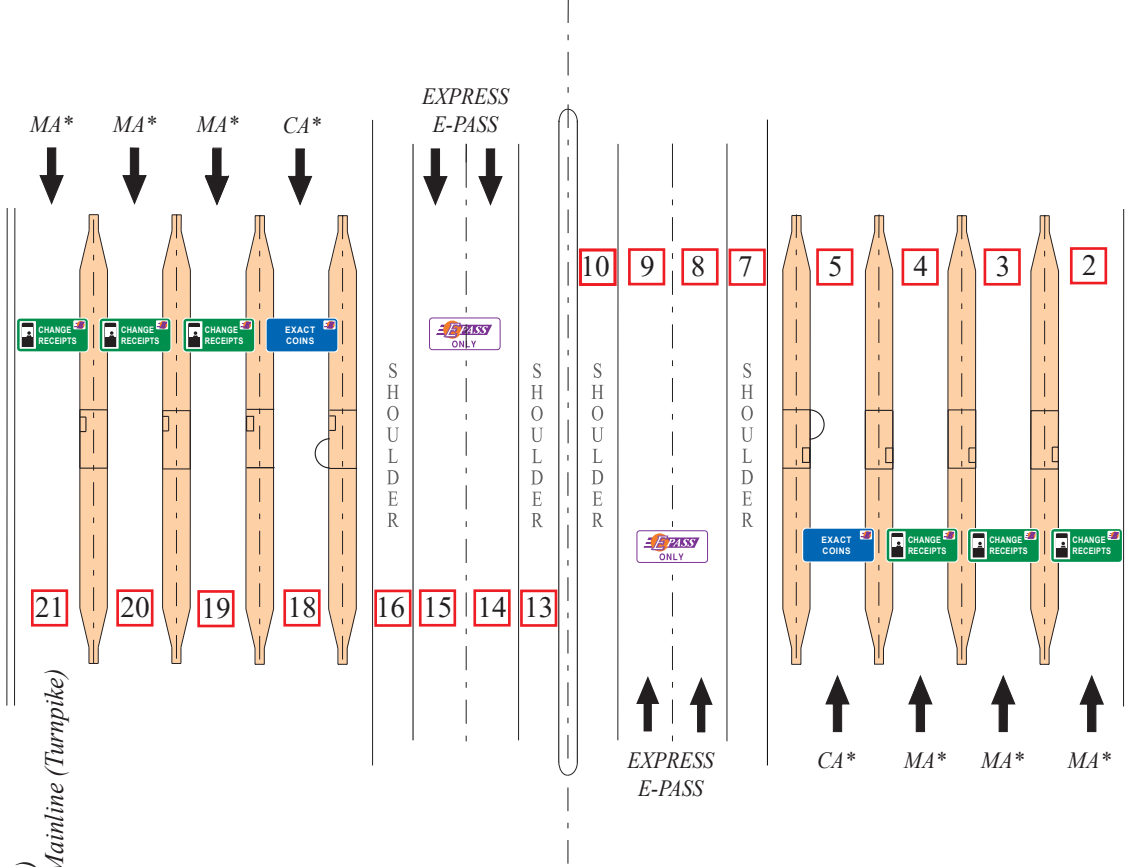

↓  
**To SR 417 (Greene Way), SR 436 (Semoran Blvd) & Orlando Int'l Airport**  
 Next Interchange: SR 417 (Greene Way)  
 Next Mainline Plaza: Beachline West Mainline (Turnpike)  
 Next Ramp Plaza: Goldenrod Rd.

Note: All Changeable Message Signs (CMS) can display three messages: EXACT COINS, CHANGE RECEIPTS, E-PASS ONLY

ORG-ID: 9	PID: 344
FACILITY: SR 528 - BEACHLINE	

- LANES OF EQUIPMENT
- 6 Staffed Booths with E-PASS (MA)
  - 2 Booths with ACM's and E-PASS
  - 4 Express E-PASS (E-PASS only)
  - \* Changeable Message Sign

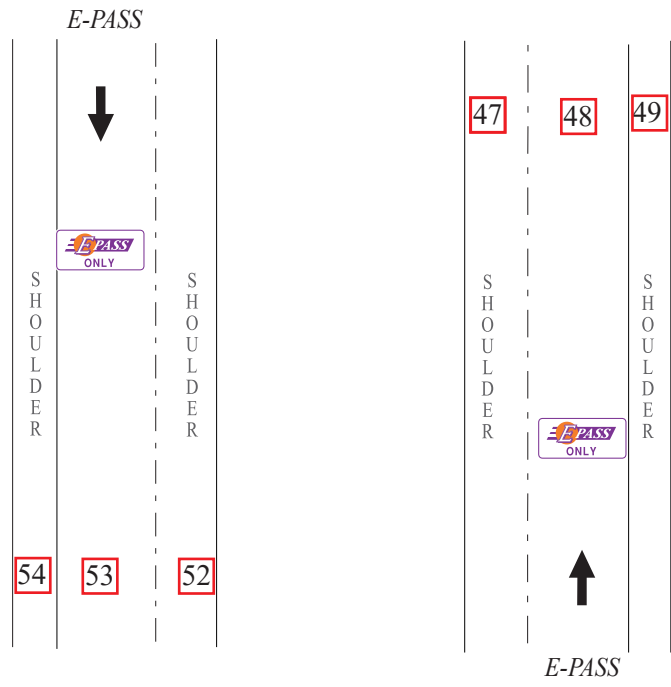
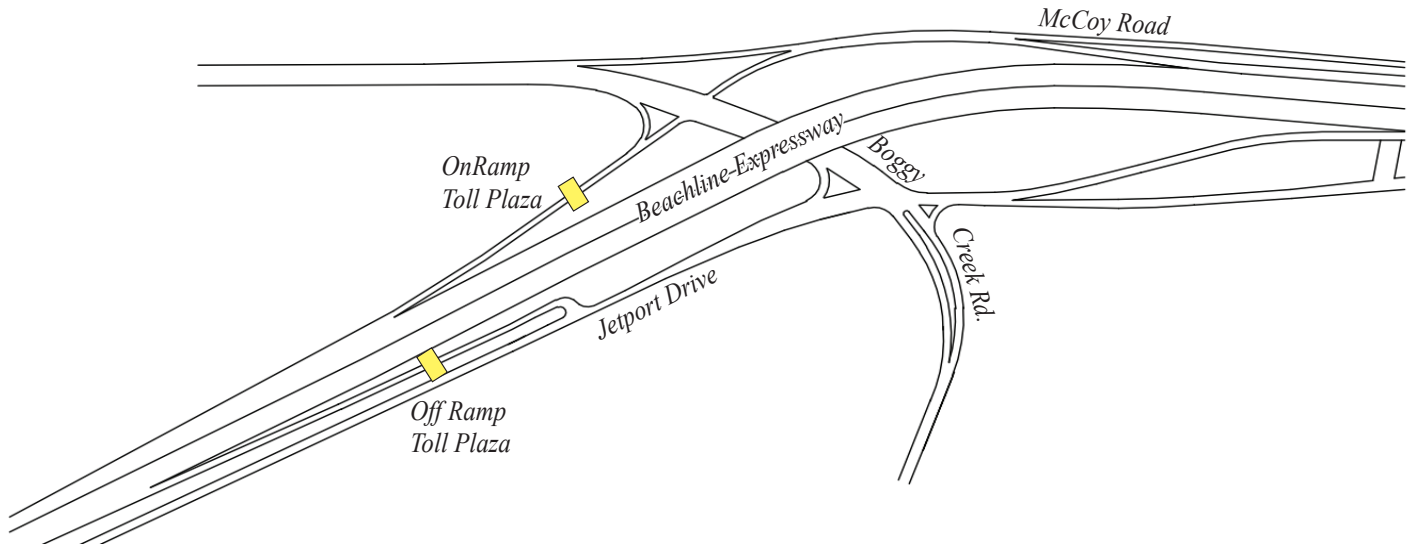

ORG-ID: 9  
 FACILITY: SR 528 - BEACHLINE

**JETPORT REBATE**  
**OFF RAMP**  
 R06  
 PID: 428

**MCCOY REBATE**  
**ON RAMP**  
 R05  
 PID: 427

Reports to Beachline Mainline Toll Plaza

*Note: These lanes are Rebate Ramps and will be cross-referenced to determine if a rebate is provided*

T:\OCEA\OCEA MANUAL\STol Facilities Reference Book\2016 Tolls Manual - 3/10/16-CP

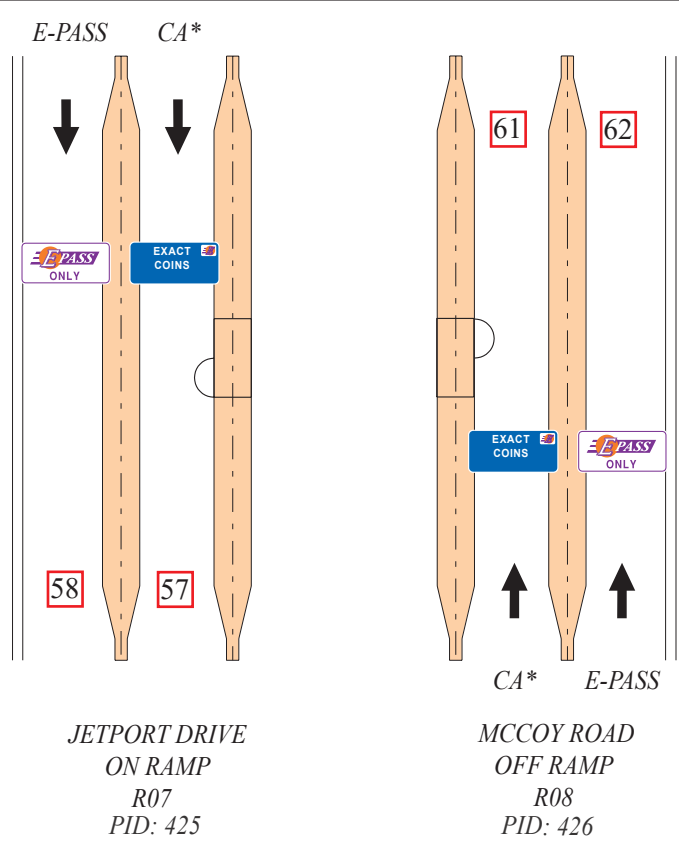
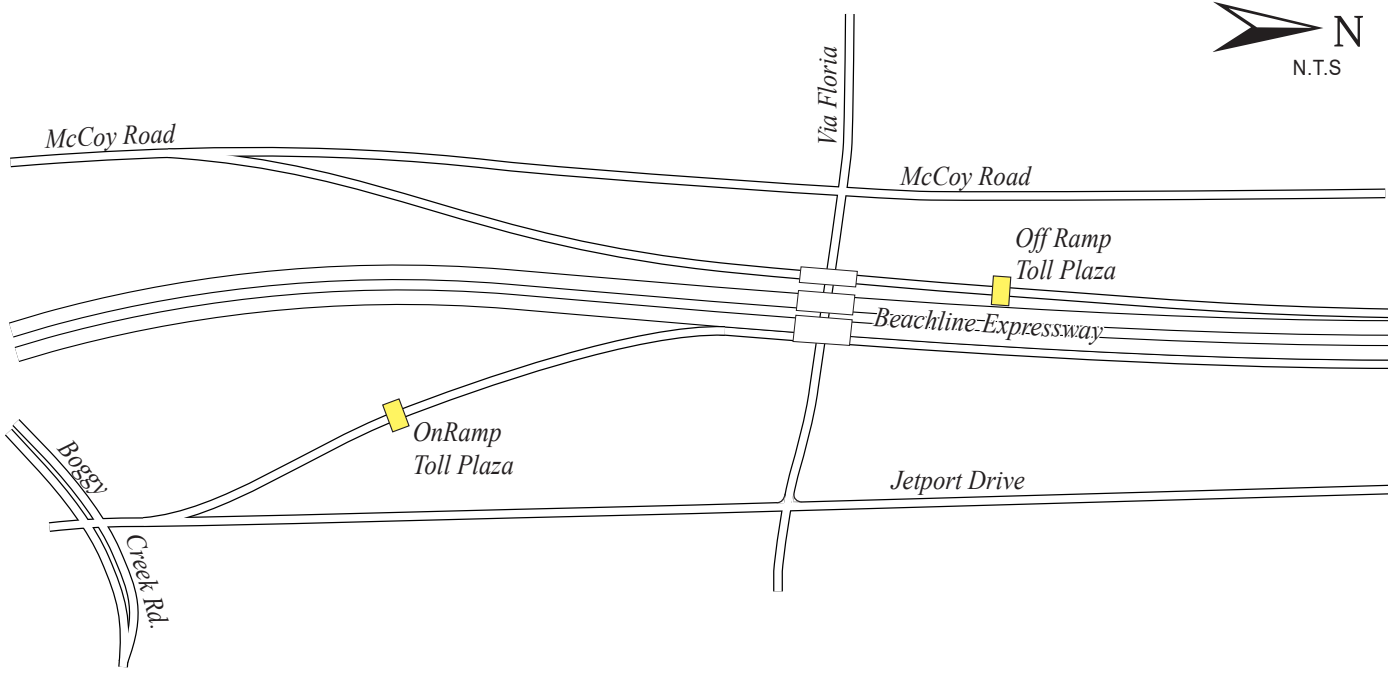

ORG-ID: 9  
 FACILITY: SR 528 - BEACHLINE

\* Changeable Message Sign

Note: All Changeable Message Signs (CMS) can display three messages: EXACT COINS, CHANGE RECEIPTS, E-PASS ONLY

Reports to Beachline Mainline Toll Plaza

T:\OCEA\OCEA MANUAL\STol Facilities Reference Book\2016 Tolls Manual - 3/10/16-CP

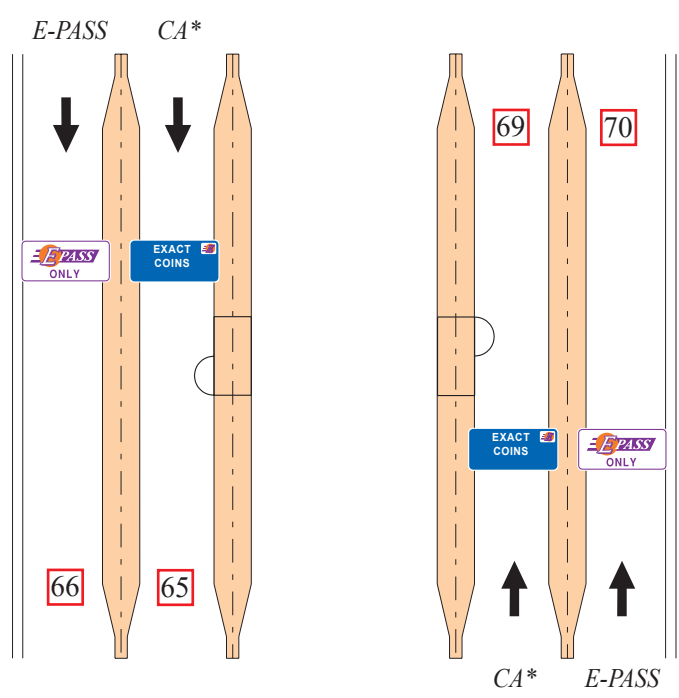
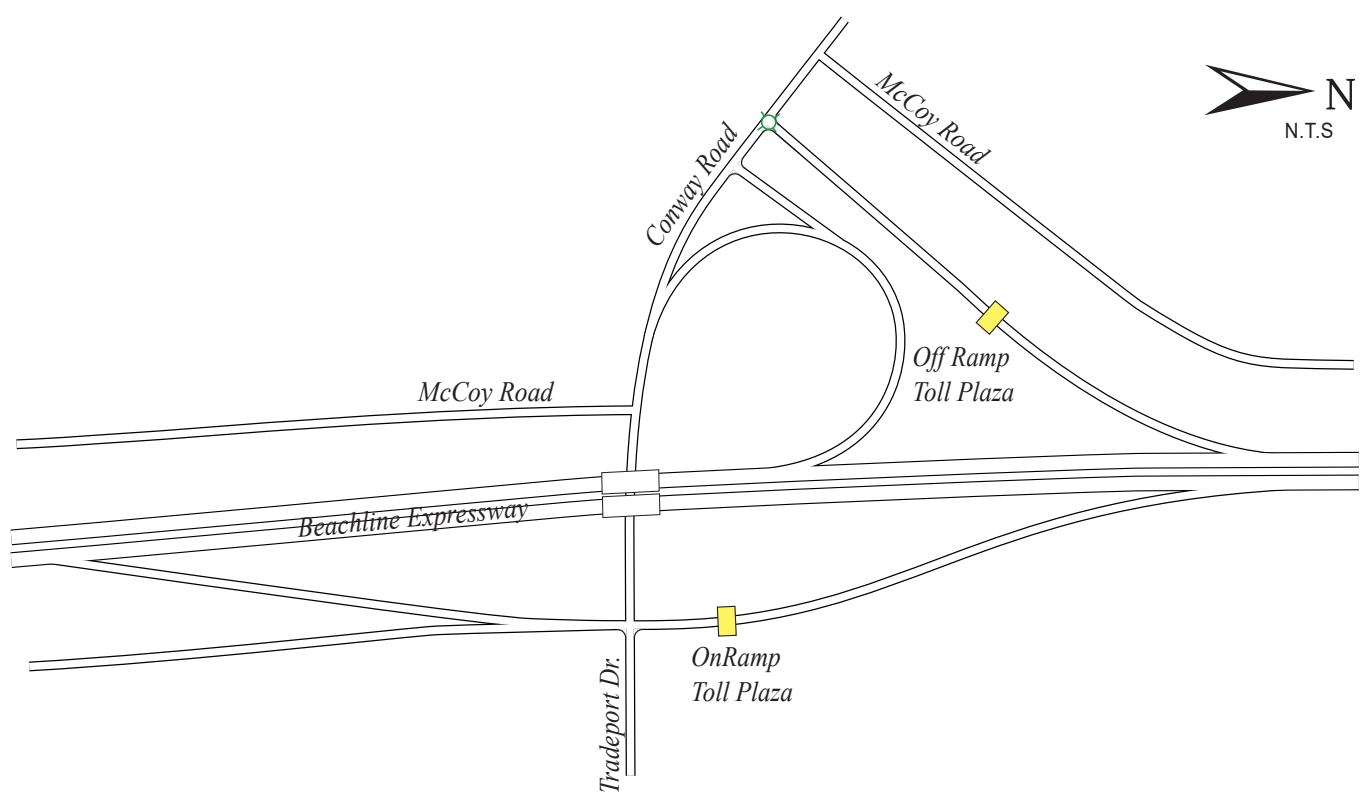

ORG-ID: 9  
 FACILITY: SR 528 - BEACHLINE

\* Changeable Message Sign

Note: All Changeable Message Signs (CMS) can display three messages: EXACT COINS, CHANGE RECEIPTS, E-PASS ONLY

TRADEPORT  
 ON RAMP  
 R09  
 PID: 423

CONWAY  
 OFF RAMP  
 R10  
 PID: 424

Reports to Beachline Mainline Toll Plaza

T:\OCEA\OCEA MANUAL\STol Facilities Reference Book\2016 Tolls Manual - 3/10/16-CP

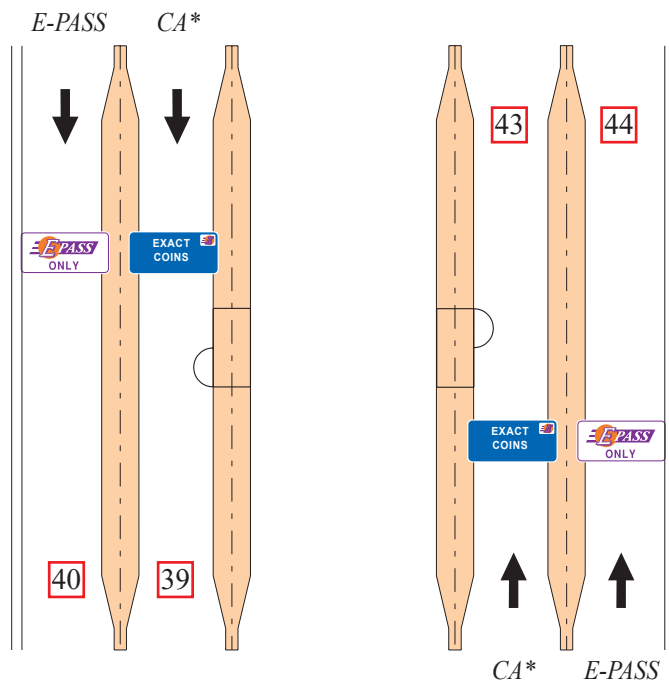
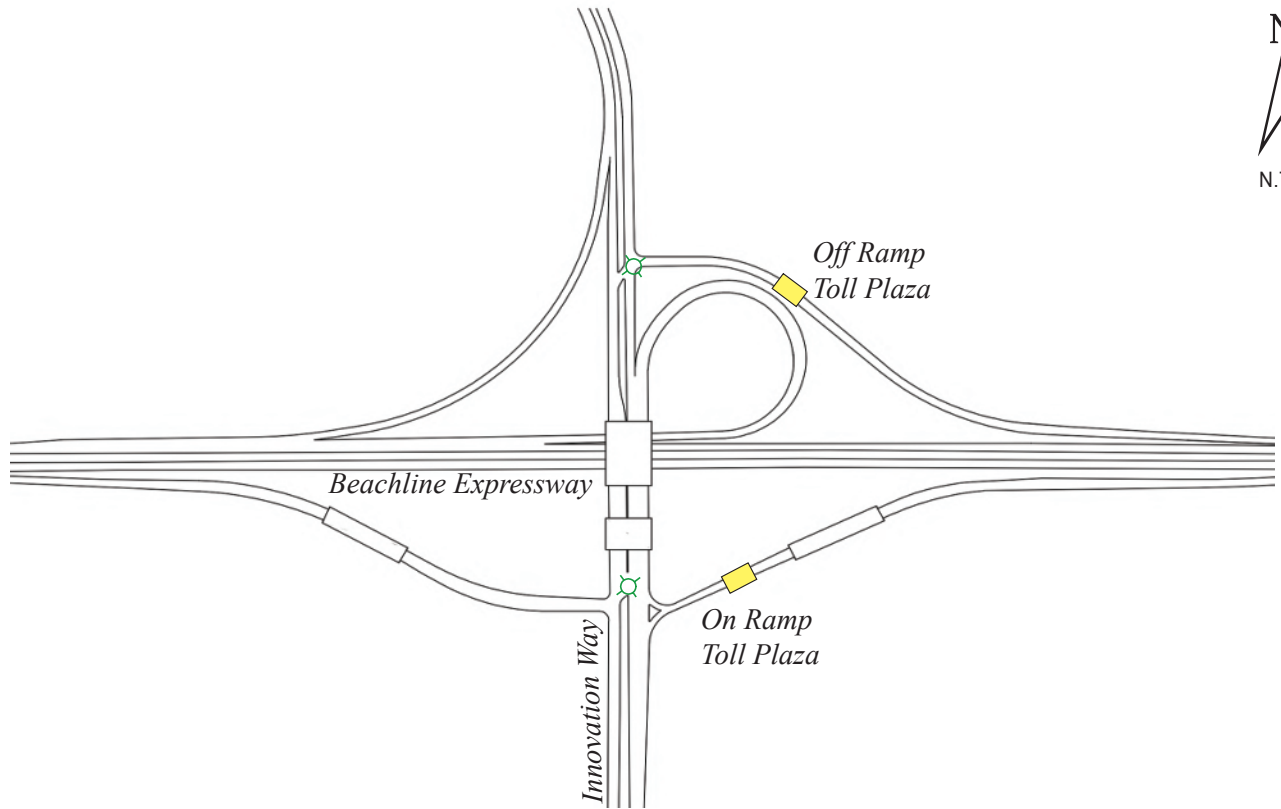

ORG-ID: 9  
 FACILITY: SR 528 - BEACHLINE

\* Changeable Message Sign

Note: All Changeable Message Signs (CMS) can display three messages: EXACT COINS, CHANGE RECEIPTS, E-PASS ONLY

INNOVATION WAY  
 ON RAMP  
 R03  
 PID: 431

INNOVATION WAY  
 OFF RAMP  
 R04  
 PID: 432

Reports to Beachline Mainline Toll Plaza

T:\OCEA\OCEA MANUAL\STol Facilities Reference Book\2016 Tolls Manual - 3/10/16-CP

# Poinciana Parkway



# Mainline Toll Plaza

LEGEND

*For Lane Designations for all Plazas*

*AET - Express Lanes*



To US 17-92

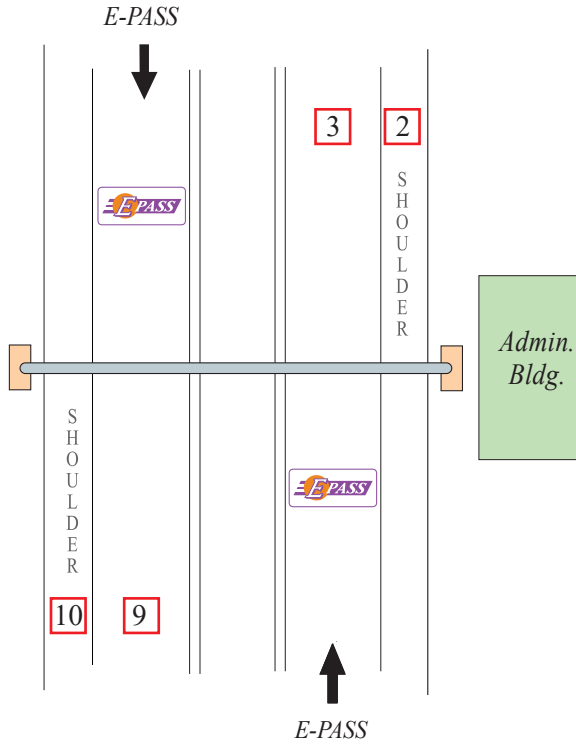

To Marigold Avenue,  
Cypress Parkway



ORG-ID: 2	PID: 429
FACILITY: SR 538 - MARIGOLD	

LANES OF EQUIPMENT  
 2 Express E-PASS (E-PASS only)

To Marigold Avenue,  
US 17-92

To KOA Street,  
Cypress Parkway

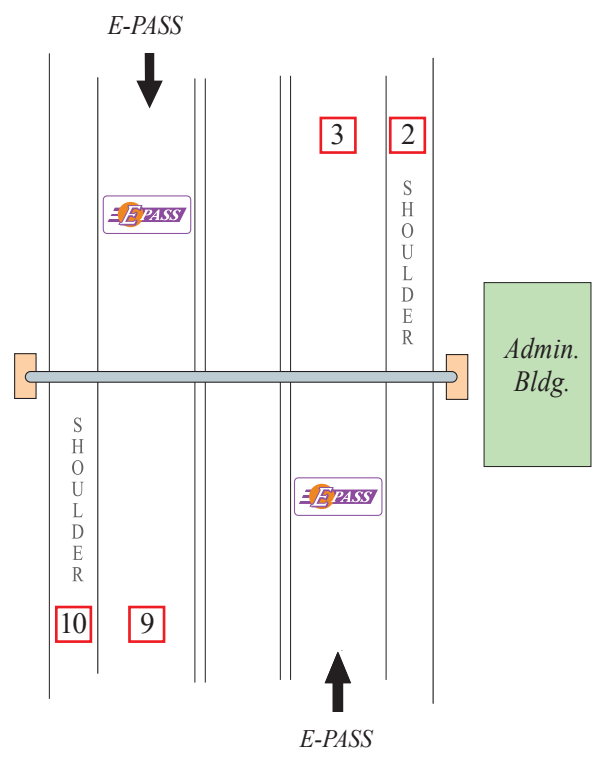

ORG-ID: 2	PID: 430
FACILITY: SR 538 - KOA	

LANES OF EQUIPMENT  
 2 Express E-PASS (E-PASS only)



# Goldenrod Road Extension



## Mainline Toll Plaza

LEGEND

*For Lane Designations for all Plazas*

*CA - Exact Coin with E-PASS*

*MA - Change Receipts (Staffed) with E-PASS*

*MCA - Booth with Manual Lane Terminal,  
Automatic Coin Machine and E-PASS*

To Orlando International Airport  
SR 528 - (Beachline Expressway)

Lee Vista Blvd.  
To SR 15 (Hoffner Ave.)

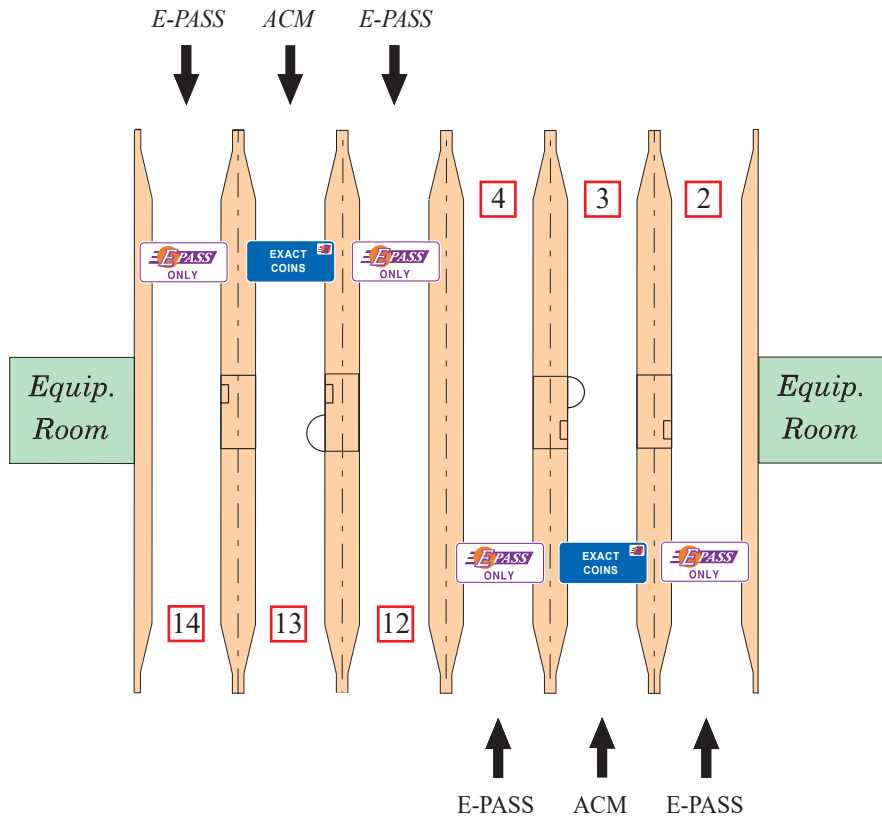

ORG-ID: 18	PID: 349
FACILITY: SR 551 - GOLDENROD	

LANES OF EQUIPMENT  
 2 Automatic Coin Machines with  
 E-PASS (ACM)  
 4 Dedicated E-PASS (E-PASS only)

Reports to Curry Ford Mainline Toll Plaza

# Osceola Parkway



## Mainline Toll Plazas and Associated Ramps

LEGEND

*For Lane Designations for all Plazas*

*CA - Exact Coin with E-PASS*

*MA - Change Receipts (Staffed) with E-PASS*

*MCA - Booth with Manual Lane Terminal,  
Automatic Coin Machine and E-PASS*

↑  
To SR 417,  
I-4 / Disney World

↓  
To US 441,  
Florida's Turnpike

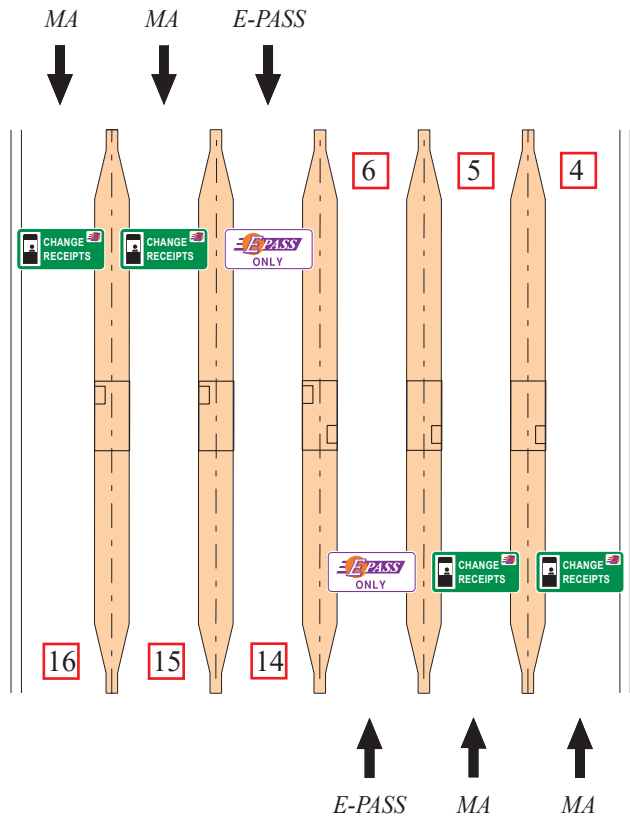

ORG-ID: 17	PID: 350
FACILITY: SR552 - Shingle Creek	

LANES OF EQUIPMENT  
 4 Staffed Booths with E-PASS (MA)  
 2 Booths with E-PASS

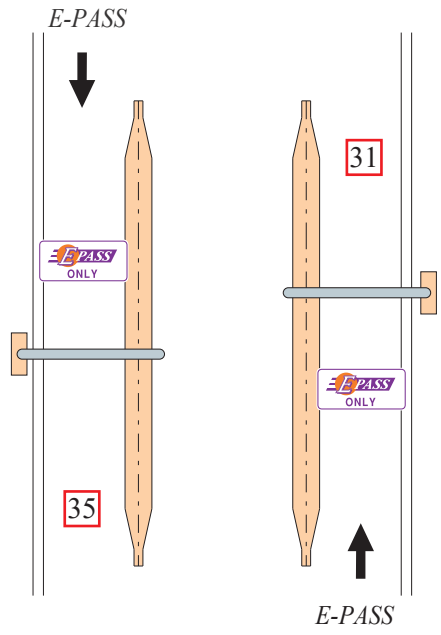
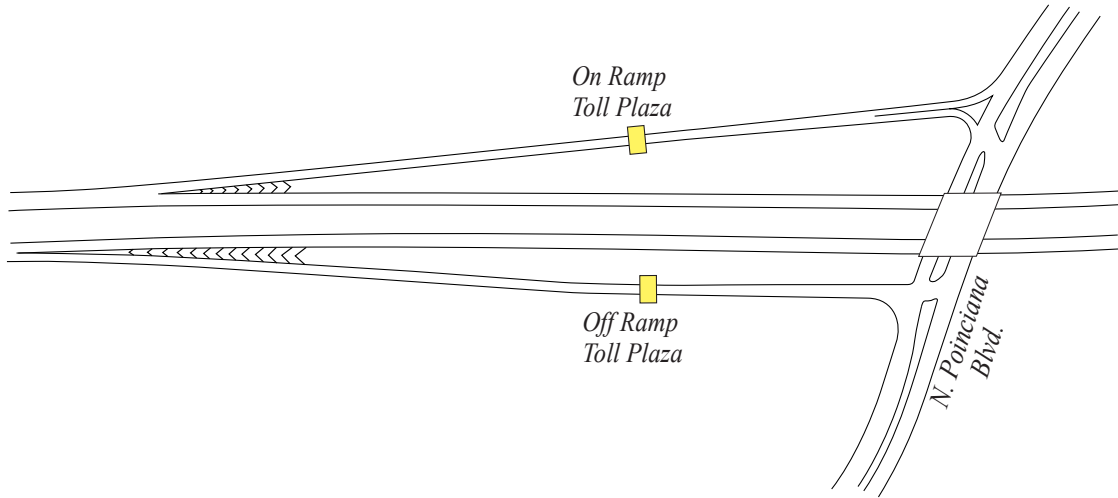

ORG-ID: 17  
FACILITY: CR522 - Shingle Creek

POINCIANA  
OFF RAMP  
R02  
PID: 352

POINCIANA  
ON RAMP  
R01  
PID: 351

Reports to Shingle Creek Mainline Toll Plaza

T:\OCEA\OCEA MANUAL\STol Facilities Reference Book\2016 Tolls Manual - 6/28/16-CP